

CECW-EG

DEPARTMENT OF THE ARMY
U.S. Army Corps of Engineers
Washington, DC 20314-1000

EM 1110-2-1913

Manual
No. 1110-2-1913

30 April 2000

Engineering and Design
DESIGN AND CONSTRUCTION OF LEVEES

- 1. Purpose.** The purpose of this manual is to present basic principles used in the design and construction of earth levees.
- 2. Applicability.** This manual applies to all Corps of Engineers Divisions and Districts having responsibility for the design and construction of levees.
- 3. Distribution.** This manual is approved for public release; distribution is unlimited.
- 4. General.** This manual is intended as a guide for designing and constructing levees and not intended to replace the judgment of the design engineer on a particular project.

FOR THE COMMANDER:

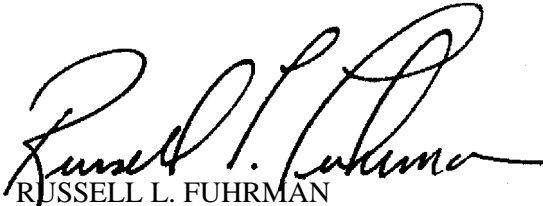

RUSSELL L. FUHRMAN
Major General, USA
Chief of Staff

This manual supersedes EM 1110-2-1913, dated 31 March 1978.



EM 1110-2-1913
30 April 2000

US Army Corps
of Engineers
ENGINEERING AND DESIGN

Design and Construction of Levees

ENGINEER MANUAL

AVAILABILITY

Electronic copies of this and other U.S. Army Corps of Engineers (USACE) publications are available on the Internet at <http://www.usace.army.mil/inet/usace-docs/>. This site is the only repository for all official USACE engineer regulations, circulars, manuals, and other documents originating from HQUSACE. Publications are provided in portable document format (PDF).

Engineering and Design
DESIGN AND CONSTRUCTION OF LEVEES

Table of Contents

Subject	Paragraph	Page
Chapter 1		
Introduction		
Purpose	1-1	1-1
Applicability	1-2	1-1
References	1-3	1-1
Objective	1-4	1-1
General Considerations	1-5	1-1
Chapter 2		
Field Investigations		
Preliminary and Final Stage	2-1	2-1
<i>Section I</i>		
<i>Geological Study</i>		
Scope	2-2	2-1
Office Study	2-3	2-2
Field Survey	2-4	2-3
Report	2-5	2-3
<i>Section II</i>		
<i>Subsurface Exploration</i>		
General	2-6	2-3
Phase 1 Exploration	2-7	2-3
Phase 2 Exploration	2-8	2-3
Borings	2-9	2-4
Geophysical Exploration	2-10	2-4
<i>Section III</i>		
<i>Field Testing</i>		
Preliminary Strength Estimates	2-11	2-6
Vane Shear Tests	2-12	2-6
Groundwater and Pore Pressure Observations	2-13	2-7
Field Pumping Tests	2-14	2-7

Subject	Paragraph	Page
Chapter 3		
Laboratory Testing		
General	3-1	3-1
Classification and Water Content Determinations	3-2	3-2
<i>Section I</i>		
<i>Fine-Grained Soils</i>		
Use of Correlations	3-3	3-2
Shear Strength	3-4	3-7
Consolidation	3-5	3-7
Permeability	3-6	3-7
Compaction Tests	3-7	3-7
<i>Section II</i>		
<i>Coarse-Grained Soils</i>		
Shear Strength	3-8	3-8
Permeability	3-9	3-8
Density Testing of Pervious Fill	3-10	3-8
Chapter 4		
Borrow Areas		
General	4-1	4-1
Available Borrow Material	4-2	4-1
General Layout	4-3	4-1
Design and Utilization	4-4	4-2
Chapter 5		
Seepage Control		
<i>Section I</i>		
<i>Foundation Underseepage</i>		
General	5-1	5-1
Cutoffs	5-2	5-1
Riverside Blankets	5-3	5-1
Landside Seepage Berms	5-4	5-2
Pervious Toe Trench	5-5	5-3
Pressure Relief Wells	5-6	5-5
<i>Section II</i>		
<i>Seepage Through Embankments</i>		
General	5-7	5-8
Pervious Toe Drain	5-8	5-9
Horizontal Drainage Layers	5-9	5-10
Inclined Drainage Layers	5-10	5-10
Design of Drainage Layers	5-11	5-10
Compaction of Drainage Layers	5-12	5-10

Subject	Paragraph	Page
Chapter 6		
Slope Design and Settlement		
<i>Section I</i>		
<i>Embankment Stability</i>		
Embankment Geometry	6-1	6-1
Standard Levee Sections and Minimum Levee Section	6-2	6-1
Effects of Fill Characteristics and Compaction	6-3	6-2
<i>Section II</i>		
<i>Stability Analyses</i>		
Methods of Analysis	6-4	6-3
Conditions Requiring Analysis	6-5	6-3
Minimum Acceptable Factors of Safety	6-6	6-4
Measures to Increase Stability	6-7	6-4
Surface Slides	6-8	6-5
<i>Section III</i>		
<i>Settlement</i>		
General	6-9	6-6
Settlement Analyses	6-10	6-6
Chapter 7		
Levee Construction		
<i>Section I</i>		
<i>Levee Construction Methods</i>		
Classification of Methods	7-1	7-1
<i>Section II</i>		
<i>Foundations</i>		
Foundation Preparation and Treatment	7-2	7-1
Methods of Improving Stability	7-3	7-3
<i>Section III</i>		
<i>Embankments</i>		
Embankment Construction Control	7-4	7-5
Embankment Zoning	7-5	7-6
Protection of Riverside Slopes	7-6	7-6
Chapter 8		
Special Features		
<i>Section I</i>		
<i>Pipelines and Other Utility Line Crossing Levees</i>		
General Considerations	8-1	8-1
General Considerations for Pipelines Crossing Through or Under Levees	8-2	8-2
General Consideration for Pipelines Crossing Over Levees	8-3	8-3

Subject	Paragraph	Page
Pipe Selection	8-4	8-3
Antiseepage Devices	8-5	8-4
Closure Devices	8-6	8-6
Camber	8-7	8-6
Installation Requirements	8-8	8-7
<i>Section II</i>		
<i>Access Roads and Ramps</i>		
Access Roads	8-9	8-10
Ramps	8-10	8-10
<i>Section III</i>		
<i>Levee Enlargement</i>		
General	8-11	8-12
Earth-Levee Enlargement	8-12	8-12
Floodwall-Levee Enlargement	8-13	8-13
<i>Section IV</i>		
<i>Junction with Concrete Closure Structures</i>		
General	8-14	8-15
Design Considerations	8-15	8-17
<i>Section V</i>		
<i>Other Special Features</i>		
Construction of Ditches Landside of Levee	8-16	8-17
Levee Vegetation Management	8-17	8-17

Appendix A
References

Appendix B
Mathematical Analysis of Underseepage and Substratum Pressure

Appendix C
Design of Seepage Berms

Appendix D
Filter Design

Appendix E
Drainage Trench

Appendix F
Emergency Flood Protection

Appendix G
Use of Soil Cement for Levee Protection

Appendix H Notation

List of Tables

No.	Title	Page
1-1.	Major and Minimum Requirements	1-2
1-2.	Classification of Levees According to Use	1-3
2-1.	Factors Requiring Intensive Field Investigations and Design Studies	2-1
2-2.	Stages of Field Investigations	2-2
2-3.	Types of Contour Maps	2-3
2-4.	Phase I Boring and Sampling Techniques	2-4
2-5.	Applicable Geophysical Methods of Exploration	2-6
2-6.	Preliminary Appraisal of Foundation Strengths	2-7
3-1.	Laboratory Testing of Fine-Grained Cohesive Soils	3-1
3-2.	Laboratory Testing of Pervious Materials	3-2
6-1.	Minimum Factors of Safety - Levee Slope Stability	6-4
7-1.	Classification According to Construction Method of Levees Composed of Imperious and Semiperious Materials	7-2
7-2.	Embankment Construction Deficiencies	7-6
8-1.	Criteria for Pipelines Crossing Levees	8-2
B-1.	Factors Involved in Seepage Analyses	B-2
B-2.	Methods for Determination of Design Parameters	B-3
B-3.	Examples of Transformation Procedure	B-5
C-1.	Summary of Distances to Effective Source of Seepage, Effective Lengths of Riverside Blankets, and Vertical Permeability of Riverside Blanket Materials at the Crest of 1950 High Water	C-2
C-2.	Examples of Design of Seepage Berms	C-7
D-1.	Categories of Base Soil Materials	D-2
D-2.	Criteria for Filters	D-3
D-3.	D ₁₀ and D ₉₀ Limits for Preventing Segregation	D-3
F-1.	Matching Pipe Size to Pump Size	F-11
F-2.	Crisafulli Pumps - Model CP 2 inch to 24 inch	F-12
F-3.	Marlow Self Priming Centrifugal Pumps	F-12
F-4.	Capacity of Corrugated Metal Pipe Culverts	F-14
G-1.	Initial Cement Content for Moisture Density Tests	G-3
G-2.	Durability Test Weight Loss Criteria	G-4
G-3.	Unconfined Compressive Strength Criteria (ASTM D 1633)	G-5

List of Figures

No.	Figure	Page
3-1.	Plasticity chart (ENG Form 4334	3-3
3-2.	Example correlations of strength characteristic for fine-grained soils	3-4
3-3.	Example correlations for consolidation characteristics of fine-grained soils (after Kapp, ref. A-5e)	3-5
3-4.	Comparisons of Atterberg limits and natural water content	3-7
3-5.	Example correlations for properties of coarse-grained soils	3-9
4-1.	Plan of typical levee and borrow areas with traverse and foreshore	4-3

No.	Figure	Page
5-1.	Example of incorrect and correct berm length according to existing foundation conditions	5-2
5-2.	Typical partially penetrating pervious toe trench	5-4
5-3.	Typical pervious toe trench with collector pipe (Figure 5-6 shows trench details)	5-5
5-4.	Pervious toe trench located beneath landward slope	5-5
5-5.	Special equipment for compacting sand in pervious toe trenches	5-6
5-6.	Pervious toe trench with collector pipe	5-7
5-7.	Typical relief well	5-8
5-8.	Embankment with through seepage	5-9
5-9.	Use of horizontal and inclined drainage layers to control seepage through an embankment	5-11
8-1.	Typical sections, drainage structures through levees	8-5
8-2.	Typical precast conduit (levees)	8-5
8-3.	Details of pipeline levee crossing	8-9
8-4.	Example of levee turnout	8-11
8-5.	Example of levee turnaround	8-11
8-6.	Enlargements	8-13
8-7.	I-type floodwall-levee enlargement	8-14
8-8.	Inverted T-type floodwall-levee enlargement	8-15
8-9.	Junction of levee and drainage structure	8-16
B-1.	Illustration of symbols used in Appendix B	B-4
B-2.	Transformation of top strata	B-6
B-3.	Effective seepage exit length for $L_3 = 4$ and $d = 100$ m or 100 ft	B-8
B-4.	Relation between x_3 for blocked or open exits and x_3 for $L_3 = 4$	B-10
B-5.	Equations for computation of underseepage flow and substratum pressures for Cases 1 through 4	B-14
B-6.	Equations for computation of underseepage flow and substratum pressures for Cases 5 and 6	B-15
B-7.	Equations for computation of underseepage and substratum pressures for Case 7	B-16
B-8.	Ratio between head landward of levee and head at landside toe of levee for levees found on semipervious to stratum underlain by a pervious substratum	B-18
C-1.	Design of landside seepage berms on impervious top stratum	C-4
D-1.	Analysis of a gap-graded material	D-5
D-2.	Illustration of the design of a graded filter	D-7
E-1.	Formulas and design curves for drainage trenches (ref. A-3b (2))	E-2
E-2.	Example of design of a drainage trench	E-5
F-1.	Sandbag barrier	F-5
F-2.	Flash board and box levee	F-6
F-3.	Placement of polyethylene sheeting on temporary levee	F-7
F-4.	Placement of polyethylene sheeting in the wet	F-8
F-5.	Prefabricated rubber pipe stoppers for outlet opening of a manhole	F-16
F-6.	Prefabricated rubber pipe stoppers for outlet opening of a manhole	F-16
F-7.	Typical manhole	F-17
F-8.	Adapting manhole for use as emergency pumping station	F-18
F-9.	Sealing top of manhole with wood	F-19
F-10.	Treatment of bottom of manhole	F-20
F-11.	Suction line to pump from manhole	F-21
F-12.	Ringling sand boils	F-23

No.	Figure	Page
G-1.	Typical moisture-density curve	G-4
G-2.	Stair-step method of slope protection	G-6
G-3.	Relationship of slope, facing thickness, layer thickness, and horizontal layer width	G-7
G-4.	Typical pug mill central plant	G-10
G-5.	Mixing paddles of a twin-shaft, continuous-flow central mixing plant	G-10
G-6.	Typical construction sequence	G-11
G-7.	“Deadman” pulling vibratory sheepsfoot roller up the slope	G-12
G-8.	Transverse single-shaft rotary mixer	G-14
G-9.	Bulk mechanical spreader	G-15

Chapter 1 Introduction

1-1. Purpose

The purpose of this manual is to present basic principles used in the design and construction of earth levees.

1-2. Applicability

This manual applies to all Corps of Engineers Divisions and Districts having responsibility for designing and constructing levees.

1-3. References

Appendix A contains a list of required and related publications pertaining to this manual. Unless otherwise noted, all references are available on interlibrary loan from the Research Library, ATTN: CEWES-IM-MI-R, U.S. Army Engineer Waterways Experiment Station, 3909 Halls Ferry Road, Vicksburg, MS 39180-6199.

1-4. Objective

The objective of this manual is to develop a guide for design and construction of levees. The manual is general in nature and not intended to supplant the judgment of the design engineer on a particular project.

1-5. General Considerations

a. General

(1) The term levee as used herein is defined as an embankment whose primary purpose is to furnish flood protection from seasonal high water and which is therefore subject to water loading for periods of only a few days or weeks a year. Embankments that are subject to water loading for prolonged periods (longer than normal flood protection requirements) or permanently should be designed in accordance with earth dam criteria rather than the levee criteria given herein.

(2) Even though levees are similar to small earth dams they differ from earth dams in the following important respects: (a) a levee embankment may become saturated for only a short period of time beyond the limit of capillary saturation, (b) levee alignment is dictated primarily by flood protection requirements, which often results in construction on poor foundations, and (c) borrow is generally obtained from shallow pits or from channels excavated adjacent to the levee, which produce fill material that is often heterogeneous and far from ideal. Selection of the levee section is often based on the properties of the poorest material that must be used.

(3) Numerous factors must be considered in levee design. These factors may vary from project to project, and no specific step-by-step procedure covering details of a particular project can be established. However, it is possible to present general, logical steps based on successful past projects that can be followed in levee design and can be used as a base for developing more specific procedures for any particular project. Such a procedure is given in Table 1-1. Information for implementing this procedure is presented in subsequent chapters.

Table 1-1
Major and Minimum Requirements

Step	Procedure
1	Conduct geological study based on a thorough review of available data including analysis of aerial photographs. Initiate preliminary subsurface explorations.
2	Analyze preliminary exploration data and from this analysis establish preliminary soil profiles, borrow locations, and embankment sections.
3	Initiate final exploration to provide: a. Additional information on soil profiles. b. Undisturbed strengths of foundation materials. c. More detailed information on borrow areas and other required excavations.
4	Using the information obtained in Step 3: a. Determine both embankment and foundation soil parameters and refine preliminary sections where needed, noting all possible problem areas. b. Compute rough quantities of suitable material and refine borrow area locations.
5	Divide the entire levee into reaches of similar foundation conditions, embankment height, and fill material and assign a typical trial section to each reach.
6	Analyze each trial section as needed for: a. Underseepage and through seepage. b. Slope stability. c. Settlement. d. Trafficability of the levee surface.
7	Design special treatment to preclude any problems as determined from Step 6. Determine surfacing requirements for the levee based on its expected future use.
8	Based on the results of Step 7, establish final sections for each reach.
9	Compute final quantities needed; determine final borrow area locations.
10	Design embankment slope protection.

(4) The method of construction must also be considered. In the past levees have been built by methods of compaction varying from none to carefully controlled compaction. The local economic situation also affects the selection of a levee section. Traditionally, in areas of high property values, high land use, and good foundation conditions, levees have been built with relatively steep slopes using controlled compaction, while in areas of lower property values, poor foundations, or high rainfall during the construction season, uncompacted or semicompacted levees with flatter slopes are more typical. This is evident by comparing the steep slopes of levees along the industrialized Ohio River Valley with levees along the Lower Mississippi River which have much broader sections with gentler slopes. Levees built with smaller sections and steeper slopes generally require more comprehensive investigation and analysis than do levees with broad sections and flatter slopes whose design is more empirical. Where rainfall and foundation conditions permit, the trend in design of levees is toward sections with steeper slopes. Levee maintenance is another factor that often has considerable influence on the selection of a levee section.

b. Levee types according to location. Levees are broadly classified according to the area they protect as either urban or agricultural levees because of different requirements for each. As used in this manual, urban and agricultural levees are defined as follows:

(1) Urban levees. Levees that provide protection from flooding in communities, including their industrial, commercial, and residential facilities.

(2) Agricultural levees. Levees that provide protection from flooding in lands used for agricultural purposes.

c. *Levee types according to use.* Some of the more common terms used for levees serving a specific purpose in connection with their overall purpose of flood protection are given in Table 1-2.

Table 1-2
Classification of Levees According to Use

Type	Definition
Mainline and tributary levees	Levees that lie along a mainstream and its tributaries, respectively.
Ring levees	Levees that completely encircle or "ring" an area subject to inundation from all directions.
Setback levees	Levees that are built landward of existing levees, usually because the existing levees have suffered distress or are in some way being endangered, as by river migration.
Sublevees	Levees built for the purpose of underseepage control. Sublevees encircle areas behind the main levee which are subject, during high-water stages, to high uplift pressures and possibly the development of sand boils. They normally tie into the main levee, thus providing a basin that can be flooded during high-water stages, thereby counterbalancing excess head beneath the top stratum within the basin. Sublevees are rarely employed as the use of relief wells or seepage berms make them unnecessary except in emergencies.
Spur levees	Levees that project from the main levee and serve to protect the main levee from the erosive action of stream currents. Spur levees are not true levees but training dikes.

d. *Causes of Levee Failures.* The principal causes of levee failure are

- (1) Overtopping.
- (2) Surface erosion.
- (3) Internal erosion (piping).
- (4) Slides within the levee embankment or the foundation soils.

Chapter 2 Field Investigations

2-1. Preliminary and Final Stage

Many field investigations are conducted in two stages: a preliminary stage and a final (design) stage. Normally, a field investigation in the preliminary stage is not extensive since its purpose is simply to provide general information for project feasibility studies. It will usually consist of a general geological reconnaissance with only limited subsurface exploration and simple soil tests. In the design stage, more comprehensive exploration is usually necessary, with more extensive geological reconnaissance, borings, test pits, and possibly geophysical studies. The extent of the field investigation depends on several factors. Table 2-1 lists these factors together with conditions requiring extensive field investigations and design studies. Sometimes field tests such as vane shear tests, groundwater observations, and field pumping tests are necessary. Table 2-2 summarizes, in general, the broad features of geologic and subsurface investigations.

Section I Geological Study

2-2. Scope

A geological study usually consists of an office review of all available geological information on the area of interest and an on-site (field) survey. Since most levees are located in alluvial floodplains, the distribution and engineering characteristics of alluvial deposits in the vicinity of proposed levees must be evaluated. The general distribution, nature, and types of floodplain deposits are directly related to changes in the depositional environment of the river and its tributaries. Each local area in the floodplain bears traces of river action, and the alluvial deposits there may vary widely from those in adjacent areas. The general nature and distribution of sediments can be determined through a study of the pattern of local river changes as a basis for selection of boring locations.

**Table 2-1
Factors Requiring Intensive Field Investigations and Design Studies**

Factor	Field Investigations and Design Studies Should be more Extensive Where:
Previous experience	There is little or no previous experience in the area particularly with respect to levee performance
Consequences of failure	Consequences of failure involving life and property are great (urban areas for instance)
Levee height	Levee heights exceed 3 m (10 ft)
Foundation conditions	Foundation soils are weak and compressible Foundation soils are highly variable along the alignment Potential underseepage problems are severe Foundation sands may be liquefaction susceptible
Duration of high water	High water levels against the levee exist over relatively long periods
Borrow materials	Available borrow is of low quality, water contents are high, or borrow materials are variable along the alignment
Structure in levees	Reaches of levees are adjacent to concrete structures

Table 2-2
Stages of Field Investigations

1. Investigation or analysis produced by field reconnaissance and discussion with knowledgeable people is adequate for design where:
 - a. Levees are 3 m (10 ft) or less in height.
 - b. Experience has shown foundations to be stable and presenting no underseepage problems.Use standard levee section developed through experience.
 2. *Preliminary geological investigation:*
 - a. *Office study:* Collection and study of
 - (1) Topographic, soil, and geological maps.
 - (2) Aerial photographs.
 - (3) Boring logs and well data.
 - (4) Information on existing engineering projects.
 - b. *Field survey:* Observations and geology of area, documented by written notes and photographs, including such features as:
 - (1) Riverbank slopes, rock outcrops, earth and rock cuts or fills.
 - (2) Surface materials.
 - (3) Poorly drained areas.
 - (4) Evidence of instability of foundations and slopes.
 - (5) Emerging seepage.
 - (6) Natural and man-made physiographic features.
 3. *Subsurface exploration and field testing and more detailed geologic study:* Required for all cases except those in 1 above. Use to decide the need for and scope of subsurface exploration and field testing:
 - a. *Preliminary phase:*
 - (1) Widely but not necessarily uniformly spaced disturbed sample borings (may include split-spoon penetration tests).
 - (2) Test pits excavated by backhoes, dozers, or farm tractors.
 - (3) Geophysical surveys (e.g., seismic or electrical resistivity) or cone penetrometer test to interpolate between widely spaced borings.
 - (4) Borehole geophysical tests.
 - b. *Final phase:*
 - (1) Additional disturbed sample borings.
 - (2) Undisturbed sample borings.
 - (3) Field vane shear tests for special purposes.
 - (4) Field pumping tests (primarily in vicinity of structures).
 - (5) Water table observations (using piezometers) in foundations and borrow areas.
-

2-3. Office Study

The office study begins with a search of available information, such as topographic, soil, and geological maps and aerial photographs. Pertinent information on existing construction in the area should be obtained. This includes design, construction, and performance data on utilities, highways, railroads, and hydraulic structures. Available boring logs should be secured. Federal, state, county, and local agencies and private organizations should be contacted for information. The GIS (Geographic Information System) became used extensively in major range of projects. It is capable of compiling large multi-layered data bases, interactively analyzing and manipulating those data bases, and generating and displaying resultant thematic maps and statistics to aid in engineering management decisions. Federal, state, and private organizations provide free internet access to such systems. Table 2-3 shows some of the contour maps GIS systems provide.

Table 2-3
Types of Contour Maps

Contour Type	Uses	
Geologic Structure Elevation Maps	Contour maps in which each line represents the elevation of the top of a geological material or facies	GIS can produce these maps based on the selection of one of four structure parameters
Geologic formations	Contours the top of a user-defined geologic formation	
Blow counts	Contours the top of a structure identified by the first, second, or third occurrence of a specified range of blow counts	A blow count is defined as the number of standard blows required to advance a sampling device into 150 mm (6 in.) of soil
Soil units	Contours the top of a structure identified by the first, second, or third occurrence of one or more soil types	
Fluid level elevation - water table contour maps	Show elevation data (hydraulic head) from unconfined water bearing units where the fluid surface is in equilibrium with atmospheric pressure	Help to evaluate the direction of ground water flow and the energy gradient under which it is flowing
Fluid level elevation - potentiometric surface maps	Show elevation data from confined water bearing units where the fluid surface is under pressure because of the presence of a confining geologic unit	
Hydraulic conductivity	Show the rate of water flow through soil under a unit gradient per unit area	GIS stores vertical and horizontal conductivity data for up to five water bearing zones
	Portray the variations in the water-bearing properties of materials which comprise each water bearing zone	Necessary parameter for computing ground water flow rates, which is important since groundwater velocity exerts a major control on plume shape

2-4. Field Survey

The field survey is commenced after becoming familiar with the area through the office study. Walking the proposed alignment and visiting proposed borrow areas are always an excellent means of obtaining useful information. Physical features to be observed are listed in Table 2-2. These items and any others of significance should be documented by detailed notes, supplemented by photographs. Local people or organizations having knowledge of foundation conditions in the area should be interviewed.

2-5. Report

When all available information has been gathered and assimilated, a report should be written that in essence constitutes a geological, foundation, and materials evaluation report for the proposed levee. All significant factors that might affect the alignment and/or design should be clearly pointed out and any desirable changes in alignment suggested. All maps should be to the same scale, and overlays of maps, e.g., topography and soil type, aerial photograph and topography, etc., to facilitate information correlation is desirable. The development of a project GIS will simplify and expedite consistently georeferenced map products.

Section II
Subsurface Exploration

2-6. General

a. Because preliminary field investigations usually involve only limited subsurface exploration, only portions of the following discussion may be applicable to the preliminary stage, depending on the nature of the project.

b. The subsurface exploration for the design stage generally is accomplished in two phases, which may be separate in sequence, or concurrent: (1) Phase 1, the main purpose of which is to better define the geology of the area, the soil types present and to develop general ideas of soil strengths and permeabilities; (2) Phase 2, provides additional information on soil types present and usually includes the taking of undisturbed samples for testing purposes.

2-7. Phase 1 Exploration

Phase 1 exploration consists almost entirely of disturbed sample borings and perhaps test pits excavated with backhoes, dozers, farm tractors, etc., as summarized in Table 2-4, but may also include geophysical surveys which are discussed later.

Table 2-4
Phase I Boring and Sampling Techniques

Technique	Remarks
1. Disturbed sample borings	
a. Split- spoon or standard penetration test	1-a. Primarily for soil identification but permits estimate of shear strength of clays and crude estimate of density of sands; see paragraph 5-3d of EM 1110-1-1906 Preferred for general exploration of levee foundations; indicates need and locations for undisturbed samples
b. Auger borings	1-b. Bag and jar samples can be obtained for testing
2. Test pits	2. Use backhoes, dozers, and farm tractors
3. Trenches	3. Occasionally useful in borrow areas and levee foundations

2-8. Phase 2 Exploration

Phase 2 subsurface exploration consists of both disturbed and undisturbed sample borings and also may include geophysical methods. Undisturbed samples for testing purposes are sometimes obtained by handcarving block samples from test pits but more usually by rotary and push-type drilling methods (using samplers such as the Denison sampler in extremely hard soils or the thin-walled Shelby tube fixed piston sampler in most soils). Samples for determining consolidation and shear strength characteristics and values of density and permeability should be obtained using undisturbed borings in which 127-mm- (5-in.-) diameter samples are taken in cohesive materials and 76.2-mm- (3-in.-) diameter samples are taken in cohesionless materials. EM 1110-1-1906 gives details of drilling and sampling techniques.

2-9. Borings

a. Location and spacing. The spacing of borings and test pits in Phase 1 is based on examination of airphotos and geological conditions determined in the preliminary stage or known from prior experience in the area, and by the nature of the project. Initial spacing of borings usually varies from 60 to 300 m (nominally 200 to 1,000 ft) along the alignment, being closer spaced in expected problem areas and wider spaced in nonproblem areas. The spacing of borings should not be arbitrarily uniform but rather should be based on available geologic information. Borings are normally laid out along the levee centerline but can be staggered along the alignment in order to cover more area and to provide some data on nearby borrow materials. At least one boring should be located at every major structure during Phase 1. In Phase 2, the locations of additional general sample borings are selected based on Phase 1 results. Undisturbed sample borings are located where data on soil shear strength are most needed. The best procedure is to group the foundation profiles developed on the basis of geological studies and exploration into reaches of similar conditions and then locate undisturbed sample borings so as to define soil properties in critical reaches.

b. Depth. Depth of borings along the alignment should be at least equal to the height of proposed levee at its highest point but not less than 3 m (nominally 10 ft). Boring depths should always be deep enough to provide data for stability analyses of the levee and foundation. This is especially important when the levee is located near the riverbank where borings must provide data for stability analyses involving both levee foundation and riverbank. Where pervious or soft materials are encountered, borings should extend through the permeable material to impervious material or through the soft material to firm material. Borings at structure locations should extend well below invert or foundation elevations and below the zone of significant influence created by the load. The borings must be deep enough to permit analysis of approach and exit channel stability and of underseepage conditions at the structure. In borrow areas, the depth of exploration should extend several feet below the practicable or allowable borrow depth or to the groundwater table. If borrow is to be obtained from below the groundwater table by dredging or other means, borings should be at least 3 m (nominally 10 ft) below the bottom of the proposed excavation.

2-10. Geophysical Exploration

a. It is important to understand the capabilities of the different geophysical methods, so that they may be used to full advantage for subsurface investigations. Table 2-5 summarizes those geophysical methods most appropriate to levee exploration. These methods are a fairly inexpensive means of exploration and are very useful for correlating information between borings which, for reasons of economy, are spaced at fairly wide intervals. Geophysical data must be interpreted in conjunction with borings and by qualified, experienced personnel. Because there have been significant improvements in geophysical instrumentation and interpretation techniques in recent years, more consideration should be given to their use.

b. Currently available geophysical methods can be broadly subdivided into two classes: those accomplished entirely from the ground surface and those which are accomplished from subsurface borings. Applicable geophysical ground surface exploration methods include: (1) seismic methods, (2) electrical resistivity, (3) natural potential (SP) methods, (4) electromagnetic induction methods, and (5) ground penetrating radar. Information obtained from seismic surveys includes material velocities, delineation of interfaces between zones of differing velocities, and the depths to these interfaces. The electrical resistivity survey is used to locate and define zones of different electrical properties such as pervious and impervious zones or zones of low resistivity such as clayey strata. Both methods require differences in properties of levee and/or foundation materials in order to be effective. The resistivity method requires a resistivity contrast between materials being located, while the seismic method requires contrast in wave transmission velocities. Furthermore, the seismic refraction method requires that any underlying stratum transmit waves

**Table 2-5
Applicable Geophysical Methods of Exploration^a**

	Top of Bedrock	Fault Detection	Suspected Voids or Cavity Detection	In Situ Elastic Moduli (Velocities)	Material Boundaries, Dip, ...	Subsurface Conduits and Vessels	Landfill Boundaries
Seismic Refraction	W	S		W	S		
Seismic Reflection	S	S	S		W		
Natural Potential (SP)						S	
DC Resistivity	S	S	S		S	S	W
Electro- Magnetics		S			S	W	W
Ground Penetrating Radar	S	S	S		S	S	S
Gravity		S	S		S		
Magnetics		S					S

W - works well in most materials and natural configurations.

S - works under special circumstances of favorable materials or configurations.

Blank - not recommended.

^a After EM 1110-1-1802.

at a higher velocity than the overlying stratum. Difficulties arise in the use of the seismic method if the surface terrain and/or layer interfaces are steeply sloping or irregular instead of relatively horizontal and smooth. Therefore, in order to use these methods, one must be fully aware of what they can and cannot do. EM 1110-1-1802 describes the use of both seismic refraction and electrical resistivity. Telford et al. (1990) is a valuable, general text on geophysical exploration. Applicable geophysical exploration methods based on operation from the ground surface are summarized in Table 2-5. A resistivity survey measures variations in potential of an electrical field within the earth by a surface applied current. Variation of resistivity with depth is studied by changing electrode spacing. The data is then interpreted as electrical resistivity expressed as a function of depth. (Telford et al. 1990; EM 1110-1-1802)

c. Downhole geophysical logging can be used with success in correlating subsurface soil and rock stratification and in providing quantitative engineering parameters such as porosity, density, water content, and moduli. They also provide valuable data for interpreting surface geophysical data. The purpose in using these methods is not only to allow cost savings, but the speed, efficiency and often much more reliable information without lessening the quality of the information obtained. Electromagnetic (EM) induction surveys use EM transmitters that generate currents in subsurface materials. These currents produce secondary magnetic fields detectable at the surface. Simple interpretation techniques are advantages of these methods, making EM induction techniques particularly suitable for horizontal profiling. EM horizontal profiling surveys are useful for detecting anomalous conditions along the centerline of proposed levee construction or along existing levees. Self potential (SP) methods are based on change of potential of ground by human action or alteration of original condition. Four electric potentials due to fluid flow, electrokinetic or streaming, liquid junction or diffusion, mineralizaion, and solution differing concentration, are known.

The qualitative application of this method is relatively simple and serves best for detection of anomalous seepage through, under, or around levees (Butler and Llopis, 19909; EM 1110-1-1802).

Section III
Field Testing

2-11. Preliminary Strength Estimates

It is often desirable to estimate foundation strengths during Phase 1 of the exploration program. Various methods of preliminary appraisal are listed in Table 2-6.

Table 2-6
Preliminary Appraisal of Foundation Strengths

Method	Remarks
1. Split-spoon penetration resistance	1-a. Unconfined compressive strength in hundreds kPa (or tons per square foot), of clay is about 1/8 of number of blows per 0.3 m (1 ft), or N/8, but considerable scatter must be expected. Generally not helpful where N is low 1-b. In sands, N values less than about 15 indicate low relative densities. N values should not be used to estimate relative densities for earthquake design
2. Natural water content of disturbed or general type samples	2. Useful when considered with soil classification, and previous experience is available
3. Hand examination of disturbed samples	3. Useful where experienced personnel are available who are skilled in estimating soil shear strengths
4. Position of natural water contents relative to liquid and plastic limits	4-a. Useful where previous experience is available 4-b. If natural water content is close to plastic limit foundation shear strength should be high 4-c. Natural water contents near liquid limit indicate sensitive soil usually with low shear strengths
5. Torvane or pocket penetrometer tests on intact portions of general samples or on walls of test trenches	5. Easily performed and inexpensive but may underestimate actual values ; useful only for preliminary strength classifications

2-12. Vane Shear Tests

Where undisturbed samples are not being obtained or where samples of acceptable quality are difficult to obtain, in situ vane shear tests may be utilized as a means of obtaining undrained shear strength. The apparatus and procedure for performing this test are described in ASTM D 2573. The results from this test may be greatly in error where shells or fibrous organic material are present. Also, test results in high plasticity clays must be corrected using empirical correction factors as given by Bjerrum (1972) (but these are not always conservative).

2-13. Groundwater and Pore Pressure Observations

Piezometers to observe groundwater fluctuations are rarely installed solely for design purposes but should always be installed in areas of potential underseepage problems. The use and installation of piezometers are described in EM 1110-2-1908. Permeability tests should always be made after installation of the

piezometers; these tests provide information on foundation permeability and show if piezometers are functioning. Testing and interpretation procedures are described in EM 1110-2-1908.

2-14. Field Pumping Tests

The permeability of pervious foundation materials can often be estimated with sufficient accuracy by using existing correlations with grain-size determination; see TM 5-818-5. However, field pumping tests are the most accurate means of determining permeabilities of stratified in situ deposits. Field pumping tests are expensive and usually justified only at sites of important structures and where extensive pressure relief well installations are planned. The general procedure is to install a well and piezometers at various distances from the well to monitor the resulting drawdown during pumping of the well. Appendix III of TM 5-818-5 gives procedures for performing field pumping tests.

Chapter 3 Laboratory Testing

3-1. General

a. Reference should be made to EM 1110-1-1906 for current soil testing procedures, and to EM 1110-2-1902 for applicability of the various shear strength tests in stability analyses.

b. Laboratory testing programs for levees will vary from minimal to extensive, depending on the nature and importance of the project and on the foundation conditions, how well they are known, and whether existing experience and correlations are applicable. Since shear and other tests to determine the engineering properties of soils are expensive and time-consuming, testing programs generally consist of water content and identification tests on most samples and shear, consolidation, and compaction tests only on representative samples of foundation and borrow materials. It is imperative to use all available data such as geological and geophysical studies, when selecting representative samples for testing. Soil tests that may be included in laboratory testing programs are listed in Table 3-1 for fine-grained cohesive soils and in Table 3-2 for pervious soils, together with pertinent remarks on purposes and scope of testing.

Table 3-1
Laboratory Testing of Fine-Grained Cohesive Soils

Test	Remarks
Visual classification and water content determinations	On all samples
Atterberg limits	On representative samples of foundation deposits for correlation with shear or consolidation parameters, and borrow soils for comparison with natural water contents, or correlations with optimum water content and maximum densities
Permeability	Not required; soils can be assumed to be essentially impervious in seepage analyses
Consolidation	Generally performed on undisturbed foundation samples only where: <ul style="list-style-type: none"> <i>a.</i> Foundation clays are highly compressible <i>b.</i> Foundations under high levees are somewhat compressible <i>c.</i> Settlement of structures within levee systems must be accurately estimated <p>Not generally performed on levee fill; instead use allowances for settlement within levees based on type of compaction. Sometimes satisfactory correlations of Atterberg limits with coefficient of consolidation can be used. Compression index can usually be estimated from water content.</p>
Compaction	<ul style="list-style-type: none"> <i>a.</i> Required only for compacted or semi-compacted levees <i>b.</i> Where embankment is to be fully compacted, perform standard 25-blow compaction tests <i>c.</i> Where embankment is to be semi-compacted, perform 15-blow compaction tests
Shear strength	<ul style="list-style-type: none"> <i>a.</i> Unconfined compression tests on saturated foundation clays without joints or slickensides <i>b.</i> Q triaxial tests appropriate for foundation clays, as undrained strength generally governs stability <i>c.</i> R triaxial and S direct shear: Generally required only when levees are high and/or foundations are weak, or at locations where structures exist in levees <i>d.</i> Q, R, and S tests on fill materials compacted at appropriate water contents to densities resulting from the expected field compaction effort

Table 3-2
Laboratory Testing of Pervious Materials

Test	Remarks
Visual classification	Of all jar samples
In situ density determinations	Of Shelby-tube samples of foundation sands where liquefaction susceptibility must be evaluated
Relative density	Maximum and minimum density tests should be performed in seismically active areas to determine in situ relative densities of foundation sands and to establish density control of sand fills
Gradation	On representative foundation sands: a. For correlating grain-size parameters with permeability or shear strength b. For size and distribution classifications pertinent to liquefaction potential
Permeability	Not usually performed. Correlations of grain-size parameters with permeability or shear strength used. Where underseepage problems are serious, best guidance obtained by field pumping tests
Consolidation	Not usually necessary as consolidation under load is insignificant and occurs rapidly
Shear strength	For loading conditions other than dynamic, drained shear strength is appropriate. Conservative values of ϕ' can be assumed based on S tests on similar soils. In seismically active areas, cyclic triaxial tests may be performed

3-2. Classification and Water Content Determinations

After soil samples have been obtained in subsurface exploration of levee foundations and borrow areas, the first and essential step is to make visual classifications and water content determinations on all samples (except that water content determinations should not be made on clean sands and gravels). These samples may be jar or bag samples obtained from test pits, disturbed or undisturbed drive samples, or auger samples. Field descriptions, laboratory classifications, and water content values are used in preparing graphic representations of boring logs. After examining these data, samples of fine-grained soils are selected for Atterberg limits tests, and samples of coarse-grained soils for gradation tests.

Section I

Fine-Grained Soils

3-3. Use of Correlations

Comparisons of Atterberg limits values with natural water contents of foundation soils and use of the plasticity chart itself (Figure 3-1), together with split-spoon driving resistance, geological studies, and previous experience often will indicate potentially weak and compressible fine-grained foundation strata and thus the need for shear and perhaps consolidation tests. In some cases, in the design of low levees on familiar foundation deposits for example, correlations between Atterberg limits values and consolidation or shear strength characteristics may be all that is necessary to evaluate these characteristics. Examples of correlations among Atterberg limits values, natural water content, shear strength and consolidation characteristics are shown in Figures 3-2 and 3-3. Correlations based on local soil types and which distinguish between normally and overconsolidated conditions are preferable. Such correlations may also be used to reduce the number of tests required for design of higher levees. As optimum water content may in some cases be correlated with Atterberg limits, comparisons of Atterberg limits and natural water contents of borrow soils as shown in Figure 3-4 can indicate whether the borrow materials are suitable for obtaining adequate compaction.

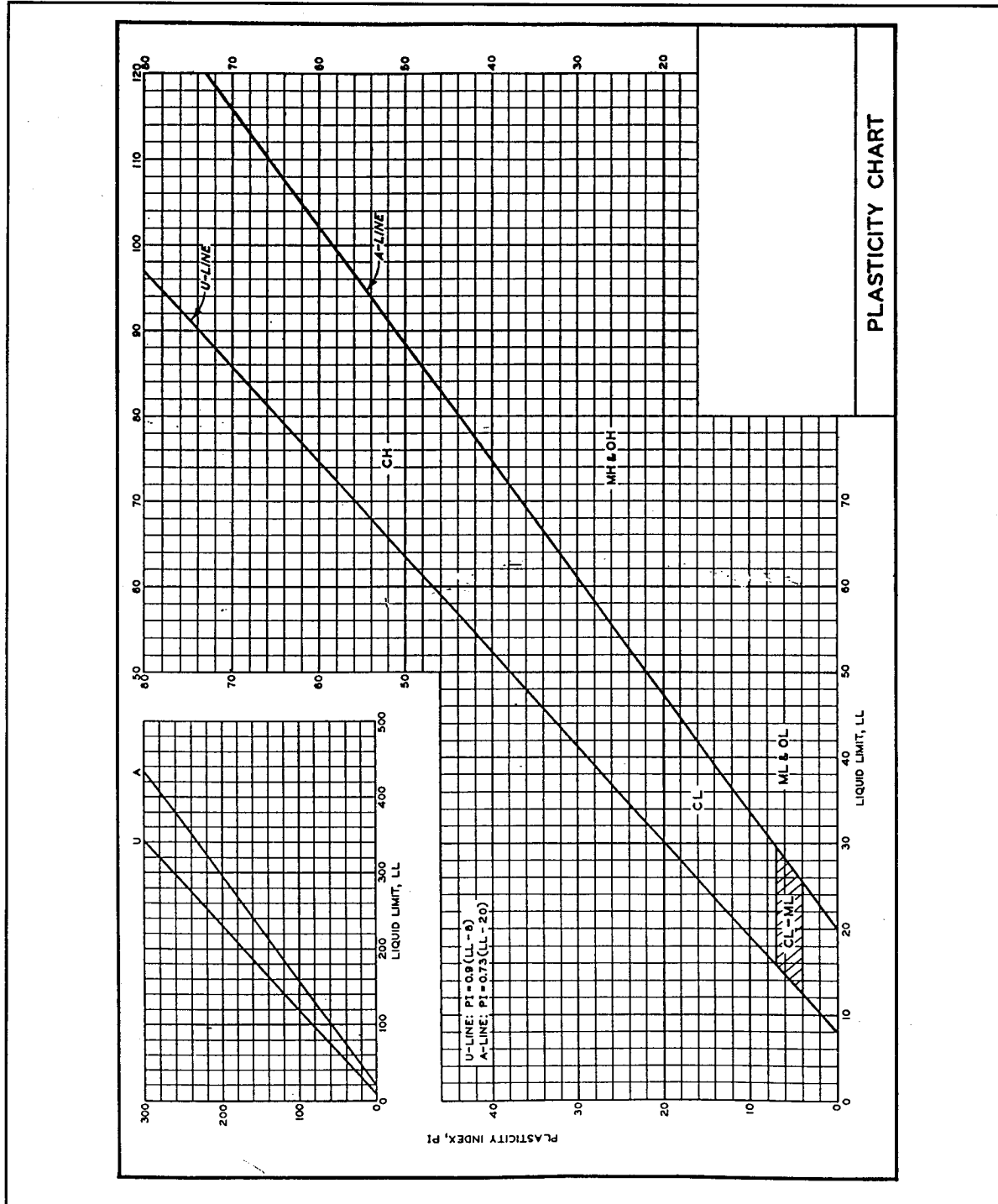

Figure 3-1. Plasticity chart (ENG Form 4334)

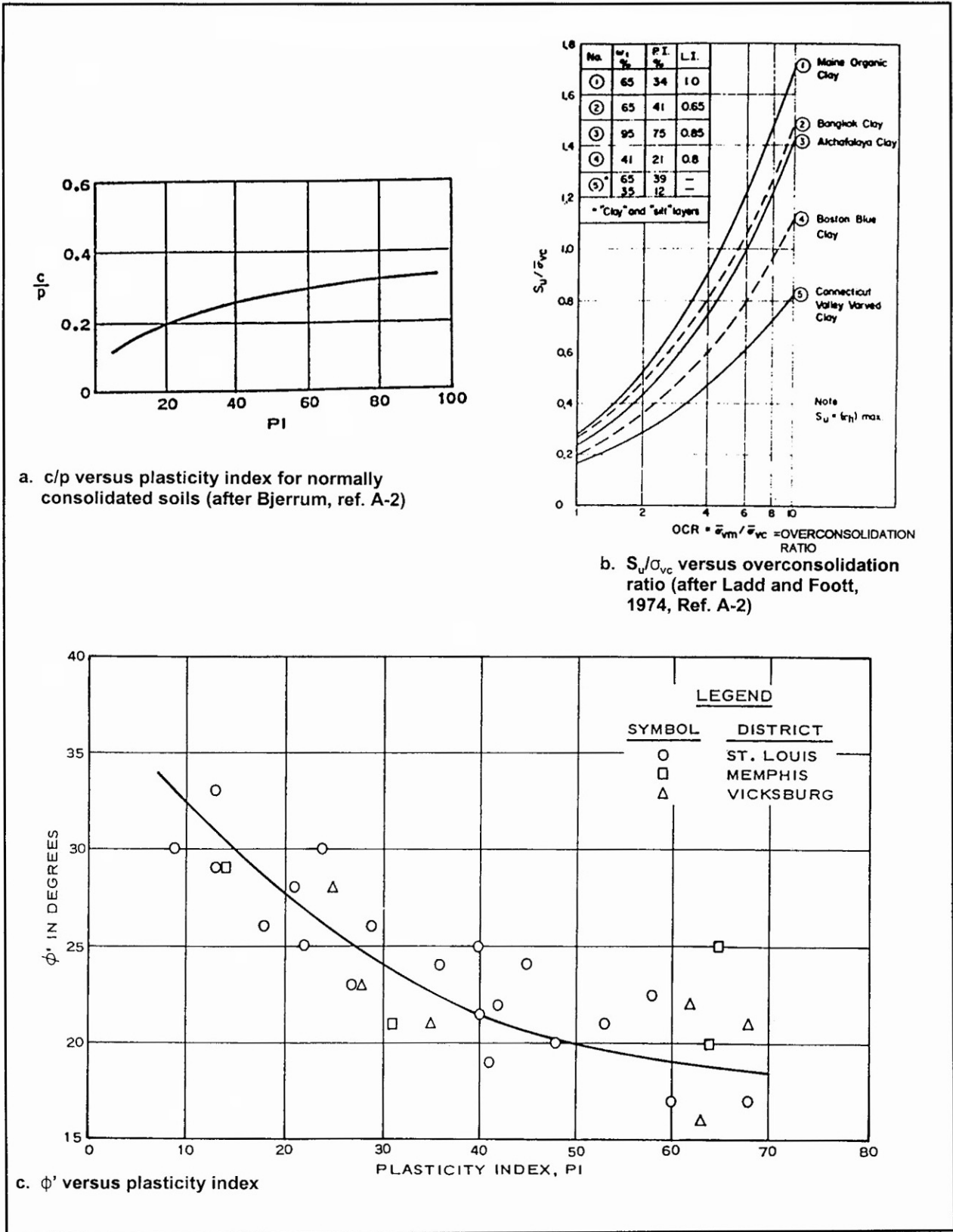
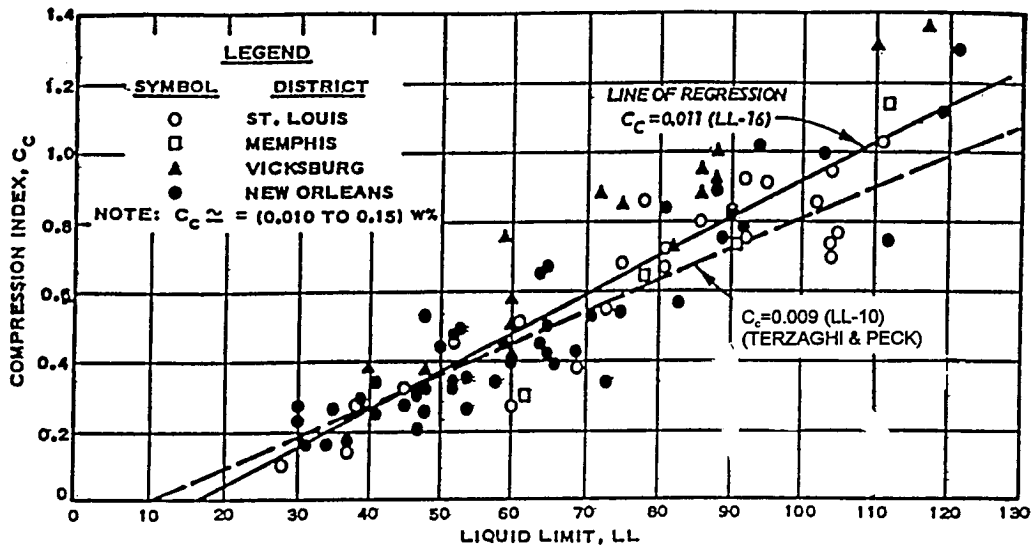
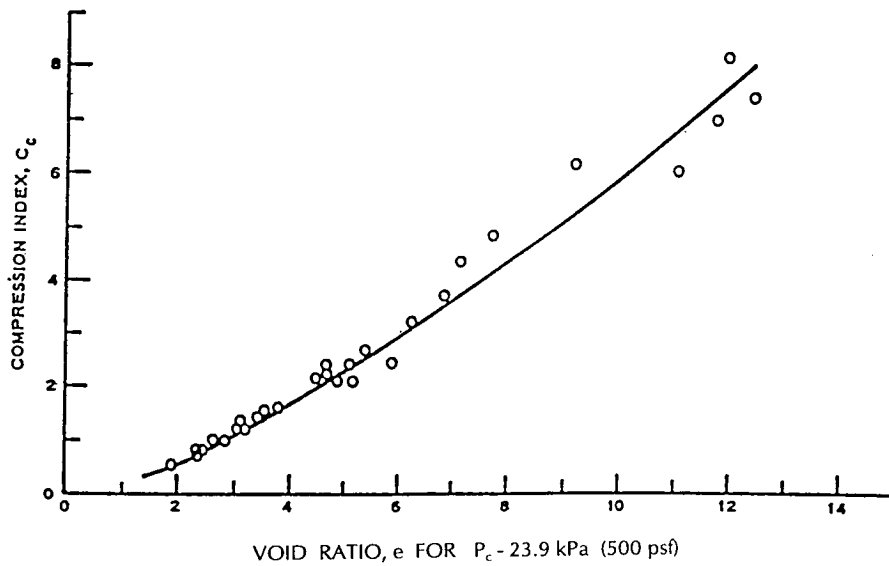

Figure 3-2. Example correlations of strength characteristics for fine-grained soils



a. Compression index versus liquid limit for normally consolidated soils



b. Compression index versus initial void ratio for tidal marsh

Figure 3-3. Example correlations for consolidation characteristics of fine-grained soils (after Kapp, ref. A-2)

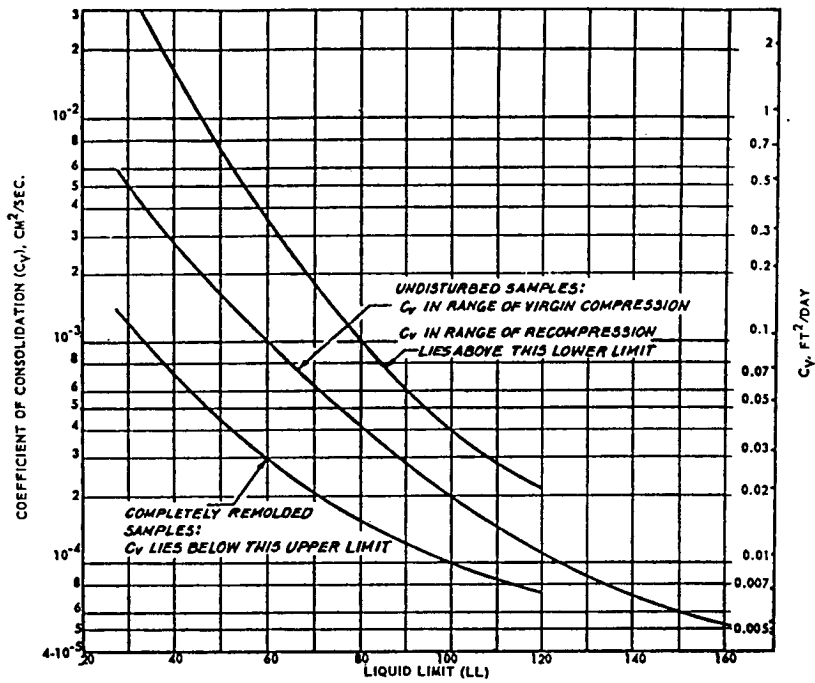

c. Coefficient of consolidation versus liquid limit (from NAVFAC DM-7 ref. A-1)

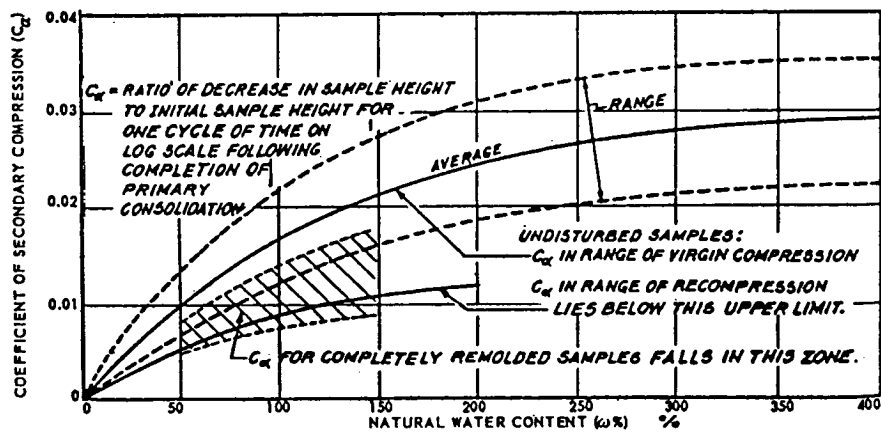

d. Coefficient of secondary compression versus water content (from NAVFAC DM-7 ref. A-1)

Figure 3-3. (Concluded)

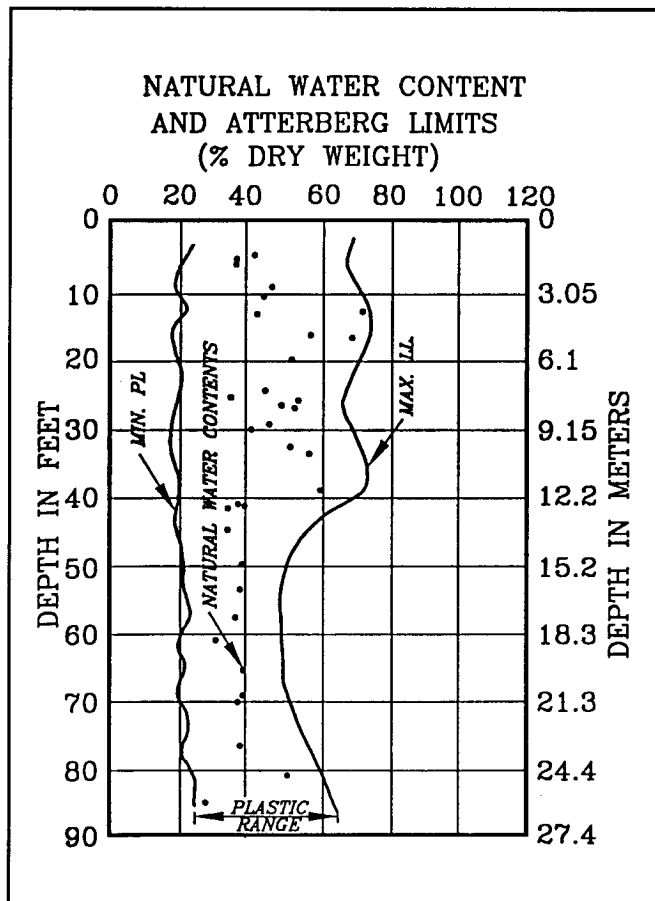

Figure 3-4. Comparisons of Atterberg limits and natural water contents

tions of liquid limit and natural water content with coefficient of consolidation, compression index, and coefficient of secondary compression can be used satisfactorily for making estimates of consolidation of foundation clays under load.

3-6. Permeability

Generally there is no need for laboratory permeability tests on fine-grained fill materials, nor on surface clays overlying pervious foundation deposits. In underseepage analyses, simplifying assumptions must be made relative to thickness and soil type of fine-grained surface blankets. Furthermore, animal burrows, root channels, and other discontinuities in surface blankets can significantly affect the overall effective permeability. Therefore, an average value of the coefficient of permeability based on the dominant soil type (Appendix B) is generally of sufficient accuracy for use in underseepage analyses, and laboratory tests are not essential.

3-7. Compaction Tests

The type and number of compaction tests will be influenced by the method of construction and the variability of available borrow materials. The types of compaction tests required are summarized in Table 3-1.

3-4. Shear Strength

Approximate shear strengths of fine-grained cohesive soils can be rapidly determined on undisturbed foundation samples, and occasionally on reasonably intact samples from disturbed drive sampling, using simple devices such as the pocket penetrometer, laboratory vane shear device, or the miniature vane shear device (Torvane). To establish the reliability of these tests, it is desirable to correlate them with unconfined compression tests. Unconfined compression tests are somewhat simpler to perform than Q triaxial compression tests, but test results exhibit more scatter. Unconfined compression tests are appropriate primarily for testing saturated clays which are not jointed or slickensided. Of the triaxial compression tests, the Q test is the one most commonly performed on foundation clays, since the in situ undrained shear strength generally controls embankment design on such soils. However, where embankments are high, stage construction is being considered, or important structures are located in a levee system, R triaxial compression tests and S direct shear tests should also be performed.

3-5. Consolidation

Consolidation tests are performed for those cases listed in Table 3-1. In some locations correlations

Section II
Coarse-Grained Soils

3-8. Shear Strength

When coarse-grained soils contain few fines, the consolidated drained shear strength is appropriate for use in all types of analyses. In most cases, conservative values of the angle of internal friction (ϕ) can be assumed from correlations such as those shown in Figure 3-5, and no shear tests will be needed.

3-9. Permeability

To solve the problem of underseepage in levee foundations, reasonable estimates of permeability of pervious foundation deposits are required. However, because of difficulty and expense in obtaining undisturbed samples of sands and gravels, laboratory permeability tests are rarely performed on foundation sands. Instead, field pumping tests or correlations such as that of Figure 3-5 developed between a grain-size parameter (such as D_{10}) and the coefficient of permeability, k , are generally utilized.

3-10. Density Testing of Pervious Fill

Maximum density tests on available pervious borrow materials should be performed in accordance with ASTM D 4253 so that relative compaction requirements for pervious fills may be checked in the field when required by the specification. Due to the inconsistencies in duplicating minimum densities (ASTM D 4254), relative density may not be used. Factors such as (but not limited to) site specific materials, availability of testing equipment and local practice may make it more practical to utilize methods other than ASTM D 4253 and ASTM D 4254 to control the degree of compaction of cohesionless material. The other methods used include comparison of in-place density to either the maximum Proctor density or the maximum density obtained by ASTM 4253 (if vibratory table is available).

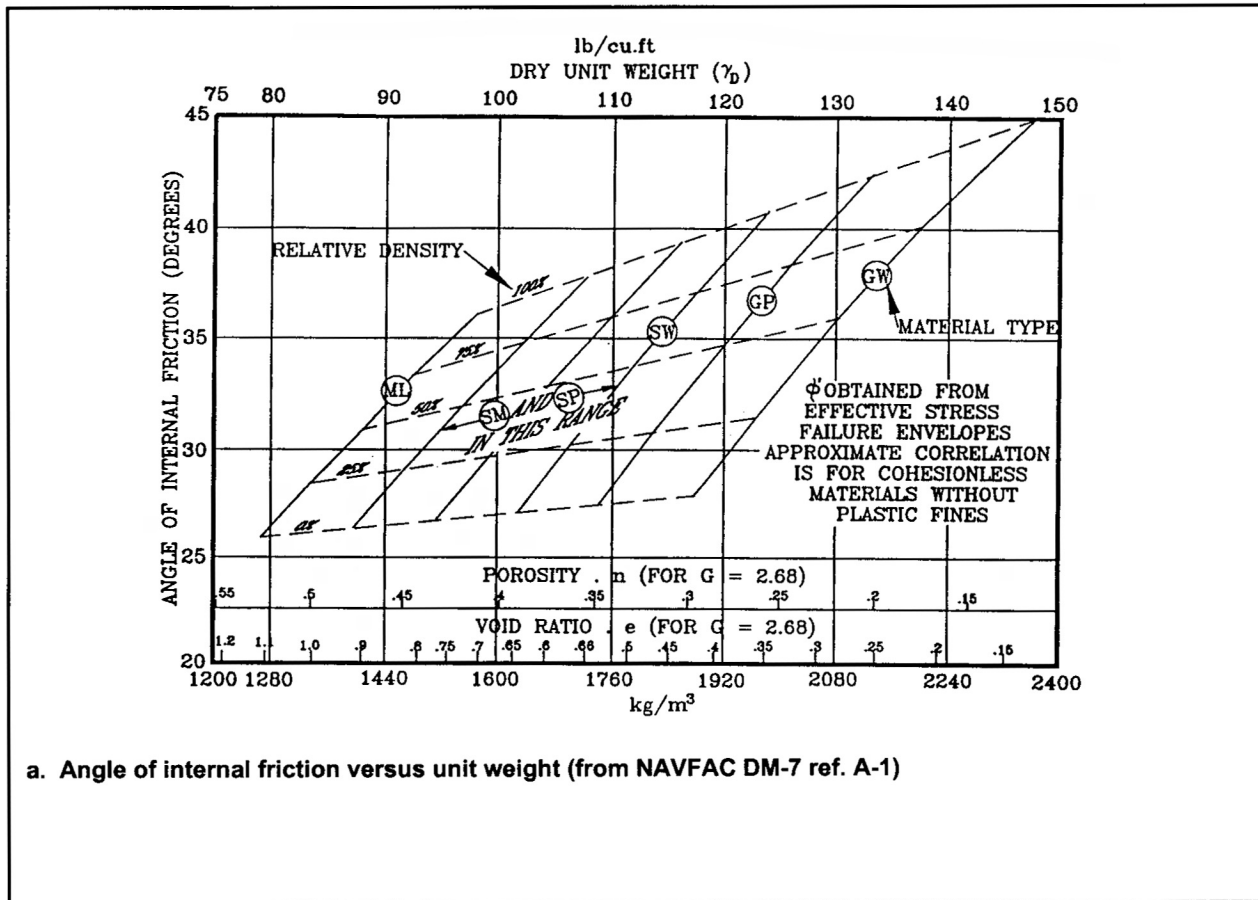

a. Angle of internal friction versus unit weight (from NAVFAC DM-7 ref. A-1)

Figure 3-5. Example correlations for properties of coarse-grained soils

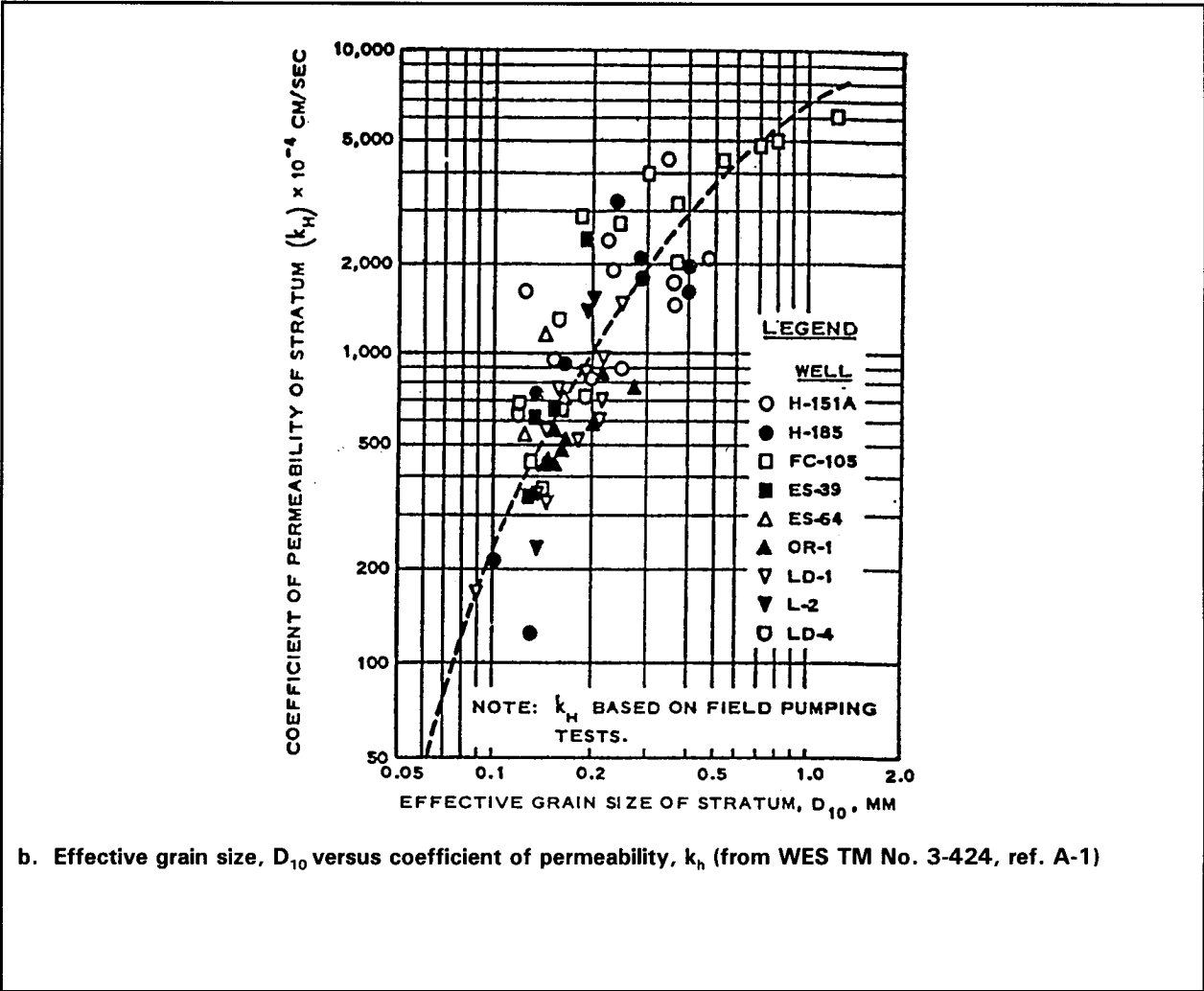

b. Effective grain size, D_{10} versus coefficient of permeability, k_h (from WES TM No. 3-424, ref. A-1)

Figure 3-5. (Concluded)

Chapter 4 Borrow Areas

4-1. General

In the past borrow areas were selected largely on the basis of material types and quantities and haul distances. Today, borrow areas receive much more attention and must be carefully planned and designed, because of considerations such as environmental aspects, increasing land values, and greater recognition of the effects of borrow areas with respect to underseepage, uplift pressures, overall levee stability, and erosion. The following paragraphs discuss some factors involved in locating and using borrow areas.

4-2. Available Borrow Material

a. Material type. Almost any soil is suitable for constructing levees, except very wet, fine-grained soils or highly organic soils. In some cases, though, even these soils may be considered for portions of levees. Accessibility and proximity are often controlling factors in selecting borrow areas, although the availability of better borrow materials involving somewhat longer haul distances may sometimes lead to the rejection of poorer but more readily available borrow.

b. Natural water content. Where compacted levees are planned, it is necessary to obtain borrow material with water content low enough to allow placement and adequate compaction. The cost of drying borrow material to suitable water contents can be very high, in many cases exceeding the cost of longer haul distances to obtain material that can be placed without drying. Borrow soils undergo seasonal water content variations; hence water content data should be based on samples obtained from borrow areas in that season of the year when levee construction is planned. Possible variation of water contents during the construction season should also be considered.

4-3. General Layout

Generally, the most economical borrow scheme is to establish pits parallel and adjacent to the levee. If a levee is adjacent to required channel excavation, levee construction can often utilize material from channel excavation. Large centralized borrow areas are normally established only for the construction of urban levees, where adjacent borrow areas are unavailable. Long, shallow borrow areas along the levee alignment are more suitable, not only because of the shorter haul distance involved, but also because they better satisfy environmental considerations.

a. Location. Where possible, borrow area locations on the river side of a levee are preferable as borrow pits. Borrow area locations within the protected area are less desirable environmentally, as well as generally being more expensive. Riverside borrow locations in some areas will be filled eventually by siltation, thereby obliterating the man-made changes in the landscape. While riverside borrow is generally preferable, required landside borrow from ponding areas, ditches, and other excavations should be used wherever possible. A berm should be left in place between the levee toe and the near edge of the borrow area. The berm width depends primarily on foundation conditions, levee height, and amount of land available. Its width should be established by seepage analyses where pervious foundation material is close to the bottom of the borrow pit and by stability analyses where the excavation slope is near the levee. Minimum berm widths used frequently in the past are 12.2 m (40 ft) riverside and 30.5 m (100 ft) landside, but berm widths should be the maximum practicable since borrow areas may increase the severity of underseepage effects. In borrow area excavation, an adequate thickness of impervious cover should be left over underlying

pervious material. For riverside pits a minimum of 0.91 m (3 ft) of cover should be left in place, and for landside pits the cover thickness should be adequate to prevent the formation of boils under expected hydraulic heads. Topsoil from borrow and levee foundation stripping can be stockpiled and spread over the excavated area after borrow excavation has been completed. This reinforces the impervious cover and provides a good base for vegetative growth.

b. Size and shape. It is generally preferable to have riverside borrow areas “wide and shallow” as opposed to “narrow and deep.” While this may require extra right-of-way and a longer haul distance, the benefits derived from improved underseepage, hydraulic, and environmental conditions usually outweigh the extra cost. In computing required fill quantities, a shrinkage factor of at least 25 percent should be applied (i.e., borrow area volumes should be at least 125 percent of the levee cross-section volume). This will allow for material shrinkage, and hauling and other losses. Right-of-way requirements should be established about 4.6 to 6.1 m (15 to 20 ft) beyond the top of the planned outer slope of the borrow pit. This extra right-of-way will allow for flattening or caving of the borrow slopes, and can provide maintenance borrow if needed later.

4-4. Design and Utilization

a. Slopes. Excavation slopes of borrow areas should be designed to assure stability. This is particularly important for slopes adjacent to the levee but could also be important for any slope whose top is near the right-of-way limits. Borrow area slopes must also be flat enough to allow mowing, if required. Also, where landside pits are to be placed back into cultivation, changes in grade must be gentle enough to allow farm equipment to operate safely. The slopes of the upstream and downstream ends of riverside pits should be flat enough to avoid erosion when subjected to flow at high water stages.

b. Depths. Depths to which borrow areas are excavated will depend upon factors such as (1) groundwater elevation, (2) changes at depth to undesirable material, (3) preservation of adequate thickness of riverside blanket, and (4) environmental considerations.

c. Foreshore. The foreshore is that area between the riverside edge of the borrow area and the riverbank as shown in Figure 4-1. If a foreshore is specified (i.e., the borrow excavation is not to be cut into the riverbank), it should have a substantial width, say 61 m (200 ft) or more, to help prevent migration of the river channel into the borrow area.

d. Traverse. A traverse is an unexcavated zone left in place at intervals across the borrow area (Figure 4-1). Traverses provide roadways across the borrow area, provide foundations for transmission towers and utility lines, prevent less than bank-full flows from coursing unchecked through the borrow area, and encourage material deposition in the borrow area during high water. Experience has shown that when traverses are overtopped or breached, severe scour damage can result unless proper measures are taken in their design. Traverse heights should be kept as low as possible above the bottom of the pit when they will be used primarily as haul roads. In all cases, flat downstream slopes (on the order of 1V and 6H to 10H) should be specified to minimize scour from overtopping. If the traverse carries a utility line or a public road, even flatter slopes and possibly stone protection should be considered.

e. Drainage. Riverside borrow areas should be so located and excavated that they will fill slowly on a rising river and drain fully on a falling river. This will minimize scour in the pit when overbank river stages occur, promote the growth of vegetation, and encourage silting where reclamation is possible. The bottom of riverside pits should be sloped to drain away from the levee. Culvert pipes should be provided through traverses, and foreshore areas should be ditched through to the river as needed for proper drainage. Landside pits should be sloped to drain away from or parallel to the levee with ditches provided as necessary to outlet

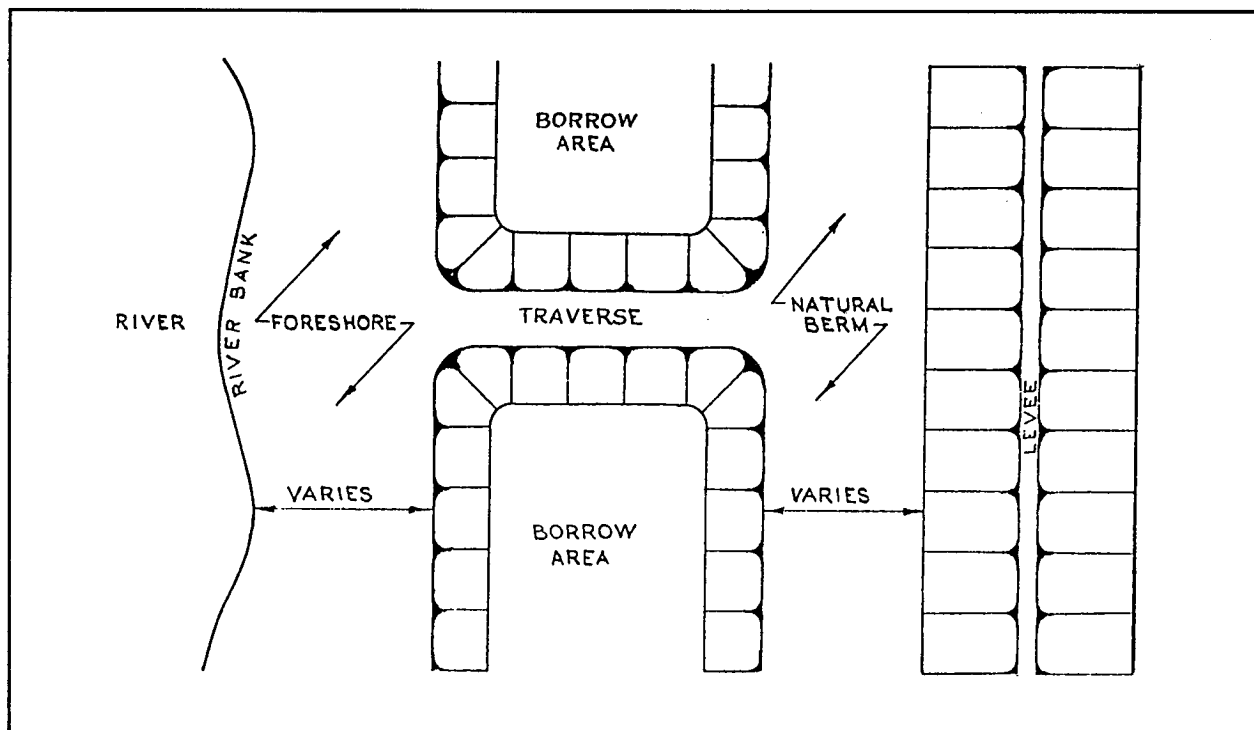

Figure 4-1. Plan of typical levee and borrow areas with traverse and foreshore

points. Gravity outlets or pump stations should be located so as to minimize lengths of flow paths within the pit area.

f. Flow conditions. To avoid damage from confined or restricted flow through the riverside borrow areas, obstructions or impediments to smooth and uniform flow should be removed if possible, or else protective measures must be taken. Riverside borrow areas should be made as uniform in width and grade as possible, avoiding abrupt changes. Removal of obstructions that could cause concentrated flow includes degradation of old levee remnants and of narrow high ground ridges beyond the borrow area, as well as removal of timber from traverses and from foreshore areas immediately adjacent to the borrow area. Obstructions to flow that cannot be removed include transmission towers, bridge piers, and other permanent structures near the levee. In such areas, stone protection should be provided for the levee or borrow area slopes if scour damage is considered probable.

g. Environmental aspects. The treatment of borrow areas after excavation to satisfy aesthetic and environmental considerations has become standard practice. The extent of treatment will vary according to the type and location of a project. Generally, projects near urban areas or where recreational areas are to be developed will require more elaborate treatment than those in sparsely populated agricultural areas. Minimum treatment should include proper drainage, topographic smoothing, and the promotion of conditions conducive to vegetative growth. Insofar as practicable, borrow areas should be planted to conform to the surrounding landscape. Stands of trees should be left remaining on landside borrow areas if at all possible, and excavation procedures should not leave holes, trenches, or abrupt slopes. Restoration of vegetative growth is important for both landside and riverside pits as it is not only pleasing aesthetically but serves as protection against erosion. Willow trees can aid considerably in drying out boggy areas. Riverside pits should not be excavated so deep that restored grass cover will be drowned out by long submergence.

Agencies responsible for maintenance of completed levees should be encouraged to plant and maintain vegetation, including timber, in the borrow areas. It is desirable that riverside borrow pits be filled in by natural processes, and frequent cultivation of these areas should be discouraged or prohibited, if possible, until this has been achieved. Guidelines for landscape planting are given in EM 1110-2-301.

h. Clearing, grubbing, and stripping. Borrow areas should be cleared and grubbed to the extent needed to obtain fill material free of objectionable matter, such as trees, brush, vegetation, stumps, and roots. Subareas within borrow areas may be specified to remain untouched to preserve standing trees and existing vegetation. Topsoil with low vegetative cover may be stripped and stockpiled for later placement on outer landside slopes of levees and seepage berms.

Chapter 5 Seepage Control

Section I *Foundation Underseepage*

5-1. General

Without control, underseepage in pervious foundations beneath levees may result in (a) excessive hydrostatic pressures beneath an impervious top stratum on the landside, (b) sand boils, and (c) piping beneath the levee itself. Underseepage problems are most acute where a pervious substratum underlies a levee and extends both landward and riverward of the levee and where a relatively thin top stratum exists on the landside of the levee. Principal seepage control measures for foundation underseepage are (a) cutoff trenches, (b) riverside impervious blankets, (c) landside seepage berms, (d) pervious toe trenches, and (e) pressure relief wells. These methods will be discussed generally in the following paragraphs. Detailed design guidance is given in Appendixes B and C. Turnbull and Mansur (1959) have proposed control measures for underseepage also. Additional information on seepage control in earth foundations including cutoffs, impervious blankets, seepage berms, relief wells and trench drains is given in EM 1110-2-1901 and EM 1110-2-1914.

5-2. Cutoffs

A cutoff beneath a levee to block seepage through pervious foundation strata is the most positive means of eliminating seepage problems. Positive cutoffs may consist of excavated trenches backfilled with compacted earth or slurry trenches usually located near the riverside toe. Since a cutoff must penetrate approximately 95 percent or more of the thickness of pervious strata to be effective, it is not economically feasible to construct cutoffs where pervious strata are of considerable thickness. For this reason cutoffs will rarely be economical where they must penetrate more than 12.2 m (40 ft). Steel sheet piling is not entirely watertight due to leakage at the interlocks but can significantly reduce the possibility of piping of sand strata in the foundation. Open trench excavations can be readily made above the water table, but if they must be made below the water table, well point systems will be required. Cutoffs made by the slurry trench method (reference Appendix A) can be made without a dewatering system, and the cost of this type of cutoff should be favorable in many cases in comparison with costs of compacted earth cutoffs.

5-3. Riverside Blankets

Levees are frequently situated on foundations having natural covers of relatively fine-grained impervious to semipervious soils overlying pervious sands and gravels. These surface strata constitute impervious or semipervious blankets when considered in connection with seepage control. If these blankets are continuous and extend riverward for a considerable distance, they can effectively reduce seepage flow and seepage pressures landside of the levee. Where underseepage is a problem, riverside borrow operations should be limited in depth to prevent breaching the impervious blanket. If there are limited areas where the blanket becomes thin or pinches out entirely, the blanket can be made effective by placing impervious materials in these areas. The effectiveness of the blanket depends on its thickness, length, distance to the levee riverside toe, and permeability and can be evaluated by flow-net or approximate mathematical solutions, as shown in Appendix B. Protection of the riverside blanket against erosion is important.

5-4. Landside Seepage Berms

a. *General.* If uplift pressures in pervious deposits underlying an impervious top stratum landward of a levee become greater than the effective weight of the top stratum, heaving and rupturing of the top stratum may occur, resulting in sand boils. The construction of landside berms (where space is available) can eliminate this hazard by providing (a) the additional weight needed to counteract these upward seepage forces and (b) the additional length required to reduce uplift pressures at the toe of the berm to tolerable values. Seepage berms may reinforce an existing impervious or semipervious top stratum, or, if none exists, be placed directly on pervious deposits. A berm also affords some protection against sloughing of the landside levee slope. Berms are relatively simple to construct and require very little maintenance. They frequently improve and reclaim land as areas requiring underseepage treatment are often low and wet. Berms can also serve as a source of borrow for emergency repairs to the levee. Because they require additional fill material and space, they are used primarily with agricultural levees. Subsurface profiles must be carefully studied in selecting berm widths. For example, where a levee is founded on a thin top stratum and thicker clay deposits lie a short distance landward, as shown in Figure 5-1, the berm should extend far enough landward to lap the thick clay deposit, regardless of the computed required length. Otherwise, a concentration of seepage and high exit gradients may occur between the berm toe and the landward edge of the thick clay deposit.

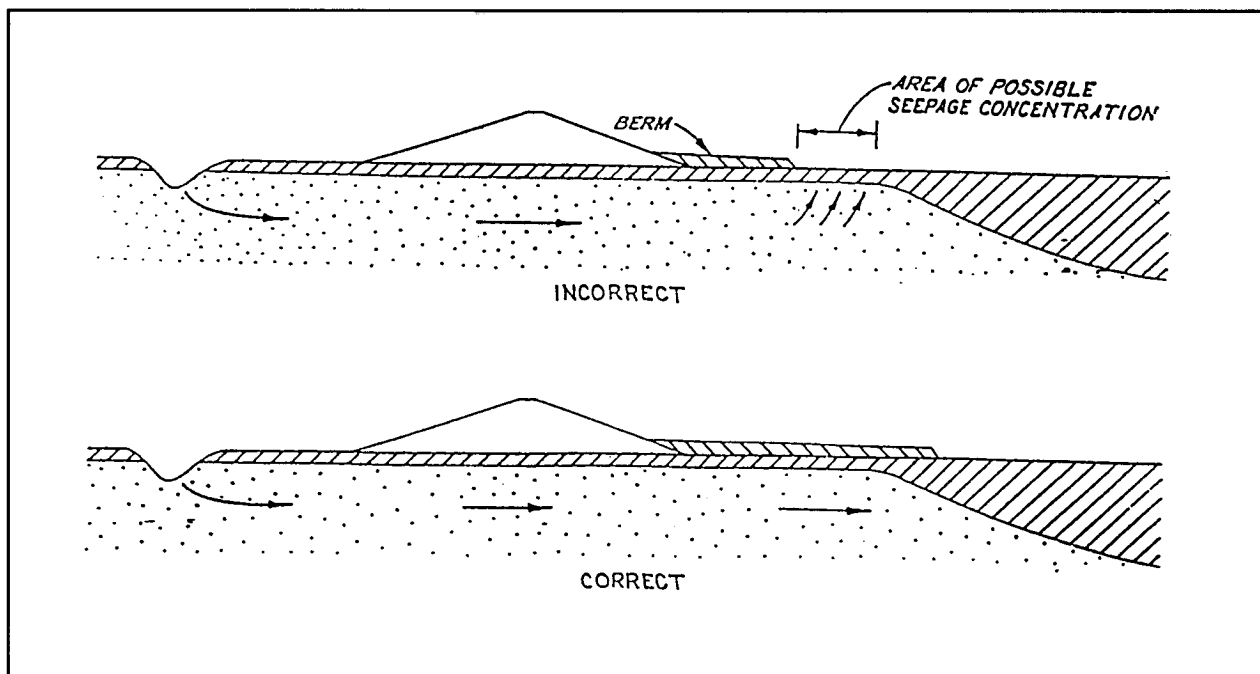

Figure 5-1. Example of incorrect and correct berm length according to existing foundation conditions

b. *Types of seepage berms.* Four types of seepage berms have been used, with selection based on available fill materials, space available landside of the levee proper, and relative costs.

(1) *Impervious berms.* A berm constructed of impervious soils restricts the pressure relief that would otherwise occur from seepage flow through the top stratum, and consequently increases uplift pressures

beneath the top stratum. However, the berm can be constructed to the thickness necessary to provide an adequate factor of safety against uplift.

(2) Semipervious berms. Semipervious material used in constructing this type of berm should have an in-place permeability equal to or greater than that of the top stratum. In this type of berm, some seepage will pass through the berm and emerge on its surface. However, since the presence of this berm creates additional resistance to flow, subsurface pressures at the levee toe will be increased.

(3) Sand berms. While a sand berm will offer less resistance to flow than a semipervious berm, it may also cause an increase in substratum pressures at the levee toe if it does not have the capacity to conduct seepage flow landward without excessive internal head losses. Material used in a sand berm should be as pervious as possible, with a minimum permeability of 100×10^{-4} cm per sec. Sand berms require less material and occupy less space than impervious or semipervious berms providing the same degree of protection.

(4) Free-draining berms. A free-draining berm is one composed of random fill overlying horizontal sand and gravel drainage layers (with a terminal perforated collector pipe system), designed by the same methods used for drainage layers in dams. Although the free-draining berm can afford protection against underseepage pressures with less length and thickness than the other types of seepage berms, its cost is generally much greater than the other types, and thus it is rarely specified.

c. Berm design. Design equations, criteria, and examples are presented in Appendix C for seepage berms.

d. Computer programs to use for seepage analysis.

(1) If the soil can be idealized with a top blanket of uniform thickness and seepage flow is assumed to be horizontal in the foundation and vertical in the blanket, then LEVSEEP (Brizendine, Taylor, and Gabr 1995) or LEVEEMSU (Wolff 1989; Gabr, Taylor, Brizendine, and Wolff 1995) could be used.

(2) If the soil profile is characterized by a top blanket and two foundation layers of uniform thickness, and seepage flow is assumed to be horizontal in the foundation, horizontal and vertical in the transition layer, and vertical in the blanket, then LEVEEMSU or the finite element method (CSEEP) could be used (Biedenharn and Tracy 1987; Knowles 1992; Tracy 1994; Gabr, Brizendine, and Taylor 1995). LEVEESMU would be simpler to use.

(3) If the idealized soil profile includes irregular geometry (slopes greater than 1 vertical to 100 horizontal), more than three layers and/or anisotropic permeability ($k_v \neq k_h$), then only the finite element method (CSEEP) is applicable. When using CSEEP it is recommended that FastSEEP, a graphical pre- and post-processor, be used for mesh generation, assigning boundary conditions and soil properties, and viewing the results (Engineering Computer Graphics Laboratory 1996).

5-5. Pervious Toe Trench

a. General. Where a levee is situated on deposits of pervious material overlain by little or no impervious material, a partially penetrating toe trench, as shown in Figure 5-2, can improve seepage conditions at or near the levee toe. Where the pervious stratum is thick, a drainage trench of any practicable depth would attract only a small portion of the seepage flow and detrimental underseepage would bypass the trench. Consequently, the main use of a pervious toe trench is to control shallow underseepage and protect the area in the vicinity of the levee toe. Pervious toe trenches may be used in conjunction with relief well systems;

the wells collect the deeper seepage and the trench collects the shallow seepage. Such a system is shown in Figure 5-3. The trench is frequently provided with a perforated pipe to collect the seepage. The use of a collector system is dependent on the volume of seepage and, to some degree, the general location of the levee. Collector systems are usually not required for agricultural levees but find wider use in connection with urban levees.

b. Location. As seen in Figures 5-2 and 5-3, pervious drainage trenches are generally located at the levee toe, but are sometimes constructed beneath the downstream levee slope as shown in Figure 5-4. Here the trench is located at the landward quarter point of the levee, and discharge is provided through a horizontal pervious drainage layer. Unless it is deep enough, it may allow excessive seepage pressures to act at the toe. There is some advantage to a location under the levee if the trench serves also as an inspection trench and because the horizontal pervious drainage layer can help to control embankment seepage.

c. Geometry. Trench geometry will depend on the volume of expected underseepage, desired reduction in uplift pressure, construction practicalities, and the stability of the material in which it is being excavated. Trench widths varying from 0.61 to 1.83 m (2 to 6 ft) have been used. Trench excavation can be expedited if a ditching machine can be used. However, narrow trench widths will require special compaction equipment. One such piece of equipment (Figure 5-5), which is a vibrating-plate type of compactor specially made to fit on the boom of a backhoe, has apparently performed satisfactorily.

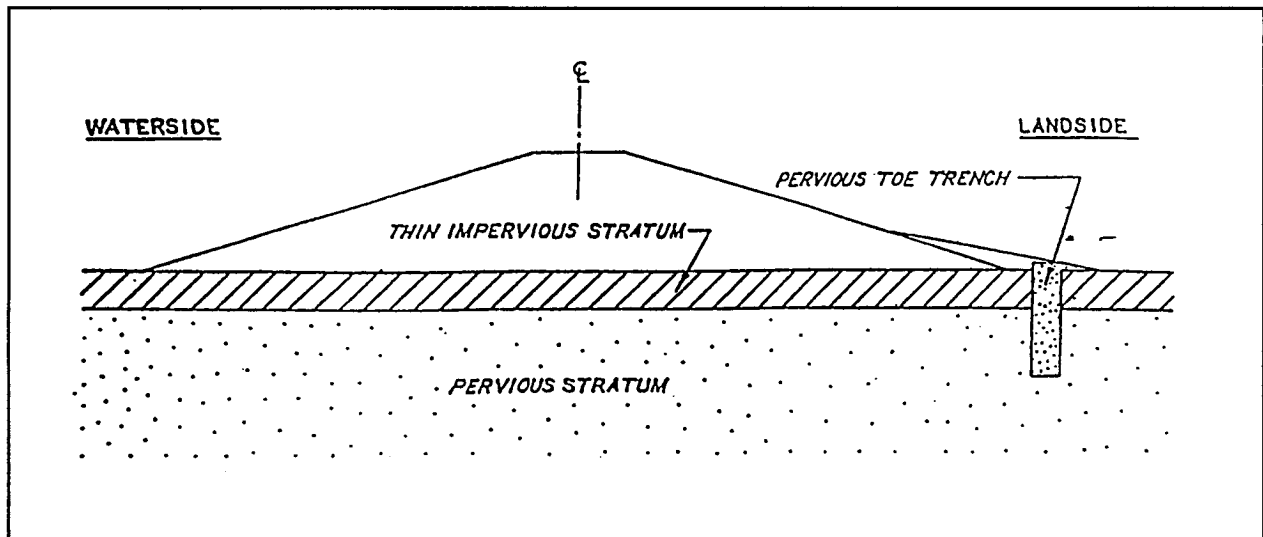

Figure 5-2. Typical partially penetrating pervious toe trench

d. Backfill. The sand backfill for trenches must be designed as a filter material in accordance with criteria given in Appendix D. If a collector pipe is used, the pipe should be surrounded by about a 305-mm (1-ft) thickness of gravel having a gradation designed to provide a stable transition between the sand backfill and the perforations or slots in the pipe. A typical section of a pervious drainage trench with collector pipe is shown in Figure 5-6. Placement of trench backfill must be done in such a manner as to minimize segregation. Compaction of the backfill should be limited to prevent breakdown of material or over compaction resulting in lowered permeabilities.

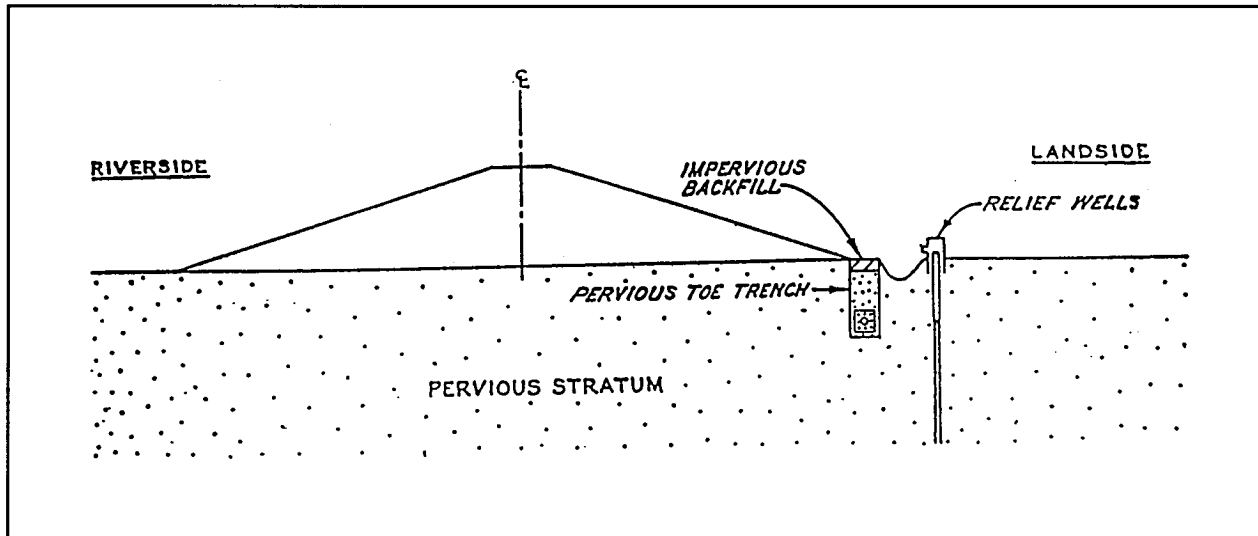

Figure 5-3. Typical pervious toe trench with collector pipe (Figure 5-6 shows trench details)

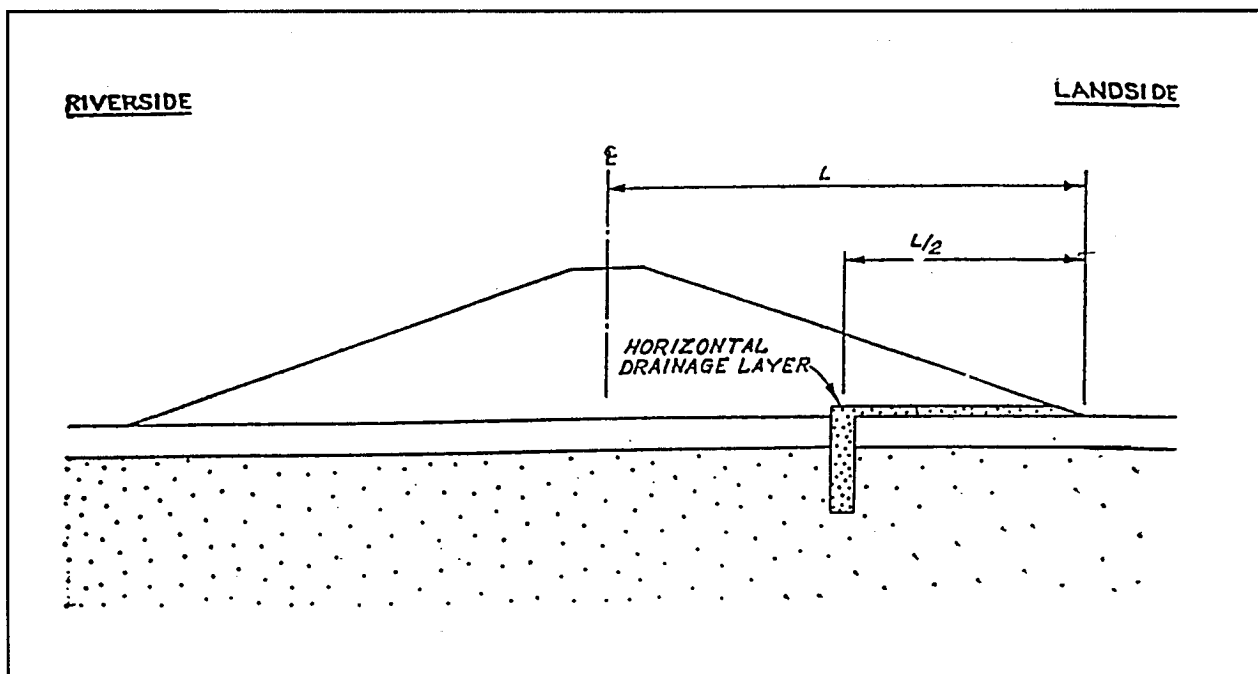

Figure 5-4. Pervious toe trench located beneath landward slope

5-6. Pressure Relief Wells

a. General. Pressure relief wells may be installed along the landside toe of levees to reduce uplift pressure which may otherwise cause sand boils and piping of foundation materials. Wells accomplish this by intercepting and providing controlled outlets for seepage that would otherwise emerge uncontrolled landward of the levee. Pressure relief well systems are used where pervious strata underlying a levee are



Figure 5-5. Special equipment for compacting sand in pervious toe trenches

ward from the well line should not exceed 0.50 (equivalent to $FS = 1.7$ for an average soil saturated unit weight of 1840 kg/m^3 (115 pcf)). Many combinations of well spacing and penetration will produce the desired pressure relief; hence, the final selected spacing and penetration must be based on cost comparisons of alternative combinations. After the general well spacing for a given reach of levee has been determined, the actual location of each well should be established to ensure that the wells will be located at critical seepage points and will fit natural topographic features.

too deep or too thick to be penetrated by cutoffs or toe drains or where space for landside berms is limited. Relief wells should adequately penetrate pervious strata and be spaced sufficiently close to intercept enough seepage to reduce to safe values the hydrostatic pressures acting beyond and between the wells. The wells must offer little resistance to the discharge of water while at the same time prevent loss of any soil. They must also be capable of resisting corrosion and bacterial clogging. Relief well systems can be easily expanded if the initial installation does not provide the control needed. Also, the discharge of existing wells can be increased by pumping if the need arises. A relief well system requires a minimum of additional real estate as compared with the other seepage control measures such as berms. However, wells require periodic maintenance and frequently suffer loss in efficiency with time, probably due to clogging of well screens by muddy surface waters, bacteria growth, or carbonate incrustation. They increase seepage discharge, and means for collecting and disposing of their discharge must be provided.

b. Design of well systems. The design of a pressure relief well system involves determination of well spacing, size, and penetration to reduce uplift between wells to allowable values. Factors to be considered are (a) depth, stratification, and permeability of foundation soils, (b) distance to the effective source of seepage, (c) characteristics of the landside top stratum, if any, and (d) degree of pressure relief desired. Guidance on the method used to determine well spacing, size, and penetration is contained in EM 1110-2-1914 and U.S. Army Engineer Waterways Experiment Station TM No. 3-424. Where no control measures are present, relief wells for agricultural and urban levees should be designed so that i_{max} midway between the wells or land-

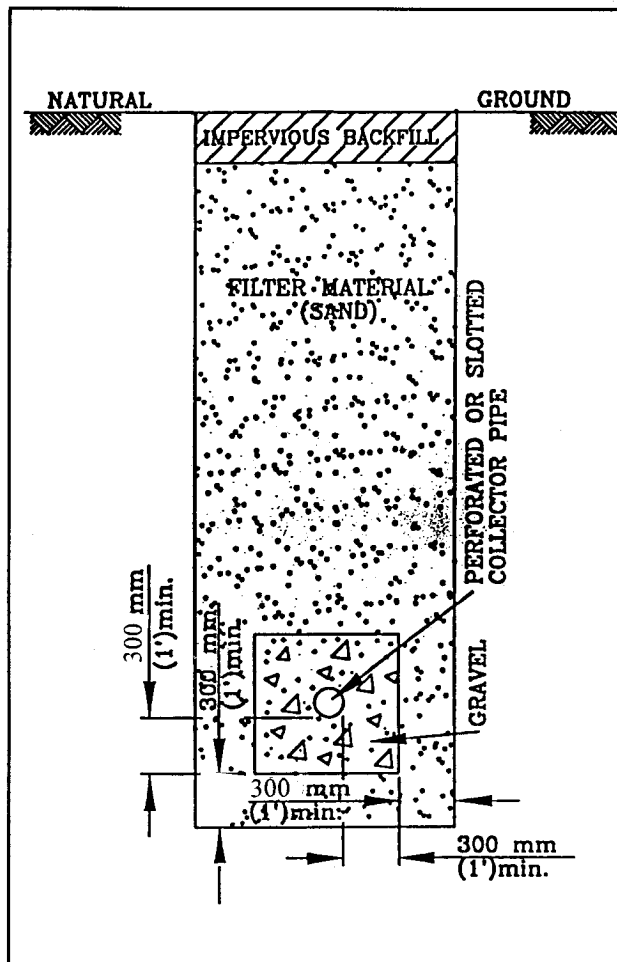

Figure 5-6. Pervious toe trench with collector pipe

and 1.2 m (4 ft) below the bottom of the well screen. Above the filter to the bottom of the concrete or impervious backfill, sand backfill may be used.

(3) Well appurtenances. In selecting well appurtenances, consideration must be given to ease of maintenance, protection against contamination from back flooding, damage by debris, and vandalism. To prevent wells from becoming backflooded with muddy surface water, which greatly impairs their efficiency when they are not flowing, an aluminum check valve, rubber gasket, and plastic standpipe, as shown in Figure 5-7, can be installed on each well. To safeguard against vandalism, accidental damage, and the entrance of debris, the tops of the wells should be provided with a metal screen or flap-type gate. The elevation of the top of any protective standpipes must be used in design as the well discharge elevation.

d. Well installation. Proper methods of drilling, backfilling, and developing a relief well must be employed or the well will be of little or no use. These procedures are described in detail in EM 1110-2-1914.

c. Design of individual wells. The design of the well involves the selection of type and length of riser pipe and screen, design of the gravel pack, and design of well appurtenances. A widely used well design that has given good service in the past is shown in Figure 5-7.

(1) Riser pipe and screen. The well screen normally extends from just below the top of the pervious stratum to the bottom of the well, with solid riser pipe installed from the top of the pervious strata to the surface. In zones of very fine sand or silt, the screen is replaced by unperforated (blank) pipe. The type of material for the riser and screen should be selected only after a careful study of the corrosive properties of the water to be carried by the well. Many types of metals, alloys, fiberglass, plastics, and wood have been used in the past. At the present time, stainless steel and plastic are the most widely used, primarily because of their corrosion-resistant properties. Plastic risers should be considered with caution, being susceptible to damages during mechanical treatment or chemical treatment which develop excessive heat or cold.

(2) Filter. The filter that surrounds the screen must be designed in accordance with criteria given in Appendix D using the slot size of the screen and the gradation of surrounding pervious deposit as a basis of design. No matter what size screen is used, a minimum of 152.4 mm (6 in.) of filter material should surround the screen and the filter should extend a minimum of 610.8 mm (2 ft) above the top

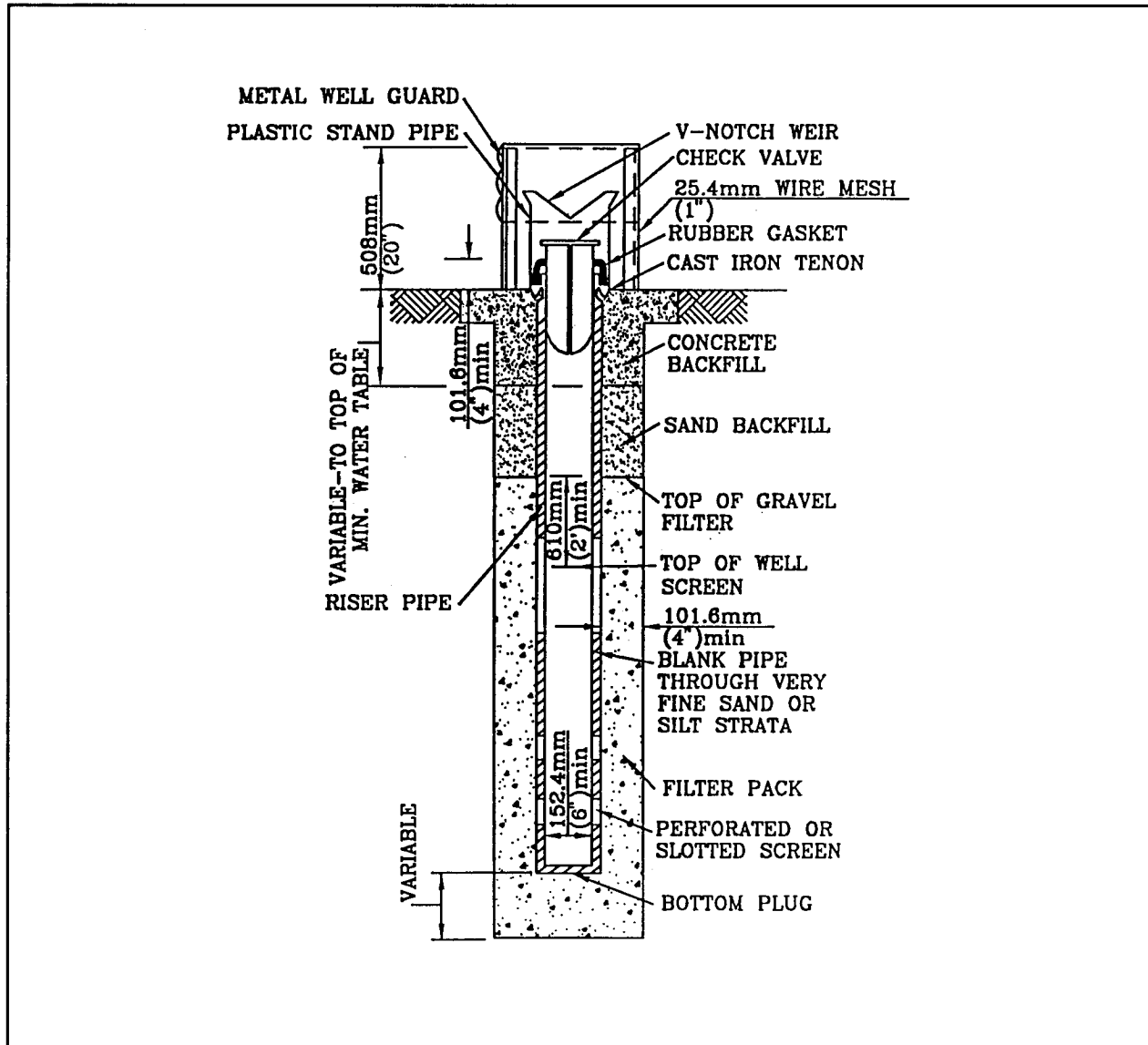

Figure 5-7. Typical relief well

Section II
Seepage Through Embankments

5-7. General

Should through seepage in an embankment emerge on the landside slope (Figure 5-8a), it can soften fine-grained fill in the vicinity of the landside toe, cause sloughing of the slope, or even lead to piping (internal erosion) of fine sand or silt materials. Seepage exiting on the landside slope would also result in high seepage forces, decreasing the stability of the slope. In many cases, high water stages do not act against the levee long enough for this to happen, but the possibility of a combination of high water and a period of heavy precipitation may bring this about. If landside stability berms or berms to control underseepage are required because of foundation conditions, they may be all that is necessary to prevent seepage emergence on the

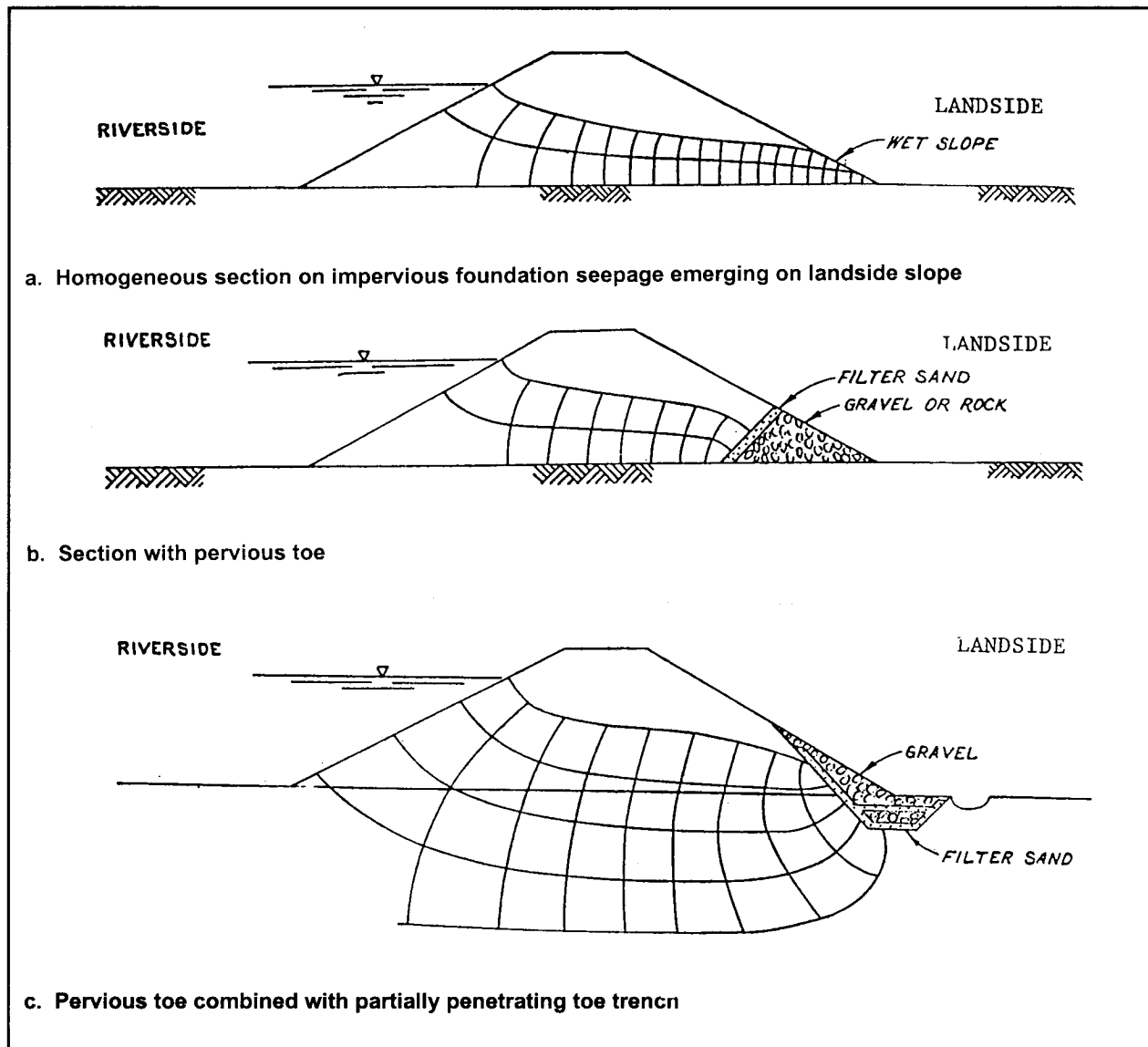

Figure 5-8. Embankment with through seepage

slope. On the other hand, if no berms are needed, landside slopes are steep, and floodstage durations and other pertinent considerations indicate a potential problem of seepage emergence on the slope, provisions should be incorporated in the levee section such as horizontal and/or inclined drainage layers or toe drains to prevent seepage from emerging on the landside slope. These require select pervious granular material and graded filter layers to ensure continued functioning, and therefore add an appreciable cost to the levee construction, unless suitable materials are available in the borrow areas with only minimal processing required. Where large quantities of pervious materials are available in the borrow areas, it may be more practicable to design a zoned embankment with a large landside pervious zone. This would provide an efficient means of through seepage control and good utilization of available materials. Additional information on seepage control in earth embankments including zoning embankments and vertical (or inclined) and horizontal drains is given in Chapter 8 of EM 1110-2-1901.

5-8. Pervious Toe Drain

A pervious toe (Figure 5-8b) will provide a ready exit for seepage through the embankment and can lower the phreatic surface sufficiently so that no seepage will emerge on the landside slope. A pervious toe can also be combined with partially penetrating toe trenches, which have previously been discussed, as a method for controlling shallow underseepage. Such a configuration is shown in Figure 5-8c.

5-9. Horizontal Drainage Layers

Horizontal drainage layers, as shown in Figure 5-9a, essentially serve the same purpose as a pervious toe but are advantageous in that they can extend further under the embankment requiring a relatively small amount of additional material. They can also serve to protect the base of the embankment against high uplift pressures where shallow foundation underseepage is occurring. Sometimes horizontal drainage layers serve also to carry off seepage from shallow foundation drainage trenches some distance under the embankment as shown previously in Figure 5-4.

5-10. Inclined Drainage Layers

An inclined drainage layer as shown in Figure 5-9b is one of the more positive means of controlling internal seepage and is used extensively in earth dams. It is rarely used in levee construction because of the added cost, but might be justified for short levee reaches in important locations where landside slopes must be steep and other control measures are not considered adequate and the levee will have high water against it for prolonged periods. The effect of an inclined drainage layer is to completely intercept embankment seepage regardless of the degree of stratification in the embankment or the material type riverward or landward of the drain. As a matter of fact, the use of this type of drain allows the landside portion of a levee to be built of any material of adequate strength regardless of permeability. When used between an impervious core and outer pervious shell (Figure 5-9c), it also serves as a filter to prevent migration of impervious fines into the outer shell. If the difference in gradation between the impervious and pervious material is great, the drain may have to be designed as a graded filter (Appendix D). Inclined drains must be tied into horizontal drainage layers to provide an exit for the collected seepage as shown in Figures 5-9b and 5-9c.

5-11. Design of Drainage Layers

The design of pervious toe drains and horizontal and inclined drainage layers must ensure that such drains have adequate thickness and permeability to transmit seepage without any appreciable head loss while at the same time preventing migration of finer soil particles. The design of drainage layers must satisfy the criteria outlined in Appendix D for filter design. Horizontal drainage layers should have a minimum thickness of 457.2 mm (18 in.) for construction purposes.

5-12. Compaction of Drainage Layers

Placement and compaction of drainage layers must ensure that adequate density is attained, but should not allow segregation and contamination to occur. Vibratory rollers are probably the best type of equipment for compaction of cohesionless material although crawler tractors and rubber-tired rollers have also been used successfully. Saturation or flooding of the material as the roller passes over it will aid in the compaction process and in some cases has been the only way specified densities could be attained. Care must always be taken to not overcompact to prevent breakdown of materials or lowering of expected permeabilities. Loading, dumping, and spreading operations should be observed to ensure that segregation does not occur. Gradation tests should be run both before and after compaction to ensure that the material meets specifications and does not contain too many fines.

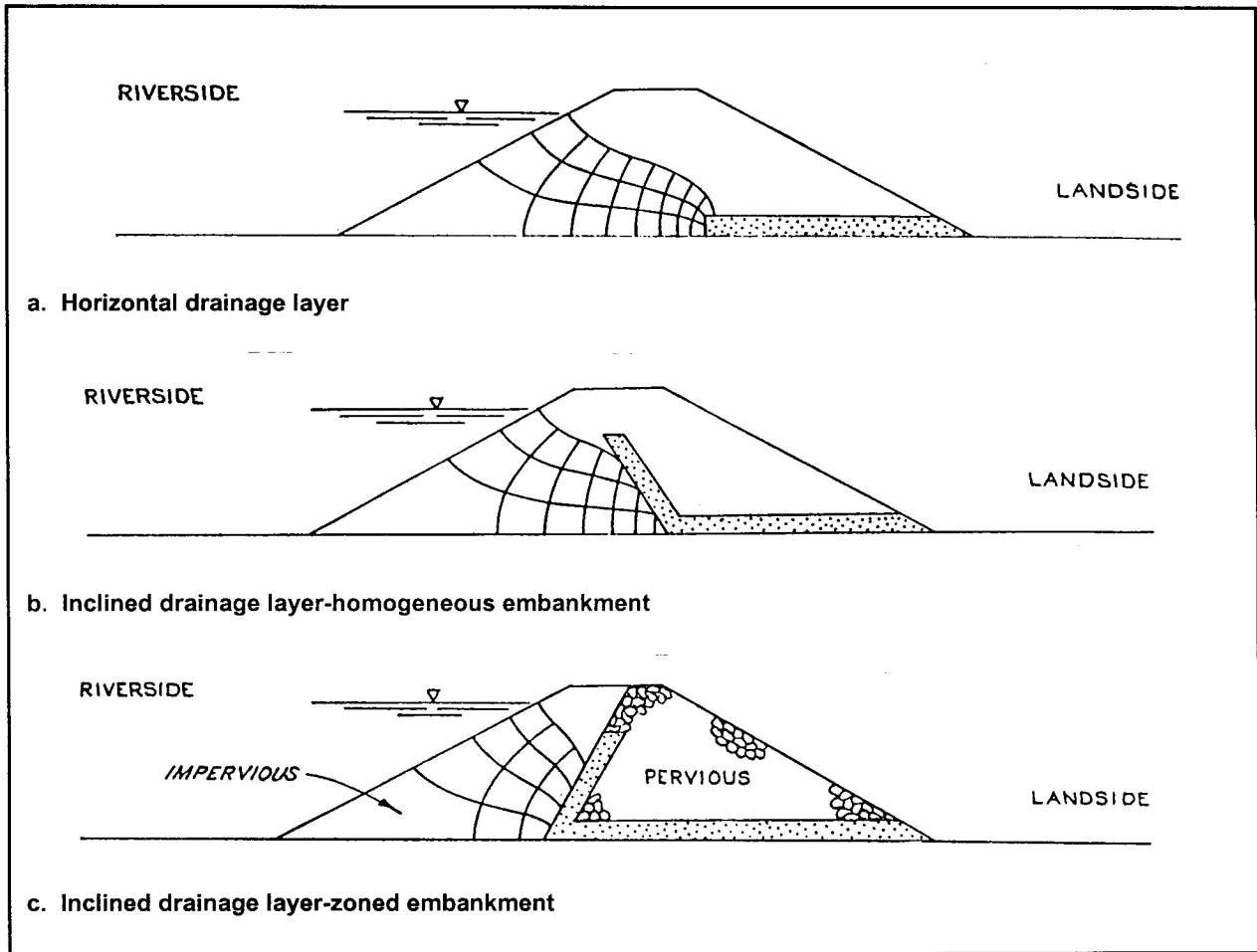

Figure 5-9. Use of horizontal and inclined drainage layers to control seepage through an embankment

Chapter 6 Slope Design and Settlement

Section I *Embankment Stability*

6-1. Embankment Geometry

a. Slopes. For levees of significant height or when there is concern about the adequacy of available embankment materials or foundation conditions, embankment design requires detailed analysis. Low levees and levees to be built of good material resting on proven foundations may not require extensive stability analysis. For these cases, practical considerations such as type and ease of construction, maintenance, seepage and slope protection criteria control the selection of levee slopes.

(1) Type of construction. Fully compacted levees generally enable the use of steeper slopes than those of levees constructed by semicompacted or hydraulic means. In fact, space limitations in urban areas often dictate minimum levee sections requiring select material and proper compaction to obtain a stable section.

(2) Ease of construction. A 1V on 2H slope is generally accepted as the steepest slope that can easily be constructed and ensure stability of any riprap layers.

(3) Maintenance. A 1V on 3H slope is the steepest slope that can be conveniently traversed with conventional mowing equipment and walked on during inspections.

(4) Seepage. For sand levees, a 1V on 5H landside slope is considered flat enough to prevent damage from seepage exiting on the landside slope.

(5) Slope protection. Riverside slopes flatter than those required for stability may have to be specified to provide protection from damage by wave action.

b. Final Levee Grade. In the past, freeboard was used to account for hydraulic, geotechnical, construction, operation and maintenance uncertainties. The term and concept of freeboard to account for these uncertainties is no longer used in the design of levee projects. The risk-based analysis directly accounts for hydraulic uncertainties and establishes a nominal top of protection. Deterministic analysis using physical properties of the foundation and embankment materials should be used to set the final levee grade to account for settlement, shrinkage, cracking, geologic subsidence, and construction tolerances.

c. Crown width. The width of the levee crown depends primarily on roadway requirements and future emergency needs. To provide access for normal maintenance operations and floodfighting operations, minimum widths of 3.05 to 3.66 m (10 to 12 ft) are commonly used with wider turnaround areas provided at specified intervals; these widths are about the minimum feasible for construction using modern heavy earthmoving equipment and should always be used for safety concerns. Where the levee crown is to be used as a higher class road, its width is usually established by the responsible agency.

6-2. Standard Levee Sections and Minimum Levee Section

a. Many districts have established standard levee-sections for particular levee systems, which have proven satisfactory over the years for the general stream regime, foundation conditions prevailing in those areas, and for soils available for levee construction. For a given levee system, several different standard

sections may be established depending on the type of construction to be used (compacted, semicompacted, uncompacted, or hydraulic fill). The use of standard sections is generally limited to levees of moderate height (say less than 7.62 m (25 ft)) in reaches where there are no serious underseepage problems, weak foundation soils, or undesirable borrow materials (very wet or very organic). In many cases the standard levee section has more than the minimum allowable factor of safety relative to slope stability, its slopes being established primarily on the basis of construction and maintenance considerations. Where high levees or levees on foundations presenting special underseepage or stability problems are to be built, the uppermost riverside and landside slopes of the levee are often the same as those of the standard section, with the lower slopes flattened or stability berms provided as needed.

b. The adoption of standard levee sections does not imply that stability and underseepage analyses are not made. However, when borings for a new levee clearly demonstrate foundation and borrow conditions similar to those at existing levees, such analyses may be very simple and made only to the extent necessary to demonstrate unquestioned levee stability. In addition to being used in levee design, the standard levee sections are applicable to initial cost estimate, emergency and maintenance repairs.

c. The minimum levee section shall have a crown width of at least 3.05 m (10 ft) and a side slope flatter than or equal to 1V on 2H, regardless of the levee height or the possibly less requirements indicated in the results of stability and seepage analyses. The required dimensions of the minimum levee section is to provide an access road for flood-fighting, maintenance, inspection and for general safety conditions.

6-3. Effects of Fill Characteristics and Compaction

a. *Compacted fills.* The types of compaction, water content control, and fill materials govern the steepness of levee slopes from the stability aspect if foundations have adequate strength. Where foundations are weak and compressible, high quality fill construction is not justified, since these foundations can support only levees with flat slopes. In such cases uncompacted or semicompacted fill, as defined in paragraph 1-5, is appropriate. Semicompacted fill is also used where fine-grained borrow soils are considerably wet of optimum or in construction of very low levees where other considerations dictate flatter levee slopes than needed for stability. Uncompacted fill is generally used where the only available borrow is very wet and frequently has high organic content and where rainfall is very high during the construction season. When foundations have adequate strength and where space is limited in urban areas both with respect to quantity of borrow and levee geometry, compacted levee fill construction by earth dam procedures is frequently selected. This involves the use of select material, water content control, and compaction procedures as described in paragraph 1-5.

b. *Hydraulic Fill.* Hydraulic fill consists mostly of pervious sands built with one or two end-discharge or bottom-discharging pipes. Tracked or rubber-tired dozers or front-end loaders are used to move the sand to shape the embankment slopes. Because a levee constructed of hydraulic fill would be very pervious and have a low density, it would require a large levee footprint and would be susceptible to soil liquefaction. Hydraulic fill would also quickly erode upon overtopping or where an impervious covering was penetrated. For these reasons, hydraulic fill may be used for stability berms, pit fills and seepage berms but shall not normally be used in constructing levee embankments. However, hydraulic fill may be used for levees protecting agricultural areas whose failure would not endanger human life and for zoned embankments that include impervious seepage barriers.

Section II
Stability Analyses

6-4. Methods of Analysis

The principal methods used to analyze levee embankments for stability against shear failure assume either (a) a sliding surface having the shape of a circular arc within the foundation and/or the embankment or (b) a composite failure surface composed of a long horizontal plane in a relatively weak foundation or thin foundation stratum connecting with diagonal plane surfaces up through the foundation and embankment to the ground surface. Various methods of analysis are described in EM 1110-2-1902, and can be chosen for use where determined appropriate by the designer. Computer programs are available for these analyses, with the various loading cases described in EM 1110-2-1902, so the effort of making such analyses is greatly reduced, and primary attention can be devoted to the more important problems of defining the shear strengths, unit weights, geometry, and limits of possible sliding surfaces.

6-5. Conditions Requiring Analysis

The various loading conditions to which a levee and its foundation may be subjected and which should be considered in analyses are designated as follows: Case I, end of construction; Case II, sudden drawdown from full flood stage; Case III, steady seepage from full flood stage, fully developed phreatic surface; Case IV, earthquake. Each case is discussed briefly in the following paragraphs and the applicable type of design shear strength is given. For more detailed information on applicable shear strengths, methods of analysis, and assumptions made for each case refer to EM 1110-2-1902.

a. Case I - End of construction. This case represents undrained conditions for impervious embankment and foundation soils; i.e., excess pore water pressure is present because the soil has not had time to drain since being loaded. Results from laboratory Q (unconsolidated-undrained) tests are applicable to fine-grained soils loaded under this condition while results of S (consolidated-drained) tests can be used for pervious soils that drain fast enough during loading so that no excess pore water pressure is present at the end of construction. The end of construction condition is applicable to both the riverside and landside slopes.

b. Case II - Sudden drawdown. This case represents the condition whereby a prolonged flood stage saturates at least the major part of the upstream embankment portion and then falls faster than the soil can drain. This causes the development of excess pore water pressure which may result in the upstream slope becoming unstable. For the selection of the shear strengths see Table 6-1a.

c. Case III - Steady seepage from full flood stage (fully developed phreatic surface). This condition occurs when the water remains at or near full flood stage long enough so that the embankment becomes fully saturated and a condition of steady seepage occurs. This condition may be critical for landside slope stability. Design shear strengths should be based on Table 6-1a.

d. Case IV - Earthquake. Earthquake loadings are not normally considered in analyzing the stability of levees because of the low probability of earthquake coinciding with periods of high water. Levees constructed of loose cohesionless materials or founded on loose cohesionless materials are particularly susceptible to failure due to liquefaction during earthquakes. Depending on the severity of the expected earthquake and the importance of the levee, seismic analyses to determine liquefaction susceptibility may be required.

Table 6-1a
Summary of Design Conditions

Analysis Condition	Shear Strength ^a	Pore Water Pressure
During and End-of-Construction	Free draining soils - use effective stresses	Free draining soils - Pore water pressures can be estimated using analytical techniques such as hydrostatic pressure computations for no flow or steady seepage analysis techniques (flow nets, finite element analyses or finite difference analyses).
	Low permeability soils - use undrained strengths and total stresses ^b	Low permeability soils - Total stresses are used; pore water pressures are set to zero in the slope stability computations.
Steady State Seepage Conditions	Use effective stresses. Residual strengths should be used where previous shear deformation or sliding has occurred.	Estimated from field measurements of pore water pressures, hydrostatic pressure computations for no flow conditions, or steady seepage analysis techniques (flow nets, finite element analyses or finite difference analyses).
Sudden Drawdown Conditions	Free draining soils - use effective stresses	Free draining soils - First stage computations (before drawdown) - steady-state seepage pore pressures as described for steady state seepage condition. Second and third stage computations (after drawdown) - pore water pressures estimated using same techniques as for steady seepage, except with lowered water levels.
	Low permeability soils - Three stage computations: First stage use effective stresses; second stage use undrained shear strengths and total stresses; third stage use drained strengths (effective stresses) or undrained strengths (total stresses) depending on which strength is lower - this will vary along the assumed shear surface.	Low permeability soils - First stage computations - steady-state seepage pore pressures as described for steady state seepage condition. Second stage computations - Total stresses are used pore water pressures are set to zero. Third stage computations - Use same pore pressures as free draining soils if drained strengths are being used; where undrained strengths are used pore water pressures are set to zero.

^a Effective stress parameters can be obtained from consolidated-drained (CD, S) tests (either direct shear or triaxial) or consolidated-undrained (CU, R) triaxial tests on saturated specimens with pore water pressure measurements. Direct shear or Bromhead ring shear tests should be used to measure residual strengths. Undrained strengths can be obtained from unconsolidated-undrained (UU, Q) tests. Undrained shear strengths can also be estimated using consolidated-undrained (CU, R) tests on specimens consolidated to appropriate stress conditions representative of field conditions; however, the "R" or "total stress" envelope and associated c and $\bar{\sigma}$, from CU, R tests should not be used.

^b For saturated soils use $\bar{\sigma} = 0$; total stress envelope with $\bar{\sigma} > 0$ is only applicable to partially saturated soils.

6-6. Minimum Acceptable Factors of Safety

The minimum required safety factors for the preceding design conditions along with the portion of the embankment for which analyses are required and applicable shear test data are shown in Table 6-1b.

6-7. Measures to Increase Stability

Means for improving weak and compressible foundations to enable stable embankments to be constructed thereon are discussed in Chapter 7. Methods of improving embankment stability by changes in embankment section are presented in the following paragraphs.

a. Flatten embankment slopes. Flattening embankment slopes will usually increase the stability of an embankment against a shallow foundation type failure that takes place entirely within the embankment. Flattening embankment slopes reduces gravity forces tending to cause failure, and increases the length of potential failure surfaces (and therefore increases resistance to sliding).

Table 6-1b
Minimum Factors of Safety - Levee Slope Stability

Type of Slope	Applicable Stability Conditions and Required Factors of Safety			
	End-of-Construction	Long-Term (Steady Seepage)	Rapid Drawdown ^a	Earthquake ^b
New Levees	1.3	1.4	1.0 to 1.2	(see below)
Existing Levees	--	1.4 ^c	1.0 to 1.2	(see below)
Other Embankments and dikes ^d	1.3 ^{e,f}	1.4 ^{c,f}	1.0 to 1.2 ^f	(see below)

^a Sudden drawdown analyses. F. S. = 1.0 applies to pool levels prior to drawdown for conditions where these water levels are unlikely to persist for long periods preceding drawdown. F. S. = 1.2 applies to pool level, likely to persist for long periods prior to drawdown.

^b See ER 1110-2-1806 for guidance. An EM for seismic stability analysis is under preparation.

^c For existing slopes where either sliding or large deformation have occurred previously and back analyses have been performed to establish design shear strengths lower factors of safety may be used. In such cases probabilistic analyses may be useful in supporting the use of lower factors of safety for design.

^d Includes slopes which are part of cofferdams, retention dikes, stockpiles, navigation channels, breakwater, river banks, and excavation slopes.

^e Temporary excavated slopes are sometimes designed for only short-term stability with the knowledge that long-term stability is not adequate. In such cases higher factors of safety may be required for end-of-construction to ensure stability during the time the excavation is to remain open. Special care is required in design of temporary slopes, which do not have adequate stability for the long-term (steady seepage) condition.

^f Lower factors of safety may be appropriate when the consequences of failure in terms of safety, environmental damage and economic losses are small.

b. Stability berms. Berms essentially provide the same effect as flattening embankment slopes but are generally more effective because of concentrating additional weight where it is needed most and by forcing a substantial increase in the failure path. Thus, berms can be an effective means of stabilization not only for shallow foundation and embankment type failures but for more deep-seated foundation failures as well. Berm thickness and width should be determined from stability analyses and the length should be great enough to encompass the entire problem area, the extent of which is determined from the soil profile. Foundation failures are normally preceded by lateral displacement of material beneath the embankment toe and by noticeable heave of material just beyond the toe. When such a condition is noticed, berms are often used as an emergency measure to stabilize the embankment and prevent further movement.

6-8. Surface Slides

Experience indicates that shallow slides may occur in levee slopes after heavy rainfall. Failure generally occurs in very plastic clay slopes. They are probably the result of shrinkage during dry weather and moisture gain during wet weather with a resulting loss in shear strength due to a net increase in water content, plus additional driving force from water in cracks. These failures require maintenance and could be eliminated or reduced in frequency by using less plastic soils near the surface of the slopes or by chemical stabilization of the surface soils.

Section III
Settlement

6-9. General

Evaluation of the amount of postconstruction settlement that can occur from consolidation of both embankment and foundation may be important if the settlement would result in loss of freeboard of the levee or damage to structures in the embankment. Many districts overbuild a levee by a given percent of its height to take into account anticipated settlement both of the foundation and within the levee fill itself. Common allowances are 0 to 5 percent for compacted fill, 5 to 10 percent for semicompacted fill, 15 percent for uncompacted fill, and 5 to 10 percent for hydraulic fill. Overbuilding does however increase the severity of stability problems and may be impracticable or undesirable for some foundations.

6-10. Settlement Analyses

Settlement estimates can be made by theoretical analysis as set forth in EM 1110-1-1904. Detailed settlement analyses should be made when significant consolidation is expected, as under high embankment loads, embankments of highly compressible soil, embankments on compressible foundations, and beneath steel and concrete structures in levee systems founded on compressible soils. Where foundation and embankment soils are pervious or semipervious, most of the settlement will occur during construction. For impervious soils it is usually conservatively assumed that all the calculated settlement of a levee built by a normal sequence of construction operations will occur after construction. Where analyses indicate that more foundation settlement would occur than can be tolerated, partial or complete removal of compressible foundation material may be necessary from both stability and settlement viewpoints. When the depth of excavation required to accomplish this is too great for economical construction, other methods of control such as stage construction or vertical sand drains may have to be employed, although they seldom are justified for this purpose.

Chapter 7 Levee Construction

Section I Levee Construction Methods

7-1. Classification of Methods

a. Levee embankments classified according to construction methods used are listed in Table 7-1 for levees composed of impervious and semipervious materials (i.e., those materials whose compaction characteristics are such as to produce a well-defined maximum density at a specific optimum water content). While the central portion of the embankment may be Category I (compacted) or II (semicompacted), riverside and landside berms (for seepage or stability purposes) may be constructed by Category II or III (uncompacted) methods.

b. Pervious levee fill consisting of sands or sands and gravels may be placed either in the dry with normal earthmoving equipment or by hydraulic fill methods. Except in seismically active areas or other areas requiring a high degree of compaction, compaction by vibratory means other than that afforded by tracked bulldozers is not generally necessary. Where underwater placement is required, it can best be accomplished with pervious fill using end-dumping, dragline, or hydraulic means, although fine-grained fill can be so placed if due consideration is given to the low density and strength obtained using such materials.

Section II Foundations

7-2. Foundation Preparation and Treatment

a. General. Minimum foundation preparation for levees consists of clearing and grubbing, and most levees will also require some degree of stripping. Clearing, grubbing, stripping, the disposal of products therefrom, and final preparation are discussed in the following paragraphs.

b. Clearing. Clearing consists of complete removal of all objectional and/or obstructive matter above the ground surface. This includes all trees, fallen timber, brush, vegetation, loose stone, abandoned structures, fencing, and similar debris. The entire foundation area under the levee and berms should be cleared well ahead of any following construction operations.

c. Grubbing. Grubbing consists of the removal, within the levee foundation area, of all stumps, roots, buried logs, old piling, old paving, drains, and other objectional matter. Grubbing is usually not necessary beneath stability berms. Roots or other intrusions over 38.1 mm (1-1/2 in.) in diameter within the levee foundation area should be removed to a depth of 0.91 m (3 ft) below natural ground surface. Shallow tile drains sometimes found in agricultural areas should be removed from the levee foundation area. The sides of all holes and depressions caused by grubbing operations should be flattened before backfilling. Backfill, consisting of material similar to adjoining soils, should be placed in layers up to the final foundation grade and compacted to a density equal to the adjoining undisturbed material. This will avoid "soft spots" under the levee and maintain the continuity of the natural blanket.

d. Stripping. After foundation clearing and grubbing operations are complete, stripping is commenced. The purpose of stripping is to remove low growing vegetation and organic topsoil. The depth of stripping

**Table 7-1
Classification According to Construction Method of Levees Composed of Impervious and Semipervious Materials**

Category	Construction Method	Use
I. Compacted	<p>Specification of:</p> <ul style="list-style-type: none"> a. Water content range with respect to standard effort optimum water content b. Loose lift thickness (152.4 mm to 228.6 mm (6-9 in.)) c. Compaction equipment (sheepsfoot or rubber-tired rollers) d. Number of passes to attain a given percent compaction based on standard maximum density e. Minimum required density 	<p>Provides embankment section occupying minimum space. Provides strong embankments of low compressibility needed adjacent to concrete structures or forming parts of highway systems.</p> <p>Requires strong foundation of low compressibility and availability of borrow materials with natural water contents reasonably close to specified ranges.</p> <p>Used where field inspection is not constant throughout the project.</p>
II. Semicompacted	<p>Compaction of fill materials at their natural water content (i.e., no water content control). Borrow materials known to be too wet would require some drying before placement. Placed in thicker lifts than Category I (about 304.8 mm (12 in.)) and compacted either by controlled movement of hauling and spreading equipment or by fewer passes of sheepsfoot or rubber-tired rollers. Compaction evaluated relative to 15-blow compaction test.</p>	<p>The most common type of levee construction used in reaches where:</p> <ul style="list-style-type: none"> a. There are no severe space limitations and steep-sloped Category I embankments are not required. b. Relatively weak foundations could not support steep-sloped Category I embankments. c. Underseepage conditions are such as to require wider embankment base than is provided by Category I construction. d. Water content of borrow materials or amount of rainfall during construction season is such as not to justify Category I compaction.
III. Uncompacted	<ul style="list-style-type: none"> a. Fill cast or dumped in place in thick layers with little or no spreading or compaction. b. Hydraulic fill by dredge, often from channel excavation. 	<p>Levees infrequently constructed today using methods except for temporary emergency. Both methods are used for construction of stability berms, pit fills and seepage berms.</p>

is determined by local conditions and normally varies from 152.4 to 304.8 mm (6 to 12 in.) Stripping is usually limited to the foundation of the levee embankment proper, not being required under berms. All stripped material suitable for use as topsoil should be stockpiled for later use on the slopes of the embankment and berms. Unsuitable material must be disposed of by methods described in the next paragraph.

e. Disposal of debris. Debris from clearing, grubbing, and stripping operations can be disposed of by burning in areas where this is permitted. When burning is prohibited by local regulations, it needs to be disposed of in an environmentally approved manner.

f. Exploration trench. An exploration trench (often termed “inspection trench”) should be excavated under all levees unless special conditions as discussed later warrant its omission. The purpose of this trench is to expose or intercept any undesirable underground features such as old drain tile, water or sewer lines, animal burrows, buried logs, pockets of unsuitable material, or other debris. The trench should be located at or near the centerline of hauled fill levees or at or near the riverside toe of sand levees so as to connect with waterside impervious facings. Dimensions of the trench will vary with soil conditions and embankment configurations. Backfill should be placed only after a careful inspection of the excavated trench to ensure that seepage channels or undesirable material are not present; if they are, they should be dug out with a base of sufficient width to allow backfill compaction with regular compaction equipment. To backfill narrower trenches properly, special compaction procedures and/or equipment will be required. Trenches should have a minimum depth of 1.83 m (6 ft) except for embankment heights less than 1.83 m (6 ft), in which case the minimum depth should equal the embankment height. Exploration trenches can be omitted where landside toe drains beneath the levee proper constructed to comparable depths are employed (toe drains are discussed in more detail later in this chapter).

g. Dewatering. Dewatering levee foundations for the purpose of excavation and back filling in the dry is expensive if more than simple ditches and sumps are required, and is usually avoided if at all possible. The cost factor may be an overriding consideration in choosing seepage control measures other than a compacted cutoff trench, such as berms, blankets, or relief wells. Where a compacted cutoff trench involving excavation below the water table must be provided, dewatering is essential. TM 5-818-5 provides guidance in dewatering system design.

h. Final foundation preparation. Soft or organic spots in the levee foundation should be removed and replaced with compacted material. Except in special cases where foundation surfaces are adversely affected by remolding (soft foundations for instance), the foundation surface upon or against which fill is to be placed should be thoroughly broken up to a depth of at least 152.4 mm (6 in.) prior to the placement of the first lift of fill. This helps to ensure good bond between the foundation and fill and to eliminate a plane of weakness at the interface. The foundation surface should be kept drained and not scarified until just prior to fill placement in order to avoid saturation from rainfall.

7-3. Methods of Improving Stability

a. General. Levees located on foundation soils that cannot support the levee embankment because of inadequate shear strength require some type of foundation treatment if the levee is to be built. Foundation deposits that are prone to cause problems are broadly classified as follows: (1) very soft clays, (2) sensitive clays, (3) loose sands, (4) natural organic deposits, and (5) debris deposited by man. Very soft clays are susceptible to shear failure, failure by spreading, and excessive settlement. Sometimes soft clay deposits have a zone of stronger clay at the surface, caused by dessication, which if strong enough may eliminate the need for expensive treatment. Sensitive clays are brittle and even though possessing considerable strength in the undisturbed state, are subject to partial or complete loss of strength upon disturbance. Fortunately,

extremely sensitive clays are rare. Loose sands are also sensitive to disturbance and can liquefy and flow when subjected to shock or even shear strains caused by erosion at the toe of slopes. Most organic soils are very compressible and exhibit low shear strength. The physical characteristics and behavior of organic deposits such as peat can sometimes be predicted with some degree of accuracy. Highly fibrous organic soils with water contents of 500 percent or more generally consolidate and gain strength rapidly. The behavior of debris deposited by man, such as industrial and urban refuse, is so varied in character that its physical behavior is difficult, if not impossible, to predict. The following paragraphs discuss methods of dealing with foundations that are inadequate for construction of proposed levees.

b. Excavation and replacement. The most positive method of dealing with excessively compressible and/or weak foundation soils is to remove them and backfill the excavation with suitable compacted material. This procedure is feasible only where deposits of unsuitable material are not excessively deep. Excavation and replacement should be used wherever economically feasible.

c. Displacement by end dumping.

(1) Frequently low levees must be constructed across sloughs and stream channels whose bottoms consist of very soft fine-grained soils (often having high organic content). Although the depths of such deposits may not be large, the cost of removing them may not be justified, as a levee of adequate stability can be obtained by end-dumping fill from one side of the slough or channel, pushing the fill over onto the soft materials, and continually building up the fill until its weight displaces the foundation soils to the sides and front. By continuing this operation, the levee can finally be brought to grade. The fill should be advanced with a V-shaped leading edge so that the center of the fill is most advanced, thereby displacing the soft material to both sides. A wave of displaced foundation material will develop (usually visible) along the sides of the fill and should not be removed. A disadvantage of this method is that all soft material may not be displaced which could result in slides as the embankment is brought up and/or differential settlement after construction. Since this type of construction produces essentially uncompacted fill, the design of the levee section should take this into account.

(2) When this method of foundation treatment is being considered for a long reach of levee over unstable areas such as swamps, the possibility of facilitating displacement by blasting methods should be evaluated. Blasters' Handbook (1966) (Appendix A-2) presents general information on methods of blasting used to displace soft materials.

(3) The end-dumping method is also used to provide a working platform on soft foundation soils upon which construction equipment can operate to construct a low levee. In this case, only enough fill material is hauled in and dozed onto the foundation to build a working platform or pad upon which the levee proper can be built by conventional equipment and methods. Material forming the working platform should not be stockpiled on the platform or a shear failure may result. Only small dozers should be used to spread and work the material. Where the foundation is extremely weak, it may be necessary to use a small clamshell to spread the material by casting it over the area.

d. Stage construction.

(1) General. Stage construction refers to the building of an embankment in stages or intervals of time. This method is used where the strength of the foundation material is inadequate to support the entire weight of the embankment, if built continuously at a pace faster than the foundation material can drain. Using this method, the embankment is built to intermediate grades and allowed to rest for a time before placing more fill. Such rest periods permit dissipation of pore water pressures which results in a gain in strength so that higher embankment loadings may be supported. Obviously this method is appropriate when pore water

pressure dissipation is reasonably rapid because of foundation stratification resulting in shorter drainage paths. This procedure works well for clay deposits interspersed with highly pervious silt or sand seams. However, such seams must have exits for the escaping water otherwise they themselves will become seats of high pore water pressure and low strengths (pressure relief wells can be installed on the landside to increase the efficiency of pervious layers in foundation clays). Initial estimates of the time required for the needed strength gain can be made from results of consolidation tests and study of boring data. Piezometers should be installed during construction to monitor the rate of pore water dissipation, and the resumption and rate of fill placement should be based on these observations, together with direct observations of fill and foundation behavior. Disadvantages of this method are the delays in construction operation, and uncertainty as to its scheduling and efficiency.

(2) Prefabricated vertical (wick) drains. If the expected rate of consolidation under stage construction is unacceptably slow, it may be increased by the use of prefabricated vertical (wick) drains. Such drains are geotextile wrapped plastic cores that provide open flowage areas in the compressible stratum. Their purpose is to reduce the length of drainage paths, thus speeding up primary consolidation. The wick drains are very thin and about 101.6 mm (4 in.) wide. They can be pushed into place through soft soils over 30.5 m (100 ft) deep. Before the drains are installed, a sand drainage blanket is placed on the foundation which serves not only to tie the drains together and provide an exit for escaping pore water, but as a working platform as well. This drainage blanket should not continue across the entire base width of the embankment, but should be interrupted beneath the center.

e. Densification of loose sands. The possibility of liquefaction of loose sand deposits in levee foundations may have to be considered. Since methods for densifying sands, such as vibroflotation, are costly, they are generally not considered except in locations of important structures in a levee system. Therefore, defensive design features in the levee section should be provided, such as wider levee crest, and flatter slopes.

Section III *Embankments*

7-4. Embankment Construction Control

a. Construction control of levees may present somewhat different problems from that of dams because:

(1) Construction operations may be carried on concurrently along many miles of levee, whereas the majority of dams are less than about 0.8 km (0.5 mile) in length and only in a few cases are dams longer than 4.8 km (3 miles). This means that more time is needed to cover the operations on many levee jobs.

(2) While inspection staff and testing facilities are located at the damsite, levee inspection personnel generally operate out of an area office which may be a considerable distance from the levee project.

(3) There are frequently fiscal restraints which prevent assigning an optimum number of inspectors on levee work or even one full-time inspector on small projects. Under these conditions, the inspectors used must be well-trained to observe construction operations, minimizing the number of field density tests in favor of devoting more time to visual observations, simple measurements, and expedient techniques of classifying soils, evaluating the suitability of their water content, observing behavior of construction equipment on the fill, and indirectly assessing compacted field densities.

b. Although it has previously been stated that only limited foundation exploration and embankment design studies are generally needed in areas where levee heights are low and foundation conditions adequate

(i.e., no question of levee stability), the need for careful construction control by competent inspection exists as well as at those reaches where comprehensive investigations and analyses have been made. Some of the things that can happen during construction that can cause failure or distress of even low embankments on good foundations are given in Table 7-2.

Table 7-2
Embankment Construction Deficiencies

Deficiency	Possible Consequences
Organic material not stripped from foundation	Differential settlements; shear failure; internal erosion caused by through seepage
Highly organic or excessively wet or dry fill	Excessive settlements; inadequate strength
Placement of pervious layers extending completely through the embankment	Allows unimpeded through seepage which may lead to internal erosion and failure
Inadequate compaction of embankment (lifts too thick, haphazard coverage by compacting equipment, etc.)	Excessive settlements; inadequate strength; through seepage
Inadequate compaction of backfill around structures in embankment	Excessive settlements; inadequate strength; provides seepage path between structure and material which may lead to internal erosion and failure by piping

7-5. Embankment Zoning

As a general rule levee embankments are constructed as homogeneous sections because zoning is usually neither necessary nor practicable. However, where materials of varying permeabilities are encountered in borrow areas, the more impervious materials should be placed toward the riverside of the embankment and the more pervious material toward the landside slope. Where required to improve underseepage conditions, landside berms should be constructed of the most pervious material available and riverside berms of the more impervious materials. Where impervious materials are scarce, and the major portion of the embankment must be built of pervious material, a central impervious core can be specified or, as is more often done, the riverside slope of the embankment can be covered with a thick layer of impervious material. The latter is generally more economical than a central impervious core and, in most cases, is entirely adequate.

7-6. Protection of Riverside Slopes

a. The protection needed on a riverside slope to withstand the erosional forces of waves and stream currents will vary, depending on a number of factors:

(1) The length of time that floodwaters are expected to act against a levee. If this period is brief, with water levels against the levee continually changing, grass protection may be adequate, but better protection may be required if currents or waves act against the levee over a longer period.

(2) The relative susceptibility of the embankment materials to erosion. Fine-grained soils of low plasticity (or silts) are most erodible, while fat clays are the least erodible.

(3) The riverside slope may be shielded from severe wave attack and currents by timber stands and wide space between the riverbank and the levee.

(4) Structures riverside of the levee. Bridge abutments and piers, gate structures, ramps, and drainage outlets may constrict flow and cause turbulence with resultant scour.

(5) Turbulence and susceptibility to scour may result if levee alignment includes short-radius bends or if smooth transitions are not provided where levees meet high ground or structures.

(6) Requirements for slope protection are reduced when riverside levee slopes are very flat as may be the case for levees on soft foundations. Several types of slope protection have been used including grass cover, gravel, sand-asphalt paving, concrete paving, articulated concrete mat, and riprap, the choice depending upon the degree of protection needed and relative costs of the types providing adequate protection.

b. Performance data on existing slopes under expected conditions as discussed above are invaluable in providing guidance for the selection of the type of slope protection to be used.

c. Sometimes it may be concluded that low cost protection, such as grass cover, will be adequate in general for a levee reach, but with a realization that there may be limited areas where the need for greater protection may develop under infrequent circumstances. If the chances of serious damage to the levee in such areas are remote, good engineering practice would be to provide such increased protection only if and when actual problems develop. Of course, it must be possible to accomplish this expeditiously so that the situation will not get out of hand. In any event, high-class slope protection, such as riprap, articulated mat, or paving should be provided on riverside slopes at the following locations:

(1) Beneath bridges, since adequate turf cannot be generally established because of inadequate sunlight.

(2) Adjacent to structures passing through levee embankments.

d. Riprap is more commonly used than other types of revetments when greater protection than that afforded by grass cover is required because of the relative ease of handling, stockpiling, placement, and maintenance. Guidance on the design of riprap revetment to protect slopes against currents is presented in EM 1110-2-1601. Where slopes are composed of erodible granular soils or fine-grained soils of low plasticity, a bedding layer of sand and gravel or spalls, or plastic filter cloth should be provided beneath the riprap.

e. When suitable rock is not available within economical haul distances, soil cement may provide the most economical slope protection (see Appendix G).

Chapter 8 Special Features

Section I *Pipelines and Other Utility Lines Crossing Levees*

8-1. General Considerations

a. Serious damage to levees can be caused by inadequately designed or constructed pipelines, utility conduits, or culverts (all hereafter referred to as “pipes”) beneath or within levees. Each pipe crossing should be evaluated for its potential damage which would negatively impact the integrity of the flood protection system and could ultimately lead to catastrophic failure. During high water, seepage tends to concentrate along the outer surface of pipes resulting in piping of fill or foundation material. High water also results in uplift pressures that may cause buoyancy of some structures. Seepage may also occur because of leakage from the pipe. In the case of pipes crossing over levees, leakage can cause erosion in the slopes. In addition, loss of fill or foundation material into the pipe can occur if joints are open. The methods of pipe installation should be understood by the designer to anticipate problems that may occur. Some of the principal inadequacies that are to be avoided or corrected are as follows:

- (1) Pipes having inadequate strength to withstand loads of overlying fill or stresses applied by traffic.
- (2) Pipe joints unable to accommodate movements resulting from foundation or fill settlement.
- (3) Unsuitable backfill materials or inadequately compacted backfill.
- (4) High pressures from directional drilling that could result in hydro-fracturing the surrounding materials.

b. Some state and local laws prohibit pipes from passing through or under certain categories of levees. As a general rule, this should not be done anyway, particularly in the case of pressure lines. However, since each installation is unique, pipes in some instances may be allowed within the levee or foundation. Major factors to be considered in deciding if an existing pipe can remain in place under a new levee or must be rerouted over the levee, or if a new pipe should be laid through or over the levee are as follows:

- (1) The height of the levee.
- (2) The duration and frequency of high water stages against the levee.
- (3) The susceptibility to piping and settlement of levee and foundation soils.
- (4) The type of pipeline (low or high pressure line, or gravity drainage line).
- (5) The structural adequacy of existing pipe and pipe joints, and the adequacy of the backfill compaction.
- (6) The feasibility of providing closure in event of ruptured pressure lines, or in the event of failure of flap valves in gravity lines during high water.
- (7) The ease and frequency of required maintenance.

- (8) The cost of acceptable alternative systems.
- (9) Possible consequences of piping or failure of the pipe.
- (10) Previous experience with the owner in constructing and maintaining pipelines.

General criteria for pipes crossing levees are given in Table 8-1.

Table 8-1
Criteria for Pipelines Crossing Levees

Pipelines	Leaving Existing Pipeline in Foundations of Proposed Levees	New Pipeline Installation	
		Pipes Through Levees	Pipes Over Levees
Must be known to be in good condition	X		
Must have adequate strength to with-stand levee loading	X	X	
Must have adequate cover as needed to prevent damage by vehicular traffic or heavy equipment			X
Must have adequate cover for frost protection			X
Must have sufficient flexibility in joints to adjust under expected settlement and stretching of pipe	X	X	X
Pressure lines must have provisions for rapid closure in event of leakage or rupture	X	X	X
Gravity discharge pipes must have provisions for emergency closure in event of inoperative flap valves on riverside end	X	X	
Must have pervious backfill under landside third of levee where:			
a. Foundation materials are susceptible to piping	X		
b. Levee materials are susceptible to piping		X	

8-2. General Considerations for Pipelines Crossing Through or Under Levees

a. General. As has been noted previously, it is preferable for all pipes to cross over a levee rather than penetrate the embankment or foundation materials. This is particularly true for pipes carrying gas or fluid under pressure. Before consideration is given to allowing a pressure pipe (and possibly other types of pipe) to extend through or beneath the levee, the pipe owner should provide an engineering study to support his request for such installation. The owner, regardless of the type of pipe, should show adequate capability to properly construct and/or maintain the pipe. Future maintenance of pipe by the owner must be carefully

evaluated. It may be necessary to form an agreement to the effect that should repairs to a pipe in the levee become necessary, the pipe will be abandoned, sealed, and relocated over the levee.

b. Existing pipes

(1) All existing pipelines must be located prior to initiation of embankment construction. As previously noted, inspection trenches may reveal abandoned pipes not on record. It is preferable that all abandoned pipes be removed during grubbing operations and the voids backfilled. Any existing pipe should meet or be made to meet the criteria given in Table 8-1. If this is not feasible and removal is not practical, they should be sealed, preferably by completely filling them with concrete. Sealed pipes must also meet the criteria given in Table 8-1 relating to prevention of seepage problems.

(2) In general, existing pressure pipes should be relocated over the proposed new levee. Rupture or leakage from such pipes beneath a levee produces extremely high gradients that can have devastating effects on the integrity of the foundation. Therefore, as indicated by the criteria in Table 8-1, it is imperative that pressure pipes be fitted with rapid closure valves or devices to prevent escaping gas or fluid from damaging the foundation.

(3) Although gravity drainage lines may be allowed or even required after the levee is completed, it is likely that existing pipes will not have sufficient strength to support the additional load induced by the embankment. Therefore, existing pipes must be carefully evaluated to determine their supporting capacity before allowing their use in conjunction with the new levee.

c. New Pipelines. Generally, the only new pipelines allowed to penetrate the foundation or embankment of the levee are gravity drainage lines. The number of gravity drainage structures should be kept to an absolute minimum. The number and size of drainage pipes can be reduced by using such techniques as ponding to reduce the required pipe capacity.

8-3. General Considerations for Pipelines Crossing Over Levees

In the past the term and concept of freeboard was used to account for hydraulic, geotechnical, construction, operation and maintenance uncertainties. Pipelines crossing over the levee were encouraged to be within the freeboard zone to reduce or eliminate many of the dangers that are inherent with pipelines crossing through the embankment or foundation. The term and concept of freeboard to account for these uncertainties is no longer used in the design of levee projects. Therefore, since freeboard no longer exists, pipes must cross over the completed levee cross section. Problems do exist, however, with pipelines crossing over the levee. These pipes must be properly designed and constructed to prevent (a) flotation if submerged, (b) scouring or erosion of the embankment slopes from leakage or currents, and (c) damage from debris carried by currents, etc. In some areas climatic conditions will require special design features. Guidance on design methods and construction practices will be given later in this chapter.

8-4. Pipe Selection

a. EM 1110-2-2902 contains a discussion of the advantages and disadvantages of various types of pipe (i.e., corrugated metal, concrete, cast iron, steel, clay, etc.). The selection of a type of pipe is largely dependent upon the substance it is to carry, its performance under the given loading, including expected deflections or settlement, and economy. Although economy must certainly be considered, the overriding factor must be safety, particularly where urban levees are concerned.

b. The earth load acting on a pipe should be determined as outlined in EM 1110-2-2902. Consideration must also be given to live loads imposed from equipment during construction and the loads from traffic and maintenance equipment after the levee is completed. The respective pipe manufacturers organizations have recommended procedures for accounting for such live loads. These recommended procedures should be followed unless the pipe or roadway owners have more stringent requirements.

c. Required strengths for standard commercially available pipe should be determined by the methods recommended by the respective pipe manufacturers organizations. Where cast-in-place pipes are used, design procedures outlined in EM 1110-2-2902 should be followed. Abrasion and corrosion of corrugated steel pipe should be accounted for in design using the method given in Federal Specification WW-P-405B(1) (Appendix A) for the desired design life. The design life of a pipe is the length of time it will be in service without requiring repairs. The term does not imply the pipe will fail at the end of that time. Normally, a design life of 50 years can be economically justified. Corrugated pipe should always be galvanized and protected by a bituminous or other acceptable coating as outlined in EM 1110-2-2902. Protective coatings may be considered in determining the design life of a pipe.

d. Leakage from or infiltration into any pipe crossing over, through, or beneath a levee must be prevented. Therefore, the pipe joints as well as the pipe itself must be watertight. For pipes located within or beneath the embankment, the expected settlement and outward movement of the soil mass must be considered. Where considerable settlement is likely to occur the pipe should be cambered (para 8-7). Generally, flexible corrugated metal pipes are preferable for gravity lines where considerable settlement is expected. Corrugated metal pipe sections should be joined by exterior coupling bands with a gasket to assure watertightness. Where a concrete pipe is required and considerable settlement is anticipated, a pressure-type joint with concrete alignment collars should be used. The collars must be designed either to resist or accommodate differential movement without losing watertight integrity. Where settlement is not significant, pressure-type joints capable of accommodating minor differential movement are sufficient. Design details for concrete collars are shown in EM 1110-2-2902. Cast iron and steel pipes should be fitted with flexible bolted joints. Steel pipe sections may be welded together to form a continuous conduit. All pressure pipes should be pressure tested at the maximum anticipated pressure before they are covered and put into use.

e. During the design, the potential for electrochemical or chemical reactions between the substratum materials or groundwater and construction materials should be determined. If it is determined that there will be a reaction, then the pipe and/or pipe couplings should be protected. The protective measures to be taken may include the use of cathodic protection, coating of the pipe, or use of a corrosion-resistant pipe material.

8-5. Antiseepage Devices

a. Antiseepage devices have been employed in the past to prevent piping or erosion along the outside wall of the pipe. The term “antiseepage devices” usually referred to metal diaphragms (seepage fins) or concrete collars that extended from the pipe into the backfill material. The diaphragms and collars were often referred to as “seepage rings.” However, many piping failures have occurred in the past where seepage rings were used. Assessment of these failures indicated that the presence of seepage rings often results in poorly compacted backfill at its contact with the structure.

b. Where pipes or conduits are to be constructed through new or existing levees:

(1) Seepage rings or collars should not be provided for the purpose of increasing seepage resistance. Except as provided herein, such features should only be included as necessary for coupling of pipe sections or to accommodate differential movement on yielding foundations. When needed for these purposes, collars with a minimum projection from the pipe surface should be used.

(2) A 0.45-m (18-in.) annular thickness of drainage fill should be provided around the landside third of the pipe, regardless of the size and type of pipe to be used, where landside levee zoning does not provide for such drainage fill. For pipe installations within the levee foundation, the 0.45-m (18-in.) annular thickness of drainage fill shall also be provided, to include a landside outlet through a blind drain to ground surface at the levee toe, connection with pervious underseepage features, or through an annular drainage fill outlet to ground surface around a manhole structure. Figure 8-1 shows typical sections of drainage structures through levees. Figure 8-2 shows typical precast conduits through the levee.

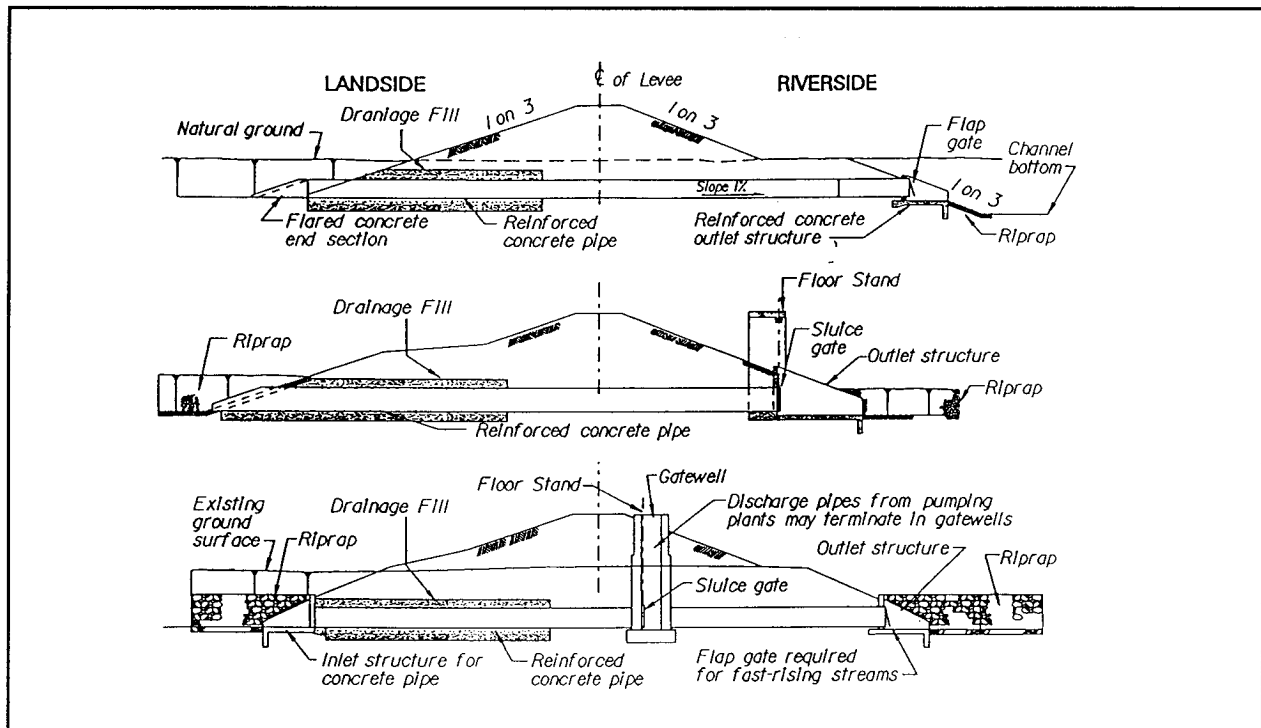

Figure 8-1. Typical sections, drainage structures through levees

8-6. Closure Devices

a. All pipes allowed to penetrate the embankment or foundation of a levee must be provided with devices to assure positive closure. Gravity lines should be provided with flap-type or slide-type service gates on the riverside of the levee. Automatic flap-type gates are usually used where the water is likely to rise to the "Gate Closing Stage" rather suddenly and where the water stage is likely to fluctuate within a few feet above and below the "Gate Closing Stage" for prolonged periods of time during flood season. Automatic gates are also required on slower rising streams or bodies of water where frequent visits from operating personnel are not practical.

b. Slide-type gates are usually preferred as service gates where the rate of rise of the water during major floods is slow, enough (minimum of 12-hr flood prediction time) to give ample time for safe operation. The principal advantages of the slide gate in comparison with automatic flap gates are greater reliability of operation and the ease with which emergency closure can be made in event obstructions prevent closure of the gate. Usually emergency closure can be made by filling the manhole with sandbags. The obvious

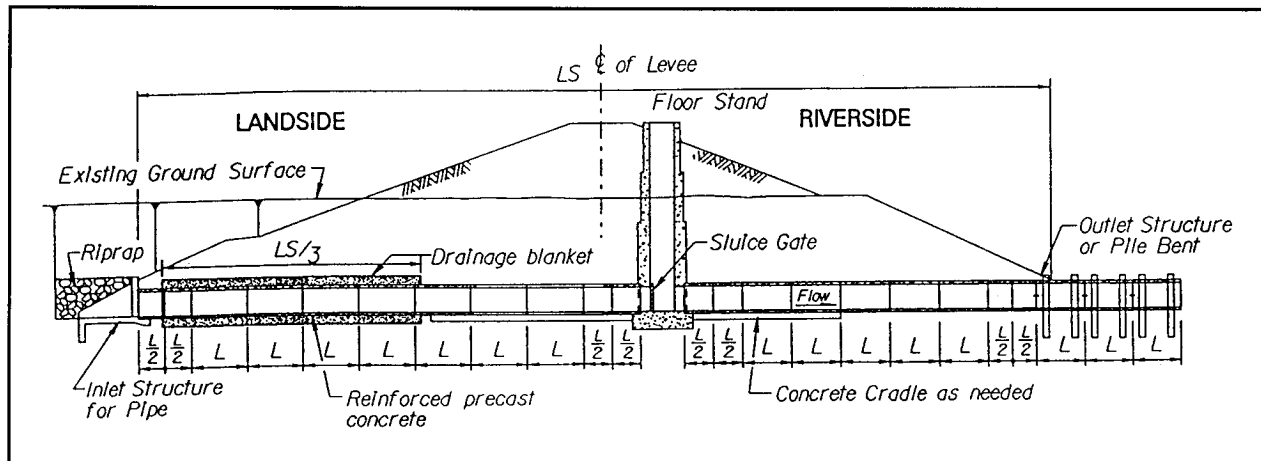

Figure 8-2. Typical precast conduit (levees)

disadvantage of slide type gates is that personnel must be on hand for their operation. Also their initial cost is generally greater than that for a flap-type gate.

c. A slide-type gate with a flap-type gate attachment is often used and affords the advantages of automatic flap gate operation with the added safety of the slide-type gate. Such installations usually eliminate the need for a supplemental emergency gate as described below.

d. Experience has shown that service gates occasionally fail to close completely during critical flood periods because of clogging by debris, mechanical malfunctions, or other causes. This, of course, can cause flooding of the protected areas. Supplemental emergency gates are intended to minimize these risks insofar as necessary and economically practical. For an emergency gate to be effective it must be located so that its controls are accessible during flood stage. Provisions required for emergency protection of other areas should be consistent with the risks and cost involved.

e. Pressure pipes should be fitted with valves at various stations that can be closed rapidly to prevent gas or fluid from escaping within or beneath a levee should the pipe rupture within these areas. Provisions for closure of pressure pipes on the water side must also be provided to prevent backflow of floodwater into the protected area should the pipe rupture. These requirements should generally be followed in other areas, but may be relaxed to be consistent with the risks and costs involved.

8-7. Camber

The alignment of a gravity structure must be such as to provide for a continuous slope toward the outlet. Settlement of the embankment and foundation can significantly alter the initial grade line of a pipe. Therefore, the expected settlement of the levee must be considered in establishing the initial grade line. If the settlement will result in an upward gradient in the direction of flow or not allow the desired gradient to be maintained, the pipe should be cambered. The amount of camber required can usually be taken as the mirror image of the settlement curve along a line established by the final required grade. The camber should then be laid out, preferably as a vertical curve, on a grade such that all parts of the pipe will slope toward the outlet when installed. If the gradient of the pipe is limited and the camber will initially result in a slope away from the outlet, the portion of the pipe from the inlet up to the point of greatest load may be installed level. The remaining portion of the pipe is then installed on a vertical curve tangent to the first portion of the pipe.

Regardless of the type of pipe selected, movements at the joints must be considered as discussed in paragraph 8-4d.

8-8. Installation Requirements

a. General. The installation of pipes or other structures within the levee or foundation probably requires the greatest care and the closest supervision and inspection of any aspect of levee construction. Most failures of levee systems have initiated at the soil-structure interface and therefore every effort must be made to ensure that these areas are not susceptible to piping. Of overriding importance is good compaction of the backfill material along the structure. Pipes installed by open trench excavation should be installed in the dry and a dewatering system should be used where necessary. Pipes installed by directional drilling, microtunneling, or other trenchless methods require special consideration.

b. Pipes crossing through or beneath levees

(1) The preferred method of installing pipes within the embankment or foundation of a levee has historically been by the open cut method. Preferably, new levees should be brought to a grade about 610.8 mm (2 ft) above the crown of the pipe. This allows the soil to be preconsolidated before excavating the trench. The trench should be excavated to a depth of about 610.8 mm (2 ft) below the bottom of the pipe and at least 1.2 m (4 ft) wider than the pipe. The excavated material should be selectively stockpiled so that it can be replaced in a manner that will not alter the embankment zoning if there is some or will result in the more impervious soils on the riverside of the levee.

(2) After the trench has been excavated, it should be backfilled to the pipe invert elevation. In impervious zones, the backfill material should be compacted with mechanical compactors to 95 percent standard density at about optimum water content.

(3) First-class bedding should be used for concrete pipe and other rigid pipe, as shown in EM 1110-2-2902 except no granular bedding should be used in impervious zones. For flexible pipe, the trench bottom should be flat to permit thorough tamping of backfill under the haunches of the pipe. Backfill should be compacted to 95 percent standard density at about optimum water content. The backfill should be brought up evenly on both sides of the pipe to avoid unequal side loads that could fail or move the pipe. Special care must be taken in the vicinity of any protrusions such as joint collars to ensure proper compaction. Where granular filter material is required, it should be compacted to a minimum of 80 percent relative density. In areas where backfill compaction is difficult to achieve, flowable, low strength concrete fill has been used to encapsulate pipes in narrow trenches.

(4) In existing levees, the excavation slopes should be stable, meet OSHA criteria, but in no case be steeper than 1V on 1H. The excavated material should be selectively stockpiled as was described for new levees. The pipe is installed as described in the previous paragraphs. Impervious material within 0.61 m (2 ft) of the pipe walls should be compacted to 95 percent standard density at optimum water content, with the remainder of the backfill placed at the density and water content of the existing embankment.

(5) Installation of pipes in existing levees by directional drilling, microtunneling, tunneling or jacking may be considered. It is recognized, that in some instances, installation by the open cut method is not feasible or cannot be economically justified. Where trenchless methods are allowed, special considerations are required.

(6) Pipes under levees.

(a) General. Pipes crossing beneath levees also require special considerations. Such crossings should be designed by qualified geotechnical engineers. Pipes constructed with open excavation methods should proceed in accordance with the requirements stated in the above paragraph, Pipes Crossing Through or Beneath Levees. If directional drilling or other trenchless methods are used, seepage conditions may be aggravated by the collapse of levee foundation material into the annular void between the bore and pipe. Penetration through the top stratum of fine-grained materials may concentrate seepage at those locations. Pipes constructed with trenchless methods should proceed only after a comprehensive evaluation of the following: comprehensive understanding of the subsurface soil and groundwater conditions to a minimum depth of 6.1 m (20 ft) below the lowest pipe elevation, locations of the pipe penetration entry and exit, construction procedure, allowable uplift pressures, on-site quality control and quality assurance monitoring during construction operation, grouting of the pipe annulus, backfilling of any excavated areas, and repair and reinstatement of the construction-staging areas. Guidance for construction of pipelines beneath levees using directional drilling is provided in Appendix A of WES CPAR-GL-98-1 (Staheli, et al. 1998). Guidance for construction of pipelines using microtunneling methods is provided in WES CPAR-GL-95-2 (Bennett, et al. 1995).

(b) Pipes installed by directional drilling. The pipe entry or exit location, when located on the protected (land) side, should be set back sufficiently from the land side levee toe to ensure that the pipe penetrates some depth of a pervious sand stratum but is no less than 91.5 m (300 ft) from the centerline of the levee crest. The pipe entry or exit location, when located on the unprotected (river) side, should be located at least 6.1 m (20 ft) riverward of the levee stability control line. This is the distance between the river side levee toe and an eroding bank line which will maintain the minimum design criteria for slope stability.

If directional drilling is to be used, the depth of the pipe under the levee should be at a level to maintain an adequate factor of safety against uplift from the pressurized drilling fluid during the drilling operation. A positive means of maintaining an open vent to the surface should be required whether through bored holes or downhole means while installing the drill pipe.

The drilling fluid should consist of a noncolloidal lubricating admixture to ensure suspension and removal of drilling cuttings. The pilot hole should be advanced at a rate to maintain a continuous return flow. The annular space should be sufficient to ensure that no blockage occurs with the drilling cuttings. The prereamer boring diameter should be of sufficient size to ensure that the production pipe can be advanced without delay and undue stress to the surrounding soils. The prereamer boring operation should be continuous for the down-slope and up-slope cutting segments. Excessive drilling fluid pressures can hydraulically fracture the levee foundation and levee embankment and should be avoided.

Where economically feasible, the pipeline should be bored through rock where the pipeline crosses the levee centerline.

The maximum allowable mud pressure acting against the borehole wall should be evaluated using the Delft equation presented in the Appendix A of WES CPAR-GL-98-1 (Staheli, et al., 1998). During construction, the actual mud pressure existing in the borehole must be measured by a pressure measuring device located on the outside of the drill string no more than 5 ft from the drill bit. The drilling operator should be required to monitor these pressures and adjust the drilling mud pressure so as not to exceed the maximum pressure determined by Delft equation.

Where the casing pipe is carrying multiple fibre optic cables and each cable is installed within its own HDPE inner duct, the detail shown in Figure 8-3a should be used to prevent preferred seepage path (both external and internal). The casing pipe must end in the encasements.

The directional drilling contract should be required to show proof that all of his pressure sensors and readout devices have been calibrated by a national standard within the last 6 months.

A full time inspector, not on directional drilling contractor's payroll, should be required to observe the construction.

The drilling fluid should be processed through an active drilling mud conditioning unit to remove the cuttings from the drill fluid and maintain its viscosity.

c. Pipes crossing over levees. Pipe crossings on the surface of the levee should be designed to counteract uplift of the empty pipe at the design high water stage. This may be accomplished by soil cover, anchors, headwalls, etc. All pipes on the riverside of the levee should have a minimum of 305 mm (1 ft) of soil cover for protection from debris during high water. It is desirable for pipe on the landward side to also be covered with soil. Pipes crossing beneath the levee crown should be provided with sufficient cover to withstand vehicular traffic as outlined in paragraph 8-4b. Depth of cover should also be at least the depth of local frost protection. Where mounding of soil over the pipe is required, the slope should be gentle to allow mowing equipment or other maintenance equipment to operate safely on the slopes. The approach ramps on the levee crown should not exceed 1V on 10H in order to allow traffic to move safely on the crown. The trenching details for pipelines cross-up and over-levees are shown in Figure 8-3b and Figure 8-3c.

Section II

Access Roads and Ramps

8-9. Access Roads

a. Access road to levee. Access roads should be provided to levees at reasonably close intervals in cooperation with state and local authorities. These roads should be all-weather roads that will allow access for the purpose of inspection, maintenance, and flood-fighting operations.

b. Access road on levee. Access roads, sometimes referred to as patrol roads, should be provided also on top of the levees for the general purpose of inspection, maintenance, and flood-fighting operations. This type of road should be surfaced with a suitable gravel or crushed stone base course that will permit vehicle access during wet weather without causing detrimental effects to the levee or presenting safety hazards to the levee inspection and maintenance personnel. The width of the road surfacing will depend upon the crown width of the levee, where roadway additions to the crown are not being used, and upon the function of the roadway in accommodating either one- or two-way traffic. On levees where county or state highways will occupy the crown, the type of surfacing and surfacing width should be in accordance with applicable county or state standards. The decision as to whether the access road is to be opened to public use is to be made by the local levee agency which owns and maintains the levee.

(1) Turnouts. Turnouts should be used to provide a means for the passing of two motor vehicles on a one-lane access road on the levee. Turnouts should be provided at intervals of approximately 762 m (2500 ft), provided there are no ramps within the reach. The exact locations of the turnouts will be dependent upon various factors such as sight distance, property lines, levee alignment, and desires of local interests. An example turnout for a levee with a 3.65 m (12-ft) levee crown is shown in Figure 8-4.

(2) Turnarounds. Turnarounds should be provided to allow vehicles to reverse their direction on all levees where the levee deadends, and no ramp exists in the vicinity of the deadend. An example turnaround for a levee with a 3.65-m (12-ft) crown is shown in Figure 8-5.

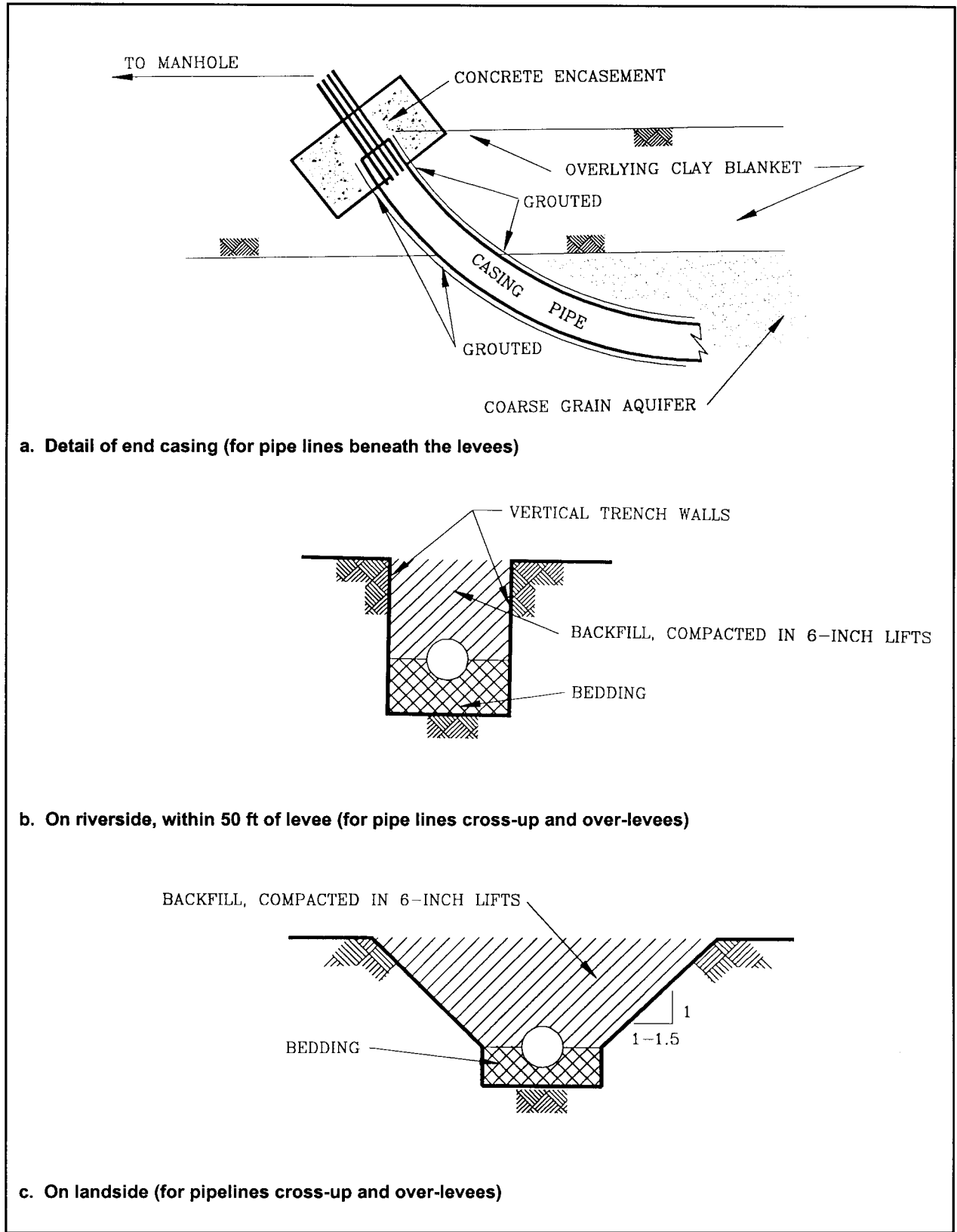

Figure 8-3. Details of pipeline levee crossing

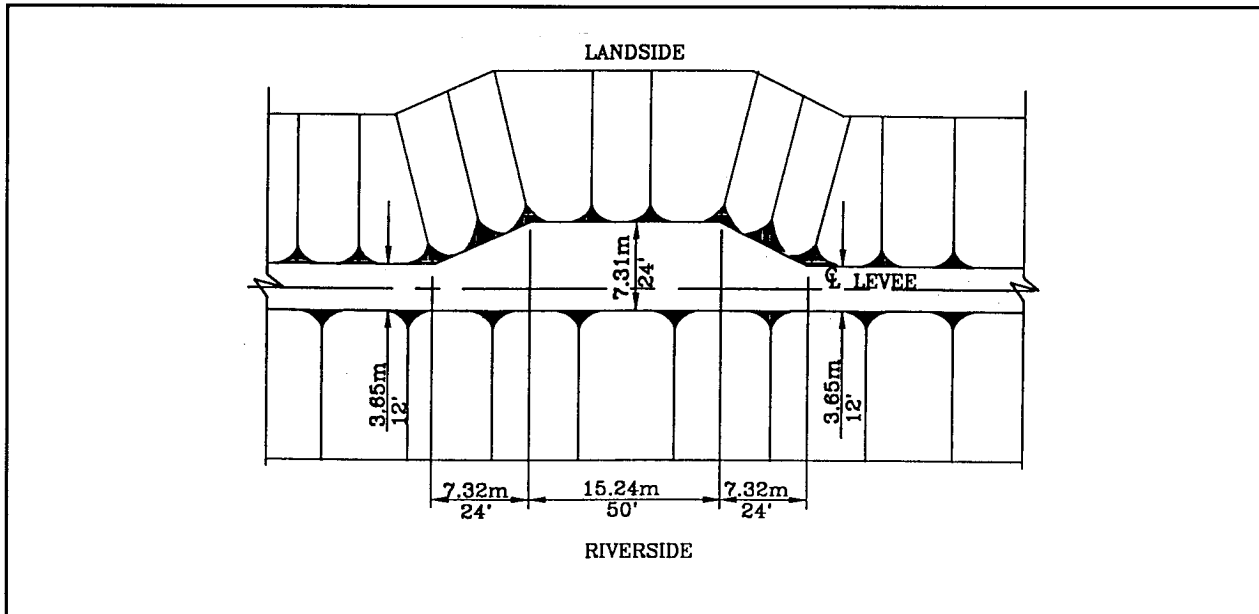

Figure 8-4. Example of levee turnout

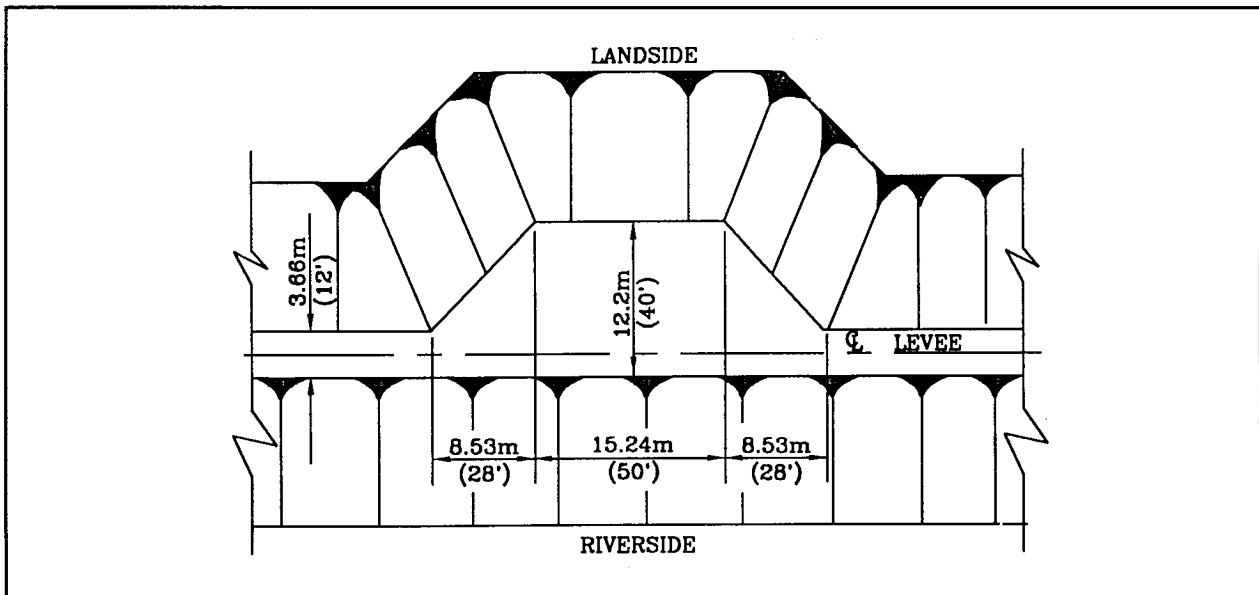

Figure 8-5. Example of levee turnaround

8-10. Ramps

a. Ramps should be provided at sufficient locations to permit vehicular traffic to access onto and from the levee. Ramps may be located on both the landside and the riverside of the levee. Ramps on the landside of the levee are provided to connect access roads leading to a levee with access roads on top of a levee and

at other convenient locations to serve landowners who have property bordering the levee. Ramps are also provided on some occasions on the riverside of the levee to connect the access road on top of the levee with existing levee traverses where necessary. The actual locations of the ramps should have the approval of the local levee agency which owns and maintains the levee. When used on the riverside of the levee, they should be oriented to minimize turbulence during high water.

b. Ramps are classified as public or private in accordance with their function. Public ramps are designed to satisfy the requirements of the levee owner: state, county, township, or road district. Private ramps are usually designed with less stringent requirements and maximum economy in mind. Side-approach ramps should be used instead of right angle road ramps because of significant savings in embankment. The width of the ramp will depend upon the intended function. Some widening of the crown of the levee at its juncture with the ramp may be required to provide adequate turning radius. The grade of the ramp should be no steeper than 10 percent. Side slopes on the ramp should not be less than 1V on 3H to allow grass-cutting equipment to operate. The ramp should be surfaced with a suitable gravel or crushed stone. Consideration should be given to extending the gravel or crushed stone surfacing to the levee embankment to minimize erosion in the gutter. In general, private ramps should not be constructed unless they are essential and there is assurance that the ramps will be used. Unused ramps lead to maintenance neglect.

c. Both public and private ramps should be constructed only by adding material to the levee crown and slopes. The levee section should never be reduced to accommodate a ramp.

Section III

Levee Enlargements

8-11. General

The term levee enlargement pertains to that addition to an existing levee which raises the grade. A higher levee grade may be required for several reasons after a levee has been constructed. Additional statistical information gathered from recent floodings or recent hurricanes may establish a higher project flood elevation on a river system or a higher elevation for protection from incoming tidal waves produced by hurricane forces in low-lying coastal areas. The most economical and practical plan that will provide additional protection is normally a levee enlargement. Levee enlargements are constructed either by adding additional earth fill or by constructing a flood-wall, "T"-type or "inverted T"-type, on the crown.

8-12. Earth-Levee Enlargement

a. The earth-levee enlargement is normally preferred when possible, since it is usually more economical. This type of enlargement is used on both agricultural and urban levees where borrow sites exist nearby and sufficient right-of-way is available to accommodate a wider levee section.

b. An earth-levee enlargement is accomplished by one of three different methods: riverside, straddle, or landside enlargement. A riverside enlargement is accomplished by increasing the levee section generally at the crown and on the riverside of the levee as shown in Figure 8-6a. A straddle enlargement is accomplished by increasing the levee section on the riverside, at the crown, and on the landside of the levee as shown in Figure 8-6b. A landside enlargement is accomplished by increasing the levee section, generally at the crown and on the landside of the levee as shown in Figure 8-6c. There are advantages and disadvantages to each enlargement method that will have to be looked at for each project. The riverside enlargement would be more costly if the riverside slope has riprap protection and it could also be an encroachment for narrow floodways that would impact top of levee designs. Landside enlargements would require additional right-of-way and larger fill quantities for levees with flatter landside slopes. The straddle

enlargement would require the whole levee system to be stripped with work being done on both sides of the levee.

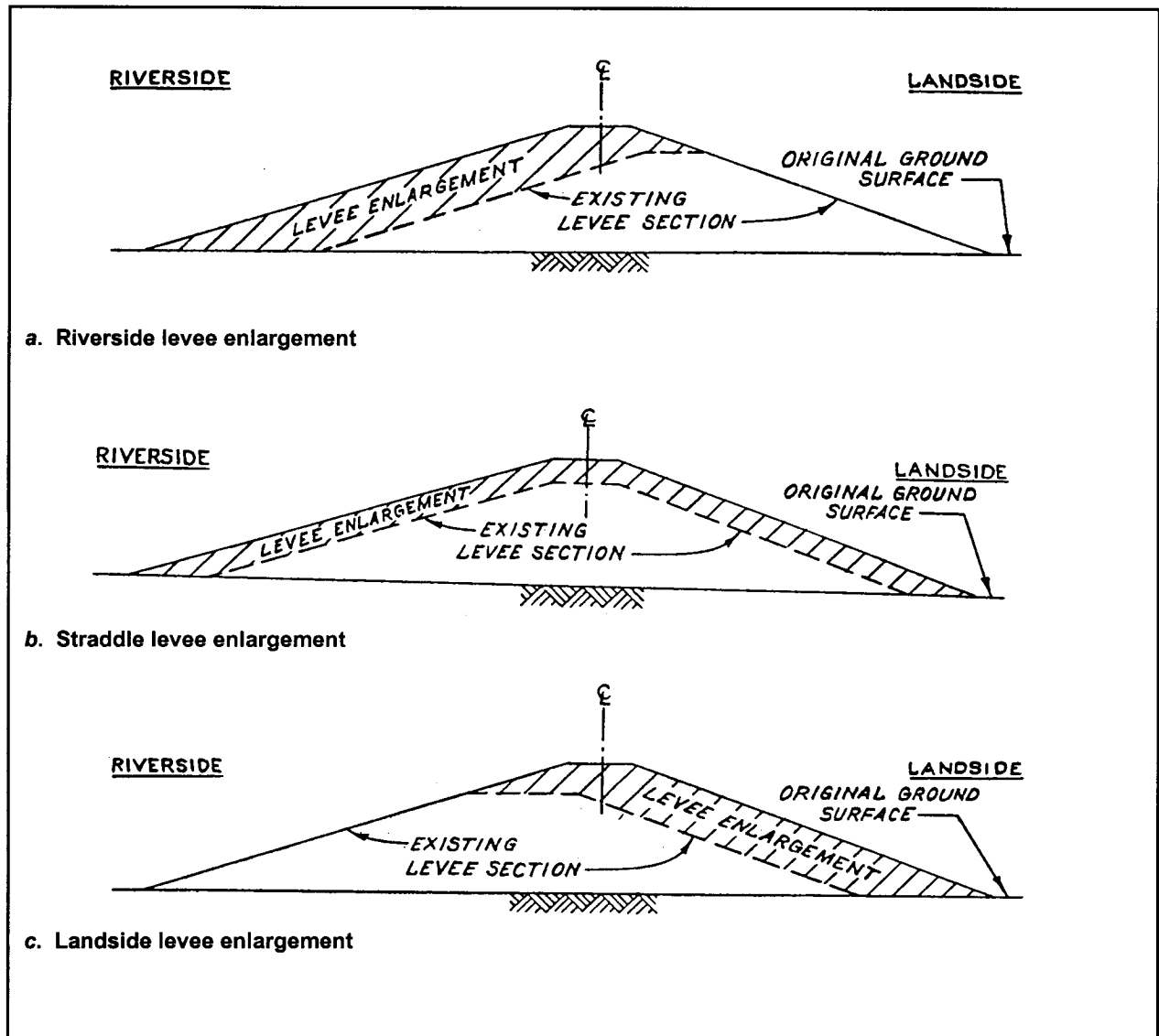

Figure 8-6. Enlargements

c. The modified levee section should be checked for through seepage and underseepage as discussed in Chapter 5 and for foundation and embankment stability as discussed in Chapter 6. Sufficient soil borings should be taken to determine the in situ soil properties of the existing levee embankment for design purposes.

d. An earth-levee enlargement should be made integral with the existing levee. Every effort should be made such that the enlargement has at least the same degree of compaction as the existing levee on which it is constructed. Preparation of the interface along the existing levee surface and upon the foundation should be made to ensure good bond between the enlargement and the surfaces on which it rests. The foundation surface should be cleared, grubbed, and stripped as described in Chapter 6. The existing levee surface upon which the levee enlargement is placed should also be stripped of all low-growing vegetation and organic

topsoil. The topsoil that is removed should be stockpiled for reuse as topsoil for the enlargement. Prior to constructing the enlargement, the stripped surfaces of the foundation and existing levee should be scarified before the first lifts of the enlargements are placed.

8-13. Floodwall-Levee Enlargement

a. A floodwall-levee enlargement is used, when additional right-of way is not available or is too expensive or if the foundation conditions will not permit an increase in the levee section. Economic justification of floodwall-levee enlargement cannot usually be attained except in urban areas. Two common types of floodwalls that are used to raise levee grades are the I wall and the inverted T wall.¹

b. The I floodwall is a vertical wall partially embedded in the levee crown. The stability of such walls depends upon the development of passive resistance from the soil. For stability reasons, I floodwalls rarely exceed 2.13 m (7 ft) above the ground surface. One common method of constructing an I floodwall is by combining sheet pile with a concrete cap as shown in Figure 8-7. The lower part of the wall consists of a row of steel sheet pile that is driven into the levee embankment, and the upper part is a reinforced concrete section capping the steel piling.

c. An inverted T floodwall is a reinforced concrete wall whose members act as wide cantilever beams in resisting hydrostatic pressures acting against the wall. A typical wall of this type is shown in Figure 8-8. The inverted T floodwall is used to make floodwall levee enlargements when walls higher than 2.13 m (7 ft) are required.

d. The floodwall should possess adequate stability to resist all forces which may act upon it. An I floodwall is considered stable if sufficient passive earth resistance can be developed for a given penetration of the wall into the levee to yield an ample factor of safety against overturning. The depth of penetration of the I wall should be such that adequate seepage control is provided. Normally the penetration depth of the I wall required for stability is sufficient to satisfy the seepage requirements. For the inverted T floodwall, the wall should have overall dimensions to satisfy the stability criteria and seepage control as presented in EM 1110-2-2502.

e. The existing levee section should be checked for through seepage and underseepage as discussed in Chapter 5 and for embankment and foundation stability as discussed in Chapter 6 under the additional hydrostatic forces expected. If unsafe seepage forces or inadequate embankment stability result from the higher heads, seepage control methods as described in Chapter 5 and methods of improving embankment stability as described in Chapter 6 may be used. However, some of these methods of controlling seepage and improving embankment stability may require additional right-of-way for construction which could eliminate the economic advantages of the floodwall in comparison with an earth levee enlargement. As in earth levee enlargements, a sufficient number of soil borings should be taken to determine the in situ soil properties of the existing levee embankment for design purposes.

¹ Structural design of crest walls is given in ETL 1110-2-341.

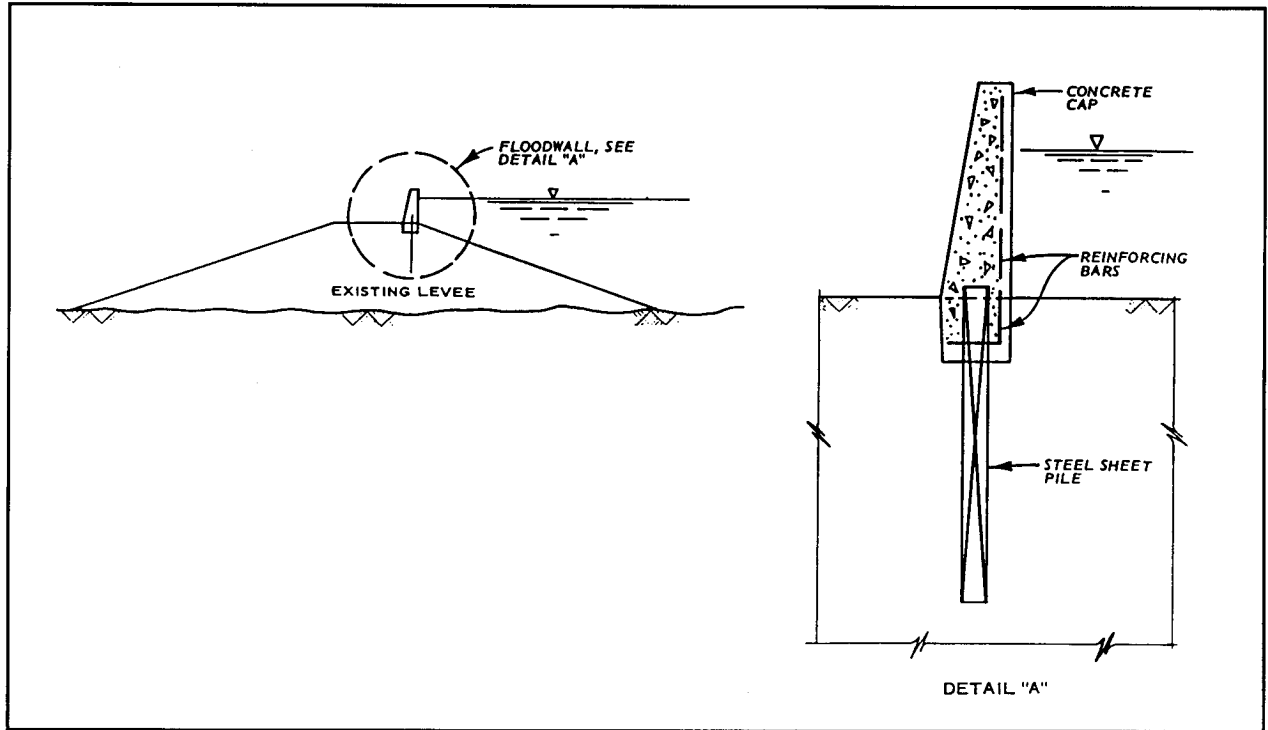

Figure 8-7. I-type floodwall-levee enlargement

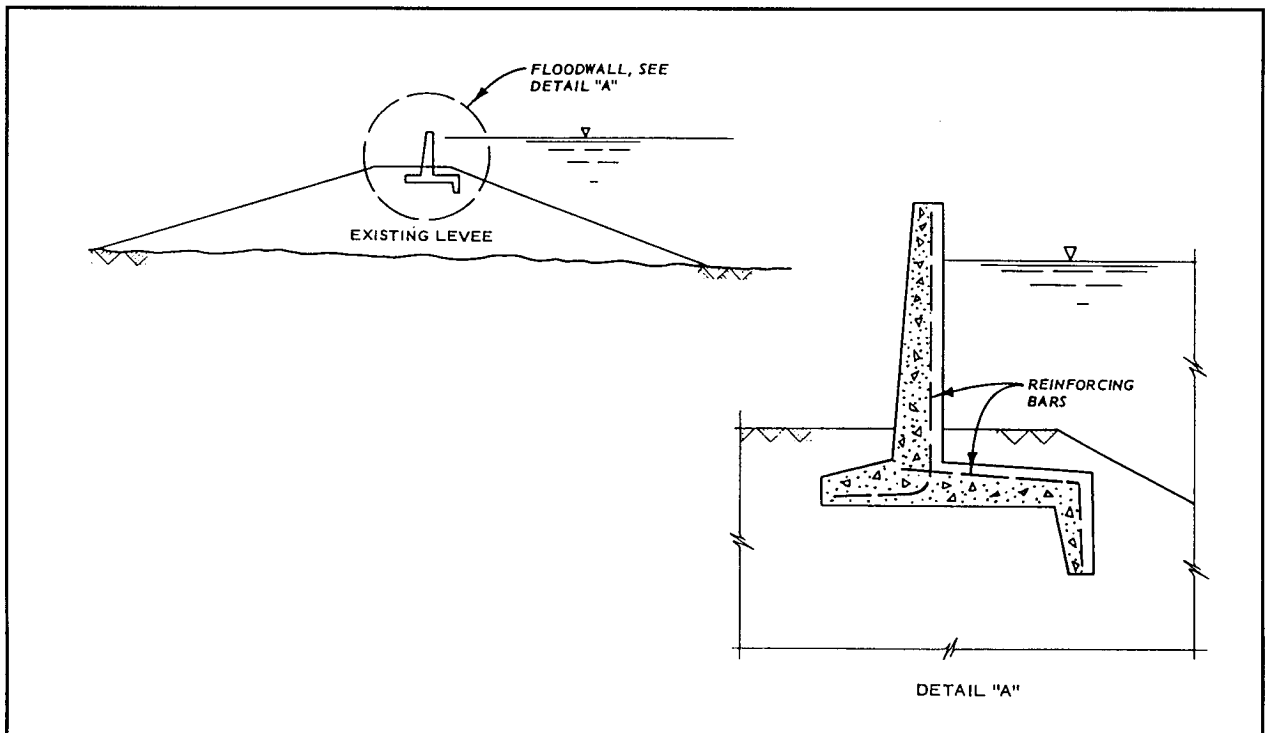

Figure 8-8. Inverted T-type floodwall-levee enlargement

Section IV
Junction with Concrete Closure Structures

8-14. General

In some areas, a flood protection system may be composed of levees, floodwalls, and drainage control structures (gated structures, pumping plants, etc.). In such a system, a closure must be made between the levee and the concrete structure to complete the flood protection. One closure situation occurs when the levee ties into a concrete floodwall or a cutoff wall. In this closure situation the wall itself is usually embedded in the levee embankment. In EM 1110-2-2502 a method of making a junction between a concrete floodwall and levee is discussed and illustrated. Another closure situation occurs when the levee ties into a drainage control structure by abutting directly against the structure as shown in Figure 8-9. In this situation the abutting end walls of the concrete structure should be battered 10V on 1H to ensure a firm contact with the fill.

8-15. Design Considerations

When joining a levee embankment with a concrete structure, items that should be considered in the design of the junction are differential settlement, compaction, and embankment slope protection.

a. Differential settlement. Differential settlement caused by unequal consolidation of the foundation soil at the junction between a relatively heavy levee embankment and a relatively light concrete closure structure can be serious if foundation conditions are poor and the juncture is improperly designed. Preloading has been used successfully to minimize differential settlements at these locations. In EM 1110-2-2502 a transitioning procedure for a junction between a levee embankment and a floodwall is presented that minimizes the effect of differential settlement.

b. Compaction. Thorough compaction of the levee embankment at the junction of the concrete structure and levee is essential. Good compaction decreases the permeability of the embankment material and ensures a firm contact with the structure. Heavy compaction equipment such as pneumatic or sheepfoot rollers should be used where possible. In confined areas such as those immediately adjacent to concrete walls, compaction should be by hand tampers in thin loose lifts as described in EM 1110-2-1911.

c. Seepage. Seepage needs to be analyzed to determine the embedment length of the structure-levee junction. Zoning of the embankment materials needs to be maintained through the junction unless analysis indicates different zoning is required.

d. Slope protection. Slope protection should be considered for the levee embankment at all junctions of levees with concrete closure structures. Turbulence may result at the junction due to changes in the geometry between the levee and the structure. This turbulence will cause scouring of the levee embankment if slope protection is not provided. Slope protection for areas where scouring is anticipated is discussed in paragraph 7-6.

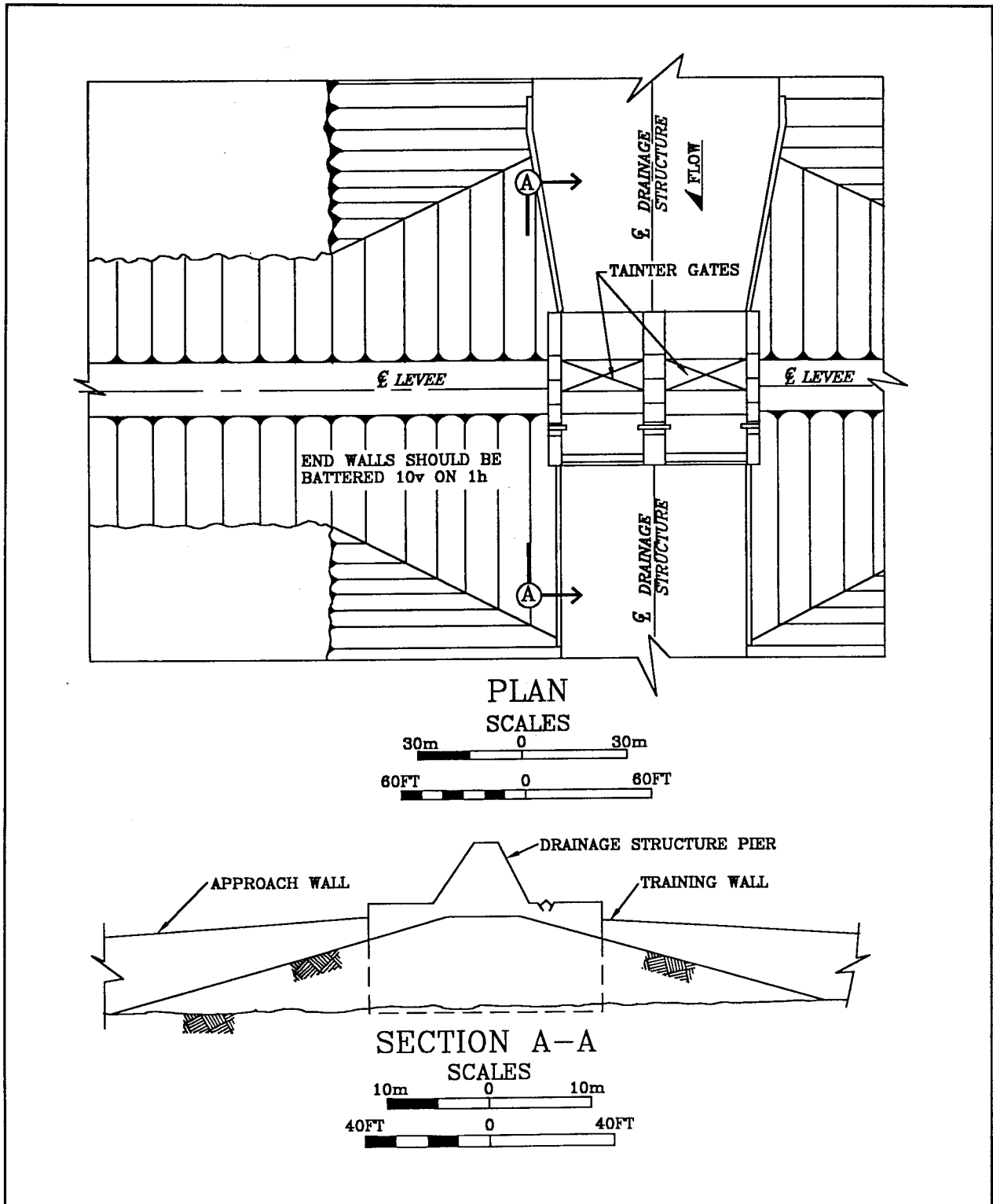

Figure 8-9. Junction of levee and drainage structure

Section V
Other Special Features

8-16. Construction of Ditches Landside of Levee

Sometimes requests are made to locate irrigation and/or drainage ditches in close proximity to the landside levee toe. Such ditches may lead to serious seepage and/or slope stability problems. The location and depth of proposed ditches should be established by seepage and stability analyses. This requires information on foundation soil conditions, river stages and geometry of the proposed ditch.

Drainage ditches should be located such that the exit gradient in the bottom of the ditch does not exceed 0.5 at the landside levee toe and does not exceed 0.8 at a distance 45.72 m (150 ft) landward of the landside levee toe and beyond. Between the landside levee toe and 45.72 m (150 ft) landward of the landside levee toe, the maximum allowable exit gradient in the bottom of the ditch should increase linearly from 0.5 to 0.8. The exit gradient should be computed assuming the water level in the ditch is at the bottom of the ditch.

8-17. Levee Vegetation Management

To protect or enhance esthetic values and natural resources, vegetation on a levee and its surrounding areas (trees, bushes and grasses) is an important part of design considerations. Vegetation can be incorporated in the project as long as it will not diminish the integrity and the functionality of the embankment system or impede ongoing operations, maintenance and floodfighting capability. A multidiscipline team including structural and geotechnical engineers, biologists and planners should evaluate the vegetation design or proposal. Coordination with local governments, states and Native American tribes may be needed during the design process. EM 1110-2-301 and ER 500-1-1 are two documents covering the vegetation policy applicable to both federal levees and non-federal levees under the PL-84-99 program.

Appendix A

References

A-1. Required Publications

TM 5-818-5

Dewatering and Groundwater Control for Deep Excavations

ER 500-1-1

Natural Disaster Procedures

ER 1110-2-1806

Earthquake Design and Evaluation for Civil Works Projects

EM 1110-2-301

Guidelines for Landscape Planting at Floodwalls, Levees, and Embankment Dams

EM 1110-2-1601

Hydraulic Design of Flood Control Channels

EM 1110-2-1614

Design of Coastal Revetments, Seawall, and Bulkheads

EM 1110-1-1802

Geophysical Explorations for Engineering and Environmental Investigations

EM 1110-2-1901

Seepage Analysis and Control for Dams

EM 1110-1-1904

Settlement Analysis

EM 1110-1-1906

Soils Sampling

EM 1110-2-1902

Stability of Earth and Rock-Fill Dams

EM 1110-2-1913
30 Apr 2000

EM 1110-2-1906

Laboratory Soils Testing

EM 1110-2-1908

Instrumentation of Embankment Dams and Levees

EM 1110-2-1911

Construction Control for Earth and Rock-Fill Dams

EM 1110-2-1914

Design, Construction, and Maintenance of Relief Wells

EM 1110-2-2300

Earth and Rock-Fill Dams General Design and Construction Considerations

EM 1110-2-2502

Retaining and Flood Walls

EM 1110-2-2902

Conduits, Culverts, and Pipes

Federal Specification WW-P-405B(1)

Corrugated Steel Pipe

U.S. Army Engineer Waterways Experiment Station, CE, "Soil Mechanics Design, Stability of Slopes and Foundations," Technical Memorandum No. 3-777, Feb 1952, P.O. Box 631, Vicksburg, Miss. 39180

U.S. Army Engineer Waterways Experiment Station, CE, "Underseepage and Its Control, Lower Mississippi River Levees," Technical Memorandum No. 3-424, Vol I, Oct 1956, P.O. Box 631, Vicksburg, Miss. 39180

U.S. Army Engineer Division, Lower Mississippi Valley, CE, "Design Procedures for Design of Landside Seepage Berms for Mississippi River Levees," P.O. Box 80, Vicksburg, Miss. 39180

U.S. Army Engineer District, Rock Island, CE, "Engineering and Design Studies for Underseepage Control (Slurry Trench Cutoff) for Saylorville Dam, Des Moines River, Iowa," Design Memorandum, Nov 1965, Clock Tower Bldg., Rock Island, Ill. 61201

U.S. Army Engineer District, Savannah, CE, "West Point Project, Chatahoochee River, Alabama and Georgia, Construction of Slurry Trench Cutoff," May 1968, P.O. Box 889, Savannah, Ga., 31402

Tuck and Torrey 1993

Tuck, G. F. and Torrey, V. H., III, Upper Mississippi River Basin Flood of 1993 Flood-Fight Reconnaissance and Survey of Expedient Methods Employed, December 1993, U.S. Army Engineer Waterways Experiment Station, 3909 Halls Ferry Road, Vicksburg, MS 39180-6199

NAVFAC, Soil Mechanics Foundations and Earth Structures, Design Manual 7, Mar 1971. U.S. Naval Publications and Forms Center, 5801 Tabor Avenue, Philadelphia, Pennsylvania 19120

A-2. Related Publications

Bennett, Guice, Khan, and Staheli 1995

Bennett, R. D., Guice, L. K., Khan, S., and Staheli, K., 1995, "Guidelines for Trenchless Technology: Cured-in Place Pipe (CIPP), Fold and Formed Pipe (FFP) Mini-Horizontal Directional Drilling (mini-HDD) Microtunneling," Construction Productivity Advancement Research (CPAR) Program, GL-95-2, U.S. Army Engineer Waterways Experiment Station, Vicksburg, MS.

Bhowmik 1994

Bhowmik, N. G., et al., The 1993 Flood on the Mississippi River in Illinois, January 1994, Illinois State Water Survey Miscellaneous Publication 151, 2204 Griffith Drive, Champaign, IL 61820

Biedenharn and Tracy 1987

Biedenharn, D. G., and Tracy, F. T., 1987, "Finite Element Method Package for Solving Steady-State Seepage Problems," Technical Report ITL-87-6, U.S. Army Engineer Waterways Experiment Station, Vicksburg, MS

Bjerrum 1972

Bjerrum, L., "Embankments on Soft Ground," Proceedings, Specialty Conference on Performance of Earth and Earth-Supported Structures, Vol II, 11-14 June 1972. ASCE, 345 East 47th St., New York, New York 10017

Blasters' 1966

Blasters' Handbook, 15th ed., E. I. Dupont de Nemours and Co., Inc., 1966, Wilmington, Delaware 19898

Brizendine, Taylor, and Gabr 1995

Brizendine, A. L., Taylor, H. M., Jr., and Gabr, M. A., 1995. "LEVSEEP: Analysis Software for Levee Underseepage and Rehabilitation," Technical Report GL-95-10, U.S. Army Engineer Waterways Experiment Station, Vicksburg, MS

Butler and Llopis

Butler, Dwain K., and Llopis, Jose L., "Assessment of Anomalous Seepage Conditions," Geotechnical and Environmental Geophysics, Vol. II, pp. 153-173, Environmental and Groundwater, Society of Exploration Geophysicists, P.O. Box 702740, Tulsa, OK 74170-2740.

Dobrin 1960

Dobrin, M. B., Geophysical Prospecting, 1960, McGraw Hill Publishing Co., 1221 Avenue of The Americas, New York, New York, 10020

Engineering Computer Graphics Laboratory 1996

Engineering Computer Graphics Laboratory, 1996, "FastSEEP Automated Seepage Analysis Reference Manual," Brigham Young University, Provo, UT

Gabr, Brizendine, and Taylor 1995

Gabr, M. A., Brizendine, A. L., and Taylor, H. M., Jr., 1995, "Comparison Between Finite Element Study and Simplified Analysis of Levee Underseepage," Technical Report GL-95-11, U.S. Army Engineer Waterways Experiment Station, Vicksburg, MS

Gabr, Taylor, Brizendine, and Wolff 1995

Gabr, M. A., Taylor, H. M., Jr., Brizendine, A. L., and Wolff, T. F., 1995, "LEVEEMSU: Analysis Software for Levee Underseepage and Rehabilitation," Technical Report GL-95-9, U.S. Army Engineer Waterways Experiment Station, Vicksburg, MS

General Accounting Office 1995

General Accounting Office, Midwest Flood: Information on the Performance, Effects, and Control of Levees, August 1995, GAO/RCED-95-125, Resources, Community, and Economic Development Division, P.O. Box 6015, Gaithersburg, MD 20884-6015

Interagency Floodplain Management Review Committee 1994

Interagency Floodplain Management Review Committee, Sharing the Challenge: Floodplain Management Into the 21st Century, June 1994, Report to the Administration Floodplain Management Task Force, Government Printing Office, Superintendent of Documents, P.O. Box 371954, Pittsburgh, PA 15250-7954

Johnson 1970

Johnson, S. J., "Foundation Precompression with Vertical Sand Drains," Journal, Soil Mechanics and Foundations Division, American Society of Civil Engineers, Jan 1970, ASCE, 345 East 47th St., New York, New York 10017

Kapp, York, Aronowitz, and Sitomer 1966

Kapp, M. S., York, D. L., Aronowitz, A., and Sitomer, H., "Construction on Marshland Deposits: Treatment and Results," Utilization of Sites of Soft Foundations Highway Research Record No. 133, pp 1-22, 1966, Transportation Research Board, 2101 Constitution Avenue, N. W., Washington, D. C. 20418

Knowles 1992

Knowles, V. R., 1992, "Applications of the Finite Element Seepage Analysis Corps Program CSEEP (X8202)," Technical Report ITL-92-6, U.S. Army Engineer Waterways Experiment Station, Vicksburg, MS

Ladd and Foott 1974

Ladd, Charles C., and Foott, Roger, 1974, "New Design Procedure for Stability of Soft Clays, Vol. 100 No. GT7, Journal of the Geotechnical Engineering Division.

Sherard 1979

Sherard, J. L., 1979, "Sinkholes in Dams of Coarse, Broadly Graded Soils," Transaction of the 13th International Congress on Large Dams, New Delhi, India, Vol. 11, pp 25-35.

Staheli, Bennett, O'Donnell, and Hurley 1998

Staheli, K., Bennett, D., O'Donnell, H. W., and Hurley, T. J., 1998, "Installation of Pipelines Beneath Levees Using Horizontal Directional Drilling," Construction Productivity Advancement Research (CPAR) Program, GL-98-1, U.S. Army Engineer Waterways Experiment Station, Vicksburg, MS.

Telford, Geldart, Sheriff, and Keys 1990

Telford, W. M., Geldart, L. P., Sheriff, R. E., and Keys, D. A., 1990, "Applied Geophysics," Cambridge University Press, New York.

Tobin 1995

Tobin, G. A., "The Levee Love Affair: A Stormy Relationship," Water Resources Bulletin, Vol 31, No. 3, 1995, American Water Resources Association, 950 Herndon Parkway, Herndon, VA 22070-5531

Tracy 1994

Tracy, F. T., 1994, "Seepage Package," CSEEP Micro Version, X8202, U.S. Army Engineer Waterways Experiment Station, Vicksburg, MS

Turnbull and Mansur 1959

Turnbull, W. J. and Mansur, C. I., "Design of Underseepage Control Measures for Dams and Levees," Journal, Soil Mechanics and Foundations Division, American Society of Civil Engineers, Oct. 1959, ASCE, 345 East 47th St., New York, New York 10017

Turnbull and Mansur 1959

Turnbull, W. J. and Mansur, C. I., "Construction and Maintenance of Underseepage Control Measures," Journal, Soil Mechanics and Foundations Division, American Society of Civil Engineers, Dec. 1959, ASCE, 345 East 47th St., New York, New York 10017

Wolff 1989

Wolff, T. F., 1989, "LEVEEMSU: A Software Package Designed for Levee Underseepage Analysis," Technical Report GL-89-13, U.S. Army Engineer Waterways Experiment Station, Vicksburg, MS

ASTM D 1056

American Society for Testing and Materials, 1916 Race Street, Philadelphia, Pennsylvania 19103

ASTM D 2573

American Society for Testing and Materials, 1916 Race Street, Philadelphia, Pennsylvania 19103.

AASHTO M 243-73

American Association of State Highway and Transportation Officials, 341 National Press Bldg., Washington, DC. 20004

Appendix B

Mathematical Analysis of Underseepage and Substratum Pressure

B-1. General

The design of seepage control measures for levees often requires an underseepage analysis without the use of piezometric data and seepage measurements. Contained within this appendix are equations by which an estimate of seepage flow and substratum pressures can be made, provided soil conditions at the site are reasonably well defined. The equations contained herein were developed during a study (reported in U.S. Army Engineer Waterways Experiment Station TM 3-424 (Appendix A) of piezometric data and seepage measurements along the Lower Mississippi River and confirmed by model studies. It should be emphasized that the accuracy obtained from the use of equations is dependent upon the applicability of the equation to the condition being analyzed, the uniformity of soil conditions, and evaluation of the various factors involved. As is normally the case, sound engineering judgment must be exercised in determining soil profiles and soil input parameters for these analyses.

B-2. Assumptions

It is necessary to make certain simplifying assumptions before making any theoretical seepage analysis. The following is a list of such assumptions and criteria necessary to the analysis set forth in this appendix.

- a.* Seepage may enter the pervious substratum at any point in the foreshore (usually at riverside borrow pits) and/or through the riverside top stratum.
- b.* Flow through the top stratum is vertical.
- c.* Flow through the pervious substratum is horizontal.
- d.* The levee (including impervious or thick berms) and the portion of the top stratum beneath it is impervious.
- e.* All seepage is laminar.

In addition to the above, it is also required that the foundation be generalized into a pervious sand or gravel stratum with a uniform thickness and permeability and a semipervious or impervious top stratum with a uniform thickness and permeability (although the thickness and permeability of the riverside and landside top stratum may be different).

B-3. Factors Involved in Seepage Analyses

The volume of seepage (Q_s) that will pass beneath a levee and the artesian pressure that can develop under and landward of a levee during a sustained high water are related to the basic factors given and defined in Table B-1 and shown graphically in Figure B-1. Other values used in the analyses are defined as they are discussed in subsequent paragraphs.

B-4. Determination of Factors Involved in Seepage Analyses

Table B-2 contains a brief summary of methods normally used to determine the factors necessary to perform a seepage analysis. The determination of these factors is discussed in more detail in the following paragraphs. Many of the methods given, such as exploration and testing, have previously been mentioned in the text; however, they will be discussed herein in more detail as they apply to each specific factor. The use of piezometric data, although rarely available on new projects, is mentioned primarily because it is not infrequent for seepage analyses to be performed as a part of remedial measures to existing levees in which case piezometric data often are available.

Table B-1
Factors Involved in Seepage Analyses

Factor	Definition
H	Net head on levee
M	Slope of hydraulic grade line (at middepth of pervious stratum) beneath levee
i_c	Critical gradient for landside top stratum
L_1	Distance from river to riverside levee toe
L_2	Base width of levee and berm
L_3	Length of foundation and top stratum beyond landside levee toe
L	Distance from effective seepage entry to effective seepage exit
s	Distance from effective seepage entry to landside toe of levee or berm
X_1	Distance from effective seepage entry to riverside levee toe
X_3	Distance from landside levee toe to effective seepage exit
d	Thickness of pervious substratum
z	Thickness of top stratum
z_b	Transformed thickness of top stratum
z_{bl}	Transformed thickness of landside top stratum
z_{br}	Transformed thickness of riverside top stratum
z_n	Thickness of individual layers comprising top stratum (n = layer number)
z_l	Transformed thickness of landside top stratum for uplift computation
k_b	Vertical permeability of top stratum
k_{bl}	Vertical permeability of landside top stratum
k_{br}	Vertical permeability of riverside top stratum
k_f	Horizontal permeability of pervious substratum
k_n	Vertical permeability of individual layers comprising top stratum (n = layer number)
Q_s	Total amount of seepage passing beneath the levee
h_o	Head beneath top stratum at landside levee toe
h_x	Head beneath top stratum at distance x from landside levee toe

Table B-2
Methods for Determination of Design Parameters

Factor	Method of Determination
H	From design flood stage or net levee grade
k_{bl} , k_{br}	From laboratory tests, estimations, and transformations
k_f	Field pump tests, correlations
z_b	Foundation exploration, knowledge of depth and locations of borrow pits, ditches, etc.
z_{bl} , z_{br}	From transformations
d	Foundation exploration
i_c	From equation B-9
M	From piezometers or from determining effective entrance and exit points of seepage
L_1	From maps
L_2	From preliminary or existing levee section
L_3	From foundation exploration and knowledge of location of levee
s	From piezometric data or estimated from equations
x_1	From knowing M or from equation B-7 or B-8
x_3	From knowing M or from equation B-3, B-3A, B-4, B-5, or B-6
Q_s	From equation B-11 or B-12
h_o	From piezometric data or estimated from equations
h_x	From piezometric data or estimated from equations

a. *Net head, H.* The net head on a levee is the height of water on the riverside above the tailwater or natural ground surface on the landside of the levee. H is usually based on the design or project flood stage but is sometimes based on the net levee grade.

b. *Thickness, z and vertical permeability, k_b , of top stratum.*

(1) *Exploration.* The thickness of the top stratum, both riverward and landward of the levee, is extremely important in a seepage analysis. Exploration to determine this thickness usually consists of auger borings with samples taken at 0.91- to 1.52-m (3- to 5-ft) intervals and at every change of material. Boring spacing will depend on the potential severity of the underseepage problem but should be laid out so as to sample the basic geologic features with intermediate borings for check purposes. Landside borings should be sufficient to delineate any significant geological features as far as 152.4 m (500 ft) away from the levee toe. The effect of ditches and borrow areas must be considered.

(2) *Transformation.* The top stratum in most areas is seldom composed of one uniform material but rather usually consists of several layers of different soils. If the in situ vertical permeability of each soil (k_n) is known, it is possible to transform an overall effective thickness and permeability. However, if good judgment is exercised in selection of these values, a reasonably accurate seepage analysis can be made by using a simplified procedure. Basically this procedure consists of assuming a uniform vertical permeability

for the generalized top stratum equal to the permeability of the most impervious strata and then using the transformation factor given in equation B-1 to determine a corresponding thickness for the entire top stratum.

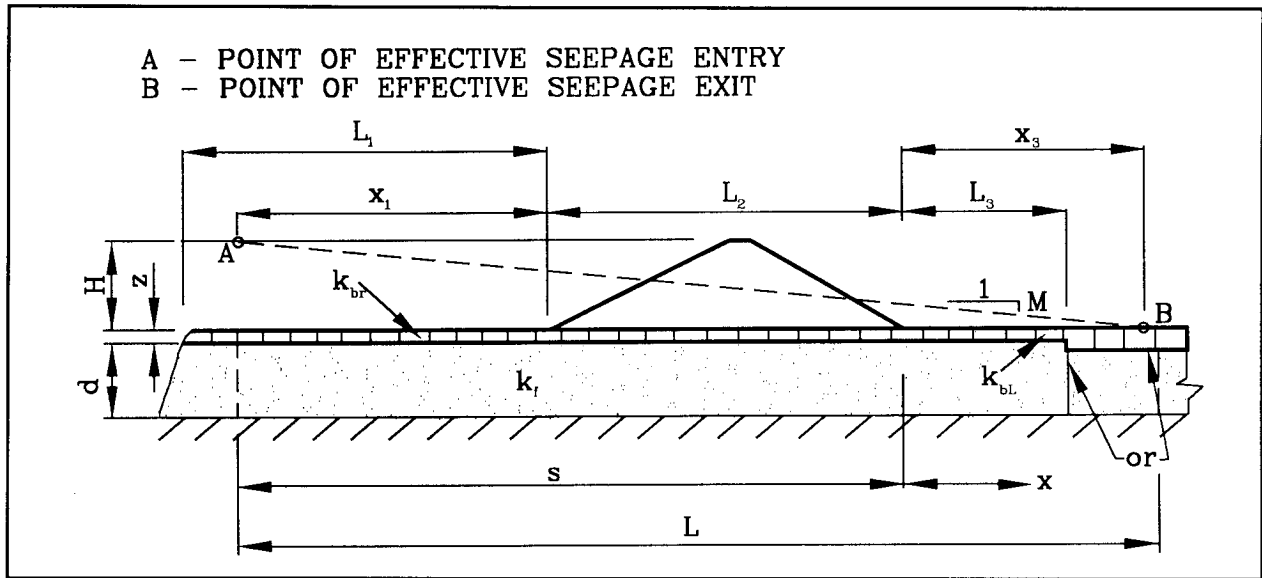

Figure B-1. Illustration of symbols used in Appendix B

$$F_t = \frac{k_b}{k_n} \quad (B-1)$$

where F_t = transformation factor.

If the in situ thickness of each soil layer (z_n) is known, the value of corresponding transformed thickness (z_t) can be expressed as

$$z_t = z_n F_t = z_n \frac{k_b}{k_n} \quad (B-1a)$$

The total in situ thickness (z) and total transformed can be expressed as

$$z = \sum_1^n z_n \quad (B-1b)$$

$$z_b = \sum_1^n z_t \quad (B-1c)$$

Some examples using this procedure are given in Table B-3 and in Figure B-2.

Table B-3
Examples of Transformation Procedure

Strata	Actual Thickness z_i , m (ft)	Actual Permeability cm/sec	$F_i = \frac{K_b}{K_i}$	Transformed Thickness, z_i , m (ft) ($k_b = 1 \times 10^{-4}$ cm/sec)
Clay	1.52 (5)	1×10^{-4}	1	1.52 (5.0)
Sandy silt	2.44 (8)	2×10^{-4}	1/2	1.22 (4.0)
Silty sand	<u>1.52 (5)</u>	10×10^{-4}	1/10	<u>0.15 (0.5)</u>
	$z = 5.48$ (18)			$z_b = 2.90$ (9.5)

A generalized top stratum having a uniform permeability of 1×10^{-4} cm/sec and 2.9 m (9.5 ft) thick would then be used in the seepage analysis for computation of the length to the effective seepage exit. However, the thickness z_b may or may not be the effective thickness of the landside top stratum z_i that should be used in determining the allowable pressure beneath the top stratum. The transformed thickness of the top stratum for estimating allowable uplift z_i equals the in situ thicknesses of all strata above the base of the least pervious stratum plus the transformed thicknesses of the underlying more pervious top strata. This means that z_b will equal z_i only when the least pervious stratum is at the ground surface. Several examples of this transformation are given in Figure B-2. In making the final determination of the effective thicknesses and permeabilities of the top stratum, the characteristics of the top stratum at least 61 to 91.4 m (200 to 300 ft) landward of the levee must be considered. In addition, certain averaging assumptions are almost always required where soil conditions are reasonably similar. Thin or critical areas should be given considerable weight in arriving at such averages.

c. Thickness d and permeability k_f of pervious substratum. The thickness of the pervious substratum is defined as the thickness of the principal seepage-carrying stratum below the top stratum and above rock or other impervious base stratum. It is usually determined by means of deep borings although a combination of shallow borings and seismic or electrical resistivity surveys may also be employed. The thickness of any individual pervious strata within the principal seepage carrying stratum must be obtained by deep borings. The average horizontal permeability k_f of the pervious substratum can be determined by means of a field pump test on a fully penetrating well or by the use of correlations as shown in Figure 3-5(b) in the main text. For areas where such correlations exist their use will usually result in a more accurate permeability determination than that from laboratory permeability tests. In addition to the methods above, if the total amount of seepage per unit length passing beneath the levee (Q_s), the hydraulic grade line beneath the levee (M) and the thickness of pervious stratum (d) are known, k_f can be estimated from

$$k_f = \frac{Q_s}{M \cdot d} \quad (\text{B-2})$$

d. Distance from riverside levee toe to river, L_1 . This distance can usually be estimated from topographic and stratigraphic maps.

e. Base width of levee and berm, L_2 . L_2 can be determined from anticipated dimensions of new levees or by measurement in the case of existing levees.

f. Length of top stratum landward of levee toe, L_3 . This distance can usually be determined from borings, topographic maps, and/or field reconnaissance. In determining this distance careful consideration

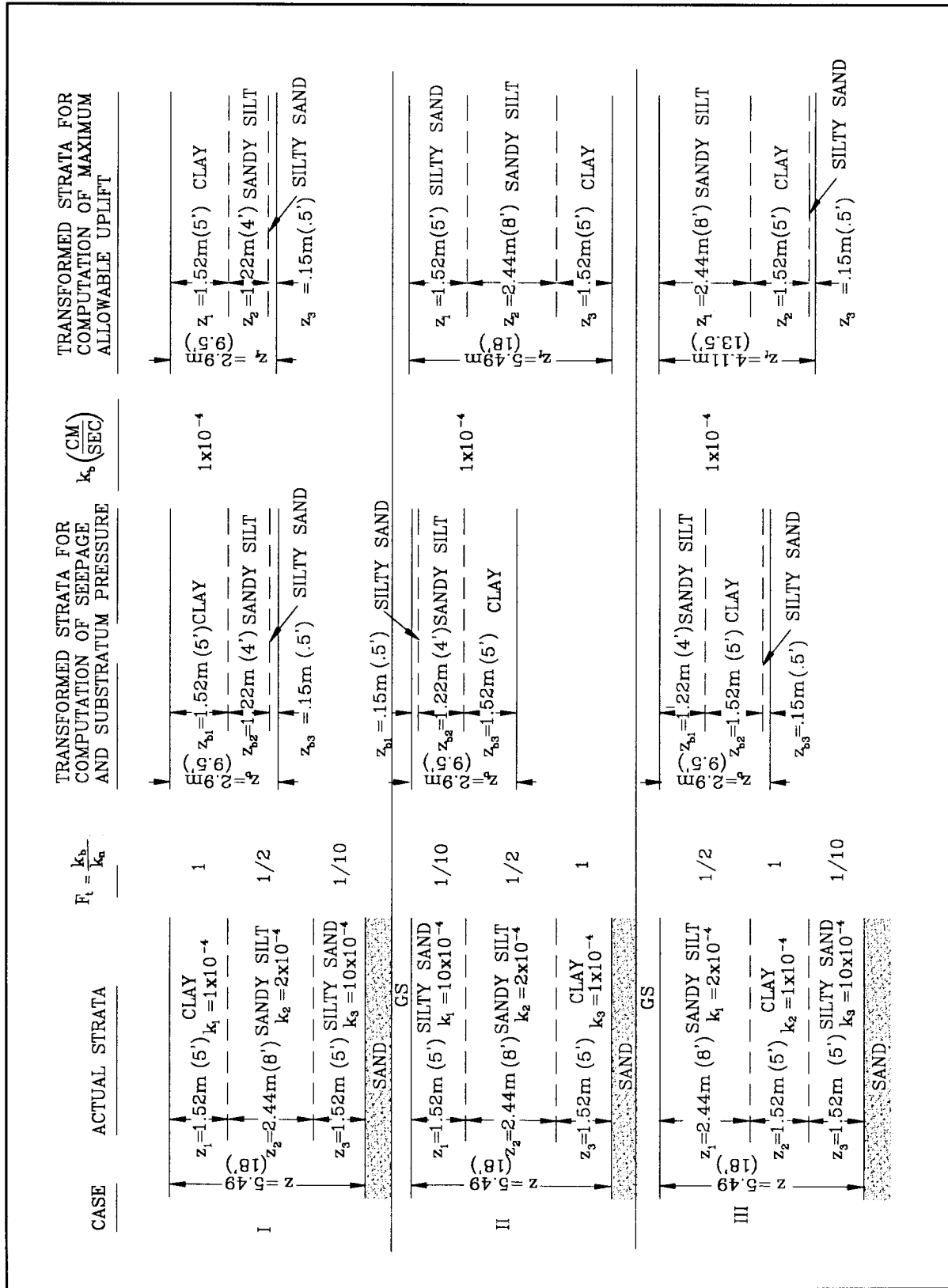

Figure B-2. Transformation of top strata

must be given to any geological feature that may affect the seepage analysis. Of special importance are deposits of impervious materials such as clay plugs which can serve as seepage barriers and if located near the landside toe could force the emergence of seepage at their near edge, thus having a pronounced effect on the seepage analysis.

g. *Distance from landside levee toe to effective seepage exit, x_3 .* The effective seepage exit (point B, Figure B-1) is defined as that point where a hypothetical open drainage face would result in the same hydrostatic pressure at the landside levee toe and would cause the same amount of seepage to pass beneath the levee as would occur for actual conditions. This point is also defined as the point where the hydraulic grade line beneath the levee projected landward with a slope M intersects the groundwater or tailwater. If the length of foundation and top stratum beyond the landside levee toe L_3 is known, x_3 can be estimated from the following equations:

(1) For $L_3 = \infty$

$$x_3 = \frac{1}{c} = \sqrt{\frac{k_f z_{bl} d}{k_{bl}}} \quad (\text{B-3})$$

where

$$c = \sqrt{\frac{k_{bl}}{k_f z_{bl} d}} \quad (\text{B-3A})$$

(2) For $L_3 =$ finite distance to a seepage block

$$x_3 = \frac{1}{c \tanh (cL_3)} \quad (\text{B-4})$$

(3) For $L_3 =$ finite distance to an open seepage exit

$$x_3 = \frac{\tanh (cL_3)}{c} \quad (\text{B-5})$$

(4) The relationship between z_{bl} and x_3 where L_3 is infinite in landward extent has been computed from equation B-3 and plotted in Figure B-3 for various values of k_f/k_{bl} and assuming $d = 100$ m or 100 ft. The x_3 value corresponding to values of d other than 100 m or 100 ft can be computed from equation B-6 below:

$$x_3 = (0.1 \sqrt{d}) x_3' \quad (\text{B-6})$$

where

x_3' is the value of x_3 for $d = 100$ m or 100 ft

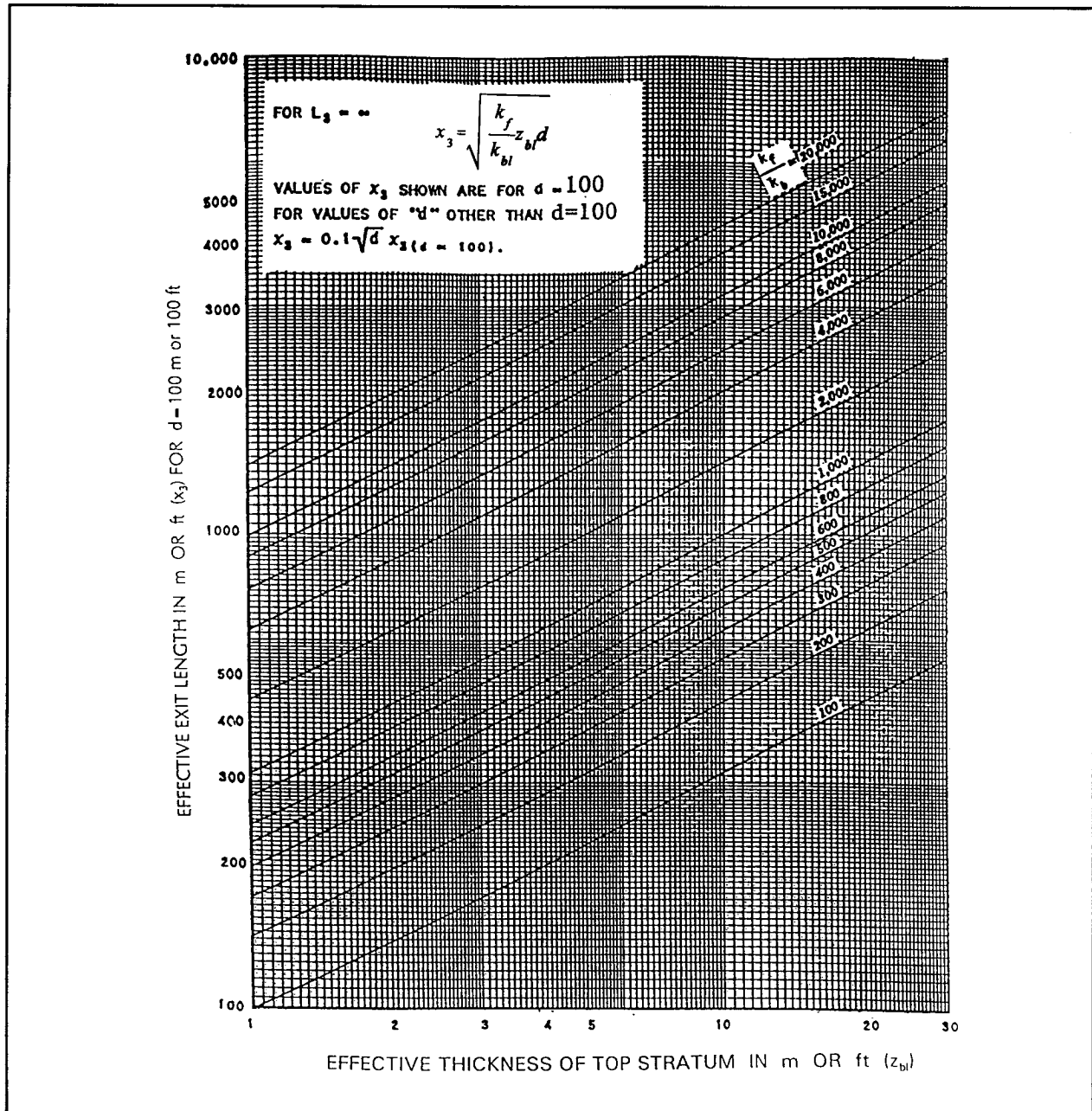

Figure B-3. Effective seepage exit length for $L_3 = \infty$ and $d = 100$ m or ft

Example: Using Figure B-3, find x_3 for soil with $\frac{k_f}{k_{bl}} = 200$, $z_{bl} = 3.05$ m (10 ft), and $d = 45.7$ m (150 ft)

Solution: 1 - From Figure B-3 the value x_3 for $\frac{k_f}{k_{bl}} = 200$, $z_{bl} = 3.05$ m (10 ft). Then for $z_{bl} = 3.05$ m and $d = 100$ m, $x_3' = 246$ m; or $z_{bl} = 10$ ft and $d = 100$ ft, $x_3' = 450$ ft

2 - Apply Equation B-6 to determine x_3 for $d = 45.7$ m (150 ft)

$$x_3 = 0.1 \sqrt{45.7} x_3'$$

$$x_3 = (0.1)(6.76)(246) = 167 \text{ m}$$

or

$$x_3 = 0.1 \sqrt{d} (450) = 0.1 \sqrt{150} (450) = 551 \text{ ft}$$

(5) If L_3 is a finite distance either to a seepage block or an open seepage exit, the effective exit length x_3 can be computed by using equation B-4 or B-5 or by multiplying x_3 (for $L_3 = \infty$) by a factor obtained from Figure B-4.

h. Distance from effective source seepage entry to riverside levee toe, x_1 . The effective source of seepage entry into the pervious substratum (point A in Figure B-1) is defined as that line riverward of the levee where a hypothetical open seepage entry face fully penetrating the pervious substratum and with an impervious top stratum between this line and the levee would produce the same flow and hydrostatic pressure beneath and landward of the levee as will occur for the actual conditions riverward of the levee. It is also defined as that line or point where the hydraulic grade line beneath the levee projected riverward with a slope M intersects the river stage.

(1) If the distance to the river from the riverside levee toe L_1 is known and no riverside borrow pits or seepage blocks exist, x_1 can be estimated from the following equation:

$$x_1 = \frac{\tanh cL_1}{c} \quad (\text{B-7})$$

(2) If a seepage block (usually a wide, thick deposit of clay) exists between the riverside levee toe and the river so as to prevent any seepage entrance into the pervious foundation beyond that point, x_1 can be estimated from the following equation:

$$x_1 = \frac{1}{c \tanh cL_1} \quad (\text{B-8})$$

where L_1 equals distance from riverside levee toe to seepage block and c is from equation B-3A.

i. Critical gradient for landside top stratum, i_c . The critical gradient is defined as the gradient required to cause boils or heaving (flotation) of the landside top stratum and is taken as the ratio of the submerged or buoyant unit weight of soil \tilde{a}' comprising the top stratum and the unit weight of water \tilde{a}_w or

$$i_c = \frac{\tilde{a}'}{\tilde{a}_w} = \frac{G_s - 1}{1 + e} \quad (\text{B-9})$$

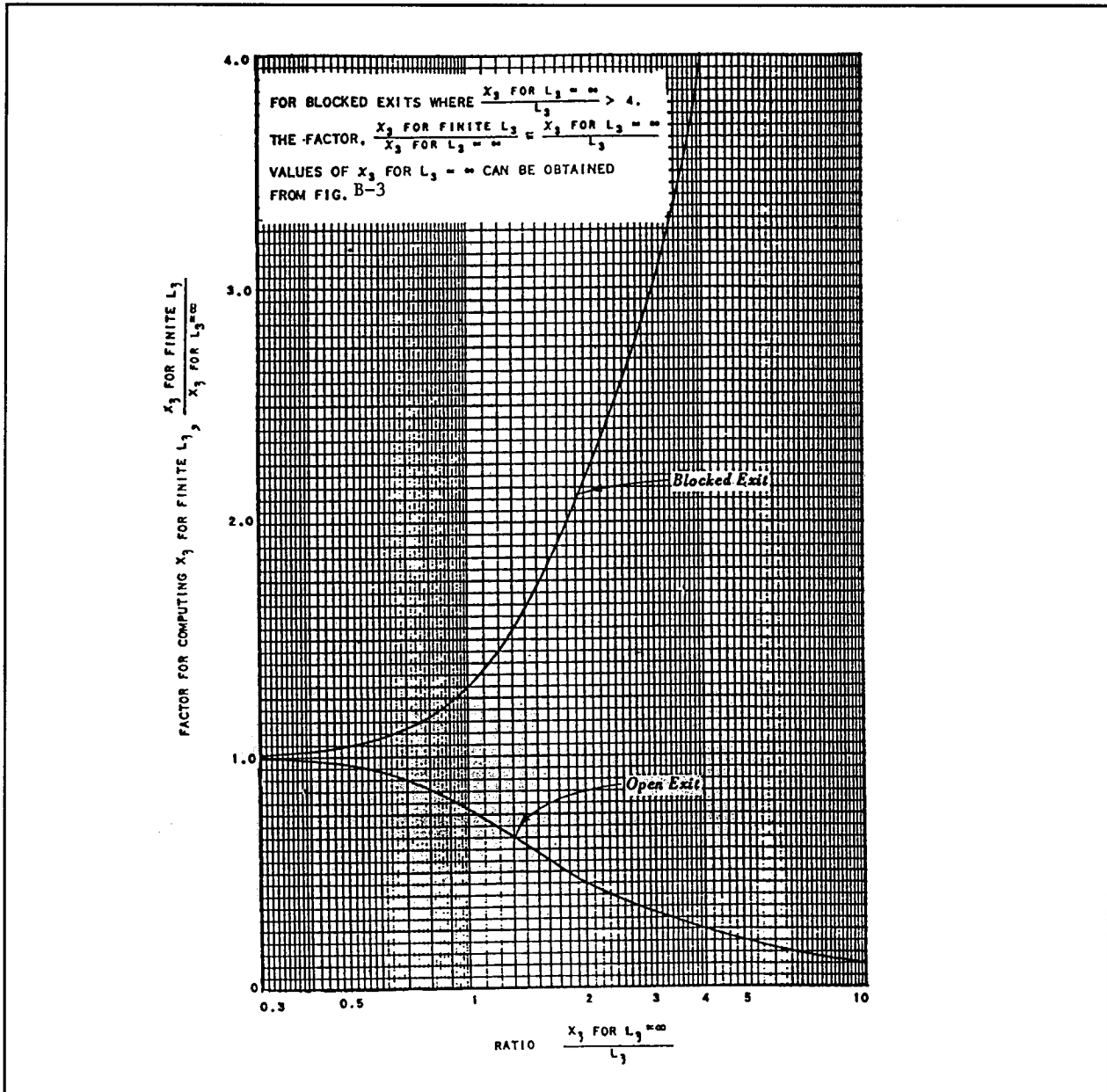

Figure B-4. Ratio between x_3 for blocked or open exits and x_3 for $L_3 = \infty$

where

G_s = specific gravity of soil solids
 e = void ratio

j. *Slope of hydraulic grade line beneath levee, M.* The slope of the hydraulic grade line in the pervious substratum beneath a levee can best be determined from readings of piezometers located beneath the levee where the seepage flow lines are essentially horizontal and the equipotential lines vertical. If such readings during high water are available, M can be determined from the following relation:

$$M = \frac{\ddot{A}h}{L} \quad (\text{B-10a})$$

where

$\ddot{A}h$ = the difference in piezometer readings
= the horizontal distance between piezometers

This relationship is not valid, however, until artesian flow conditions have developed beneath the levee. If no piezometer readings are available, as in the case for new levee design, M must be determined by exit points and first establishing the effective seepage entrance and then connecting these points with a straight line, the slope of which is M. For new levees M is expressed as

$$M = \frac{H}{x_1 + L_2 + x_3} \quad (\text{B-10b})$$

B-5. Computation of Seepage Flow and Substratum Hydrostatic Pressures

a. General

(1) Seepage. For a levee underlain by a pervious foundation, the natural seepage per unit length of levee, Q_s , can be expressed by the general equation B-11.

$$Q_s = \mathcal{S} k_f H \quad (\text{B-11})$$

where

\mathcal{S} = shape factor

This equation is valid provided the assumptions upon which Darcy's law is based are met. The mathematical expressions for the shape factor \mathcal{S} (subsequently given in this appendix) depend upon the dimensions of the generalized cross section of the levee and foundation, the characteristics of the top stratum both riverward and landward of the levee, and the pervious substratum. Where the hydraulic grade line M is known from piezometer readings, the quantity of underseepage per unit length of the levee can be determined from equation B-12 as

$$Q_s = M k_f d \quad (\text{B-12})$$

(2) Excess hydrostatic head beneath the landside top stratum.

(a) The excess hydrostatic head h_0 beneath the top stratum at the landside levee toe is related to the net head on the levee, the dimensions of the levee and foundation, permeability of the foundation, and the character of the top stratum both riverward and landward of the levee. The head h_0 can be expressed as a function of the net head H and the geometry of the piezometric line as subsequently shown.

(b) The head h_x beneath the top stratum at a distance x landward from the landside levee toe can be expressed as a function of the net head H and the distance x although it is more conveniently related to the head h_0 at the levee toe. When h_x is expressed in terms of h_0 it depends only upon the type and thickness of

the top stratum and pervious foundation landward of the levee; the ratio h_x/h_o is thus independent of riverward conditions.

(c) Expressions for \mathcal{S} , h_o , and h_x are discussed in the following paragraphs.

b. Various underseepage flow and top substratum conditions.

Case 1 - No Top Stratum. Where a levee is founded directly on pervious materials and no top stratum exists either riverward or landward of the levee (Figure B-5a), the seepage Q_s can be obtained from equation B-11 in which

$$\mathcal{S} = \frac{d}{L_2 + 0.86d} \quad (\text{B-13})$$

The excess hydrostatic head landward of the levee is zero and $h_o = h_x = 0$. The severity of such a condition in nature is governed by the exit gradient and seepage velocity that develop at the landside levee toe which can be estimated from a flow net compatible with the value of \mathcal{S} computed from Equation B-13. The maximum allowable exit gradient should be 0.5.

Case 2 - Impervious Top Stratum Both Riverside and Landside. This case is found in nature where the levee is founded on thick ($z_{bl} > 4.58$ m (15 ft)) deposits of clay or silts with clay strata. For such a condition little or no seepage can occur through the landside top stratum.

a. If the pervious substratum is blocked landward of the levee, no seepage occurs beneath the levee and $Q_s = 0$. The head beneath the levee and the landside top stratum is equal to the net head at all points so that $H = h_o = h_x$.

b. If the top stratum is impervious between the levee and river and has a length L_1 , and if an open seepage exit exists in the impervious top stratum at some distance L_3 from the landside toe (i.e., L_3 is not infinite as shown in Figure B-5b), the distance from the landside toe of the levee to the effective seepage entry (river, borrow pit, etc.) is $S = L_1 + L_2$ and

$$\mathcal{S} = \frac{d}{L_1 + L_2 + L_3} \quad (\text{B-14})$$

The heads h_o and h_x can be computed from

$$h_o = H \left(\frac{L_3}{L_1 + L_2 + L_3} \right) \quad (\text{B-15})$$

$$h_x = h_o \left(\frac{L_3 - x}{L_3} \right) \text{ for } x < L_3 \quad (\text{B-16})$$

$$h_x = 0 \text{ for } x > L_3$$

Case 3 - Impervious Riverside Top Stratum and No Landside Top Stratum. This condition may occur naturally or where extensive landside borrowing has taken place resulting in removal of all impervious material landward of the levee for a considerable distance. Seepage can be computed utilizing Equation B-11 and the following shape factor

$$s = \frac{d}{L_1 + L_2 + 0.43d} \quad (\text{B-17})$$

The excess head at the top of the sand landward of the levee is zero and the danger from piping must be evaluated from the upward gradient obtained from a flow net. This case is shown in Figure B-5c.

Case 4 - Impervious Landside Top Stratum and No Riverside Top Stratum. This is a more common case than Case 3, occurring when extensive riverside borrowing has resulted in removal of the riverside impervious top stratum (Figure B-5d). For this condition the seepage is computed from Equation B-11 utilizing the shape factor given in Equation B-18 below; the heads h_o and h_x can be computed from Equations B-19 and B-20, respectively.

$$s = \frac{d}{0.43d + L_2 + L_3} \quad (\text{B-18})$$

$$h_o = H \left(\frac{L_3}{0.43d + L_2 + L_3} \right) \quad (\text{B-19})$$

$$h_x = h_o \left(\frac{L_3 - x}{L_3} \right) \quad (\text{B-20})$$

Case 5 - Semipervious Riverside Top Stratum and No Landside Top Stratum. The same equation for the shape factor as was used in Case 3 can be applied to this condition provided x_1 is substituted for L_1 as follows:

$$s = \frac{d}{x_1 + L_2 + 0.43d} \quad (\text{B-21})$$

Since no landside top stratum exists, $h_o = h_x = 0$. This case is illustrated in Figure B-6a.

Case 6 - Semipervious Landside Top Stratum and No Riverside Top Stratum. The same equations for the shape factor and heads beneath the landside top stratum that are used for Case 4 are applicable to this case provided x_3 is substituted for L_3 (Figure B-6b). These equations are as follows:

$$s = \frac{d}{0.43d + L_2 + x_3} \quad (\text{B-22})$$

$$h_o = H \left(\frac{x_3}{0.43d + L_2 + x_3} \right) \quad (\text{B-23})$$

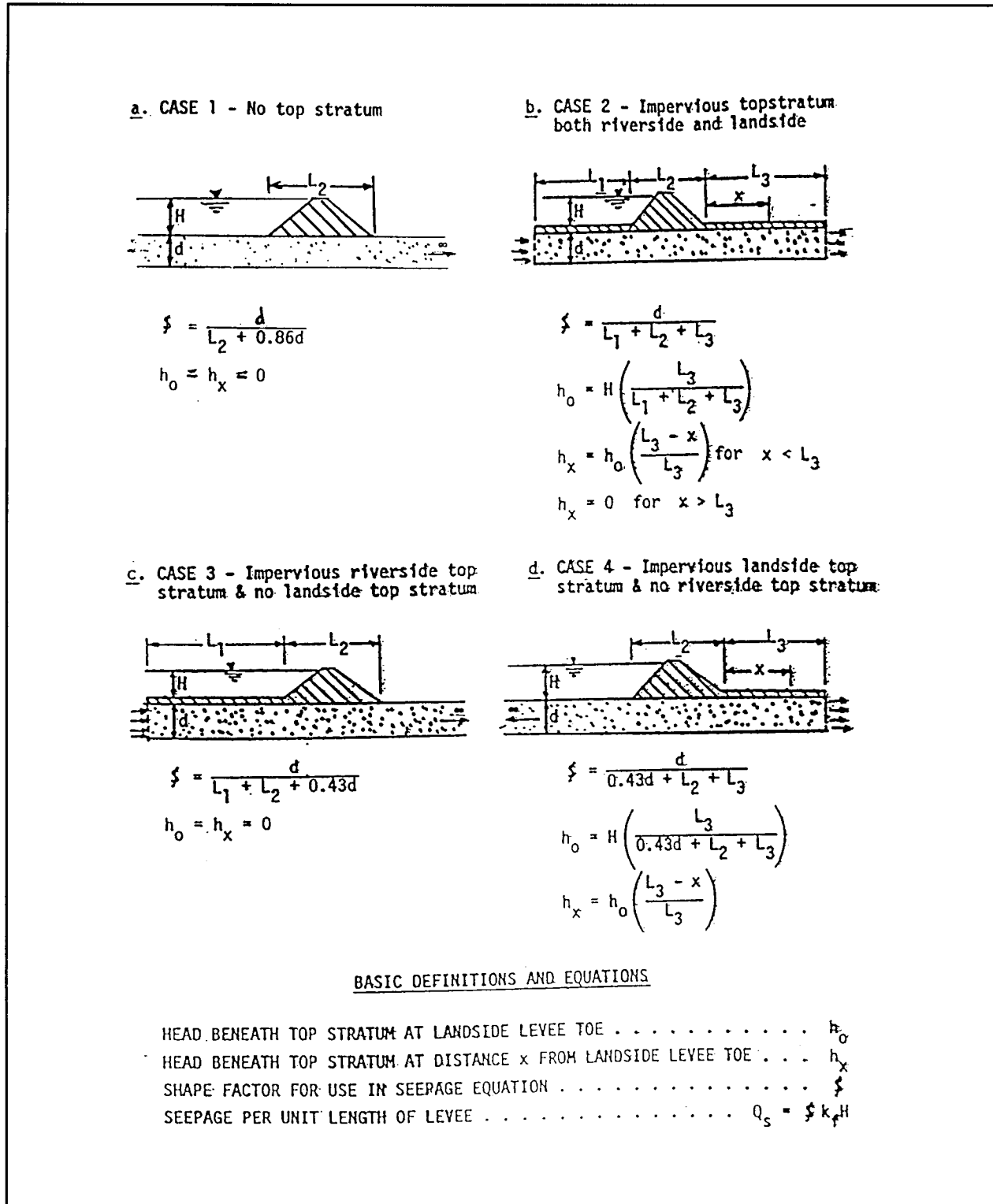

Figure B-5. Equations for computation of underseepage flow and substratum pressures for cases 1 through 4

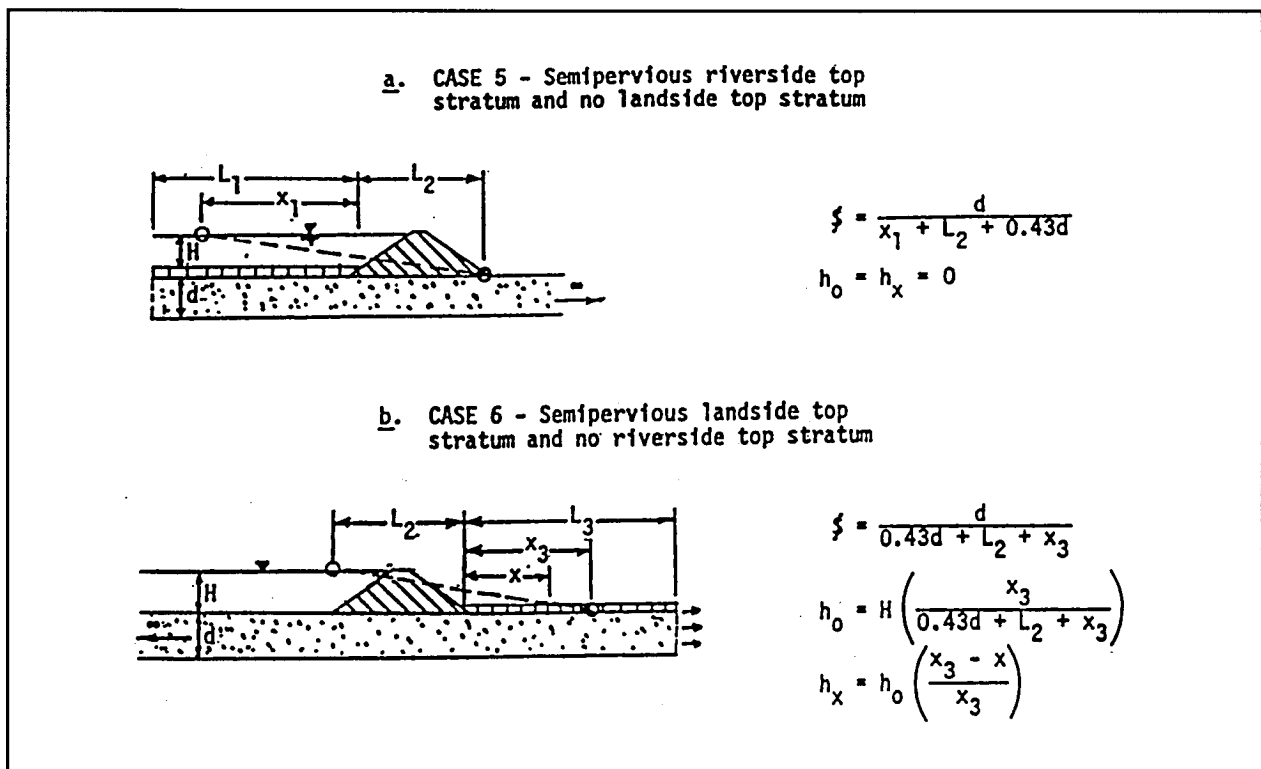

Figure B-6. Equations for computation of underseepage flow and substratum pressures for cases 5 and 6

$$h_x = h_o \left(\frac{x_3 - x}{x_3} \right) \quad (\text{B-24})$$

Case 7 - Semipervious Top Strata Both Riverside and Landside. Where both the riverside and landside top strata exist and are semipervious (Figure B-7), the quantity of underseepage can be computed from equation B-11 where \mathcal{S} is defined in Equation B-25.

$$\mathcal{S} = \frac{d}{x_1 + L_2 + x_3} \quad (\text{B-25})$$

The head beneath the top stratum at the landside toe of the levee is expressed by

$$h_o = H \left(\frac{x_3}{x_1 + L_2 + x_3} \right) \quad (\text{B-26})$$

The equations above are valid for all conditions where the landside top stratum is semipervious. However, the head h_x beneath the semipervious top stratum depends not only on the head h_o but also on conditions landward of the levee. Expressions are given below for typical conditions encountered landward of levees.

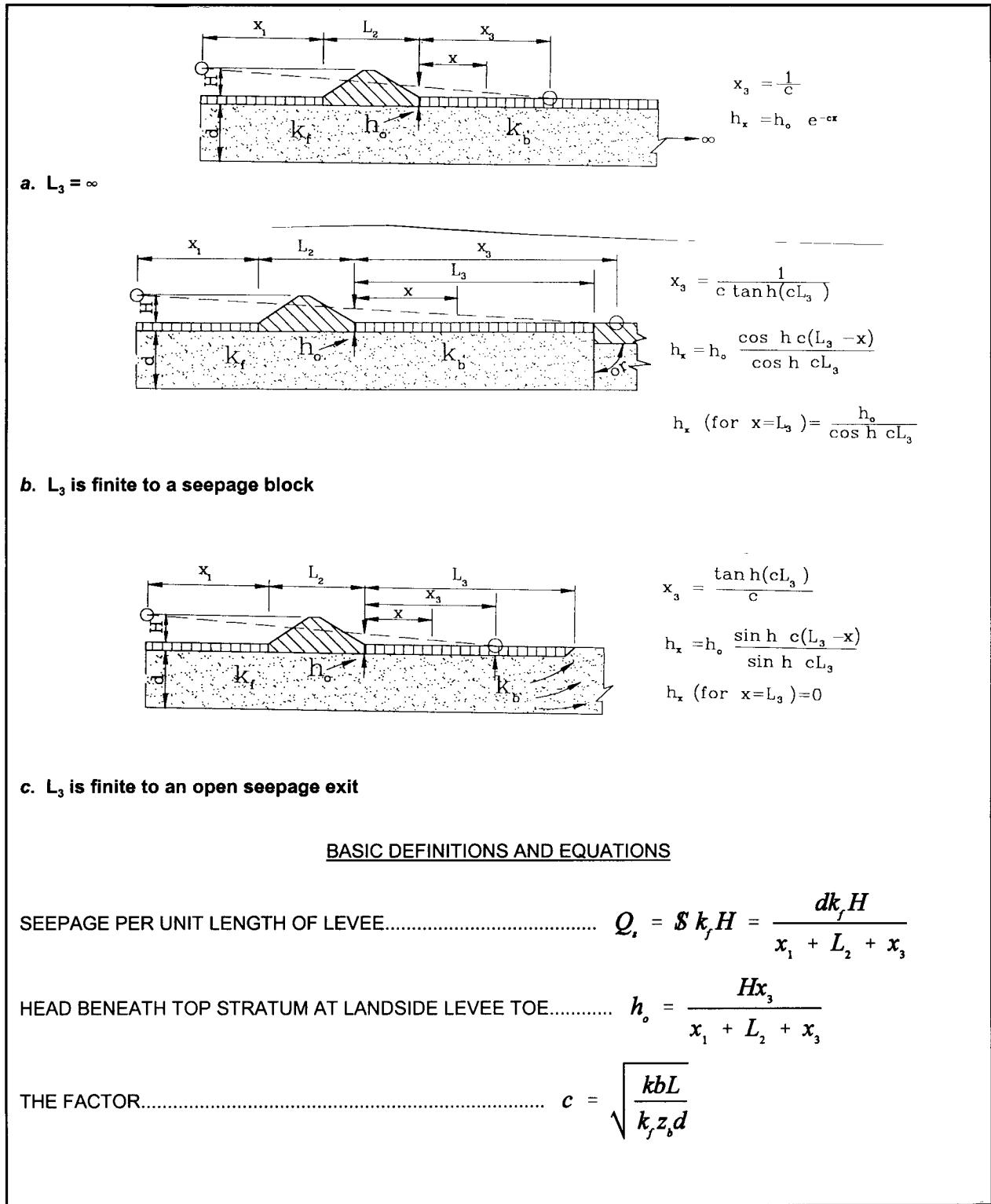

Figure B-7. Equations for computation of underseepage and substratum pressures for Case 7

(1) For $L_3 = \infty$

$$h_x = h_o e^{-cx} \quad (\text{B-27})$$

where

$$e = 2.718$$

(2) For $L_3 =$ a finite distance to a seepage block

$$h_x = h_o \frac{\cosh c(L_3 - x)}{\cosh cL_3} \quad (\text{B-28})$$

and

$$h_x \text{ (at } x = L_3) = \frac{h_o}{\cosh cL_3} \quad (\text{B-29})$$

(3) For $L_3 =$ a finite distance to an open seepage exit

$$h_x = h_o \frac{\sinh c(L_3 - x)}{\sinh cL_3} \quad (\text{B-30})$$

and

$$h_x \text{ (at } x = L_3) = 0 \quad (\text{B-31})$$

(4) Values of c and h_o in Equations B-27 through B-30 are as follows:

$$c = \sqrt{\frac{k_{bl}}{k_f z_{bl} d}}, \quad h_o = H \frac{x_3}{x_1 + L_2 + x_3} \quad (\text{B-32})$$

(5) In order to simplify the determination of h_x for various values of x , the relationship between h_x/h_o and x/x_3 is plotted in Figure B-8 for $L_3 = \infty$ and for various values of x_3/L_3 for both a seepage block and an open seepage exit. The procedure for determining h_x using Figure B-8 can be summarized as follows:

- a. Determine x_1 , L_2 , x_3 and the head h_o at the landside toe of the levee.
 - b. For the given distance x where h_x needs to be determined find the ratios x/x_3 and x_3/L_3 , then enter the appropriate graph in Figure B-8 to read the corresponding value of h_x/h_o .
 - c. Knowing the ratio h_x/h_o and the value of h_o compute h_x .
- (6) Values of h_o and h_x resulting from the equations above are actually hydrostatic heads at the middle of the pervious substratum; where the ratio k_f/k_b is less than 100 to 500, values of h_o and h_x immediately

beneath the top stratum will be slightly less than those computed because of the head loss resulting from upward seepage through the sand stratum.

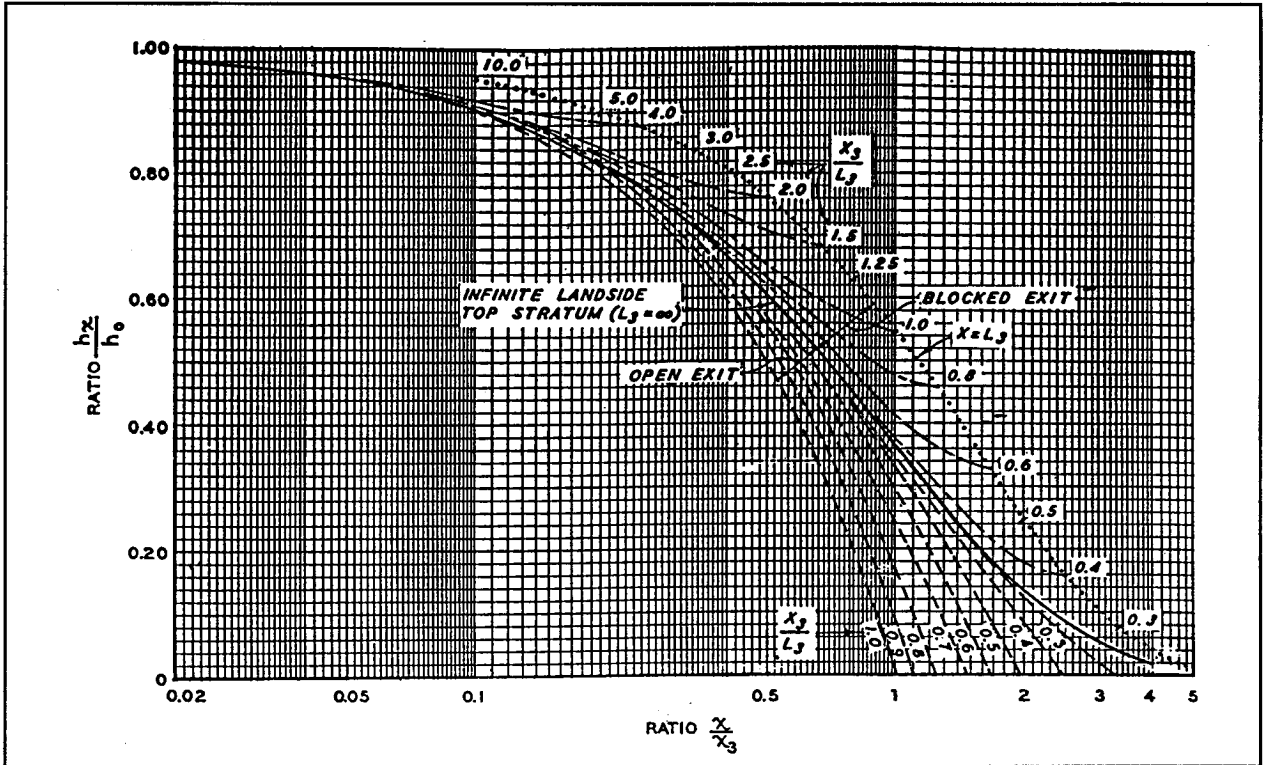

Figure B-8. Ratio between head landward of levee and head at landside toe of levee for levees founded on semipervious top stratum underlain by a pervious substratum

Appendix C Design of Seepage Berms

C-1. General

This appendix presents design factors, equations, criteria, and examples of designing landside seepage berms. A discussion of the four major types of landside seepage berms is presented in the main text of this manual. The design equations presented are taken from U.S. Army Engineer Waterways Experiment Station TM 3-424 and EM 1110-2-1901 (Appendix A). Design procedures are taken from TM 3-424 and from procedures developed by the Lower Mississippi Valley Division (Appendix A).

C-2. Design Factors

a. Seepage records, if available, should be studied to determine the severity of the underseepage conditions during high water. A projection based upon these records of underseepage during high water to the design flood should be made based on experience and judgment. Aerial photographs and borings should be used to evaluate geologic and soil conditions. The location of drainage ditches and borrow pits should be noted and considered in design. Additional borings should be made where required to determine in situ soil and geological data needed for design.

b. The distance s from the landside toe of the levee to the point of effective seepage entry is equal to the base width of the levee L_2 plus the effective length of blanket x_1 on the riverside of the levee. The effective length of blanket x_1 can be determined by using blanket equations presented in Appendix B. The effect of riverside borrow pits or natural low areas such as oxbows, must be considered in determining x_1 . The effective length of blanket x_1 should be the lesser of the distance based on the blanket thickness outside the riverside borrow pit and the distance based on the blanket thickness inside the riverside borrow pit plus the distance from the riverside toe of the levee to the borrow pit. The blanket equations assume an infinite blanket length. However, this assumption may not be valid if the river is close to the levee. If the computed value of x_1 is greater than L_1 (distance from riverside toe of levee to the river), then x_1 should equal L_1 . Distances to effective sources of seepage, effective lengths of riverside blankets, and vertical permeabilities of riverside blanket materials at different sites along the Mississippi River at the crest of the 1950 high water period are given in Table C-1. The values of x_1 are observed values adjusted to an assumed condition of a riverside blanket of infinite length with the same thickness as that of the borrow pit. The adjustment was made by use of blanket equations presented in Appendix B to partially eliminate the effect of different top strata riverward of the borrow pits and different distances between the levee and river at various sites.

c. The thickness d and permeability k_r of the pervious materials between the bottom of the blanket and the entrenched valley must be determined before designing a seepage berm. In Appendix B, paragraph B-4c, methods are described for determining d and k_r .

d. The permeability k_{bl} and effective thickness z_{bl} of the landside blanket must be determined before the seepage exit length x_3 can be computed. If the blanket is composed of more than one stratum and the vertical permeability of each stratum is known, the thickness of each stratum of the blanket can be transformed into an equivalent thickness of material having the same permeability as for one of the strata. A procedure and example for transforming the actual thickness of a stratified blanket into an effective thickness z_{bl} with a uniform vertical permeability is described in Appendix B, paragraph B-4b(2). The critical thickness of the landside top stratum z_t that should be used to determine if uplift pressure is within safe limits may or may not be equal to z_{bl} for stratified layers. The procedure and examples for computing z_t for different conditions of soil stratification are also presented in Appendix B, paragraph B-4b(2).

Table C-1a
Summary of Distances to Effective Source of Seepage, Effective Lengths of Riverside Blankets, and Vertical Permeability of Riverside Blanket Materials at the Crest of 1950 High Water (Metric Units)

Soil Type	Blanket in Riverside Borrow Pit Thickness in m	Number of Piezometer Lines from Which Data Were Obtained	S, m			x_i, m^a			$k_v \times 10^{-4} \text{ cm/sec}$			Suggested Design Values	
			Max	Avg	Min	Max	Min	Avg	Max	Min	Avg	k_v	x_i, m
Sand --	3	304.8	243.8	292.6	146.3	61	112.8	--	--	--	--	76.2	
Silty sand ^d	<1.52	3	243.8	170.7	204.2	97.5	70.1	85.3	14.2	1.6	7.0	7.0	91.4
	1.52 to 3.05	1	170.7	170.7	170.7	85.3	85.3	85.3	1.8	1.8	1.8	5.7 ^e	182.9
Silt and sandy silt	<1.52	4	457.2	182.9	320	371.8	83.3	204.2	7.4	0.24	2.2	2.2	121.9
	1.52 to 3.05	2	487.7	277.4	384	362.7	155.4	259.1	5.0	0.33	2.7	1.5	243.8
Clay	>3.05										2.4 ^e	1.0	365.8
	<1.52	6	390.1	185.9	310.9	228.6	33.6	210.3	1.7	0.34	0.79	0.8	182.9
	1.52 to 3.04	2	524.3	463.3	493.8	387.1	326.1	356.6	1.3 ^d	0.86 ^d	1.08 ^d	0.5	396.2
	3.05 to 4.58	2	--	--	--	--	--	--	--	--	--	0.2	762.0
	>4.58	3	960.1	243.8	487.7	∞	∞	∞	0.0	0.00	0.00	0.05	1219.2 ^f or L_1

^a Values of x_i computed from observed values of x and adjusted to a condition where $L = \infty$.
^b Does not include Hole-in-the-Wall where values of S and x may not be reliable because artesian flow conditions did not develop until near the crest of the 1950 high water.
^c Averages of all values of k_v for a given soil type without regard to thickness.
^d Values are considered to be too high as at these piezometer lines (Upper Francis) seepage could enter the pervious substratum through a silty blanket riverward of the borrow pit as well as through the clay in the borrow pit.
^e Use the smaller of the two values.
^f Average does not include k_v for blanket thickness between 1.52 and 3.05 m.

Table C-1b
Summary of Distances to Effective Source of Seepage, Effective Lengths of Riverside Blankets, and Vertical Permeability of Riverside Blanket Materials at the Crest of 1950 High Water (English Units)

Soil Type	Blanket in Riverside Borrow Pit	Thickness in ft	Number of Piezometer Lines from Which Data Were Obtained	S, ft		x _i , ft ^a		k _v , x 10 ⁻⁴ cm/sec		Suggested Design Values		
				Max	Min	Max	Min	Max	Min	Avg	Avg	k _v
Sand --		3	1080	800	960	480	200	370	--	--	--	250
Silty sand ^d		<5	3	800	560	670	320	230	280	14.2	1.6	7.0
		5 to 10	1	560	560	560	280	280	280	1.8	1.8	1.8 5.7 ^c
Silt and sandy silt		<5	4	1500	600	1050	1220	270	670	7.4	0.24	2.2
		5 to 10	2	1600	910	1260	1190	510	850	5.0	0.33	2.7 1.5
Clay		>10									2.4 ^e	1.0
		<5	6	1280	610	1020	750	110	690	1.7	0.34	0.79
		5 to 10	2	1720	1520	1620	1270	1070	1170	1.3 ^d	0.86	1.08
		10 to 15	0	--	--	--	--	--	--	--	--	--
		>15	3	3150	800	1600	∞	∞	∞	0.0	0.00	0.00 0.4 ^{c,f}

^a Values of x_i computed from observed values of x and adjusted to a condition where L = ∞.
^b Does not include Hole-in-the-Wall where values of S and x may not be reliable because artesian flow conditions did not develop until near the crest of the 1950 high water.
^c Averages of all values of k_v for a given soil type without regard to thickness.
^d Values are considered to be too high as at these piezometer lines (Upper Francis) seepage could enter the pervious substratum through a silty blanket riverward of the borrow pit as well as through the clay in the borrow pit.
^e Use the smaller of the two values.
^f Average does not include k_v for blanket thickness between 5 and 10 ft.

e. The seepage exit length x_3 can be calculated from equations presented in Appendix B, paragraph B-4g. These equations are applicable to conditions where the length of the landside blanket L_3 is either infinite or finite.

C-3. Design Equations and Criteria

a. *Design equations.* Equations for the design of landside seepage berms for the four major berm types are presented in Figure C-1. These equations are valid when a landside blanket of infinite length exists. A discussion of the four major landside seepage berms is presented in paragraph 5-4.

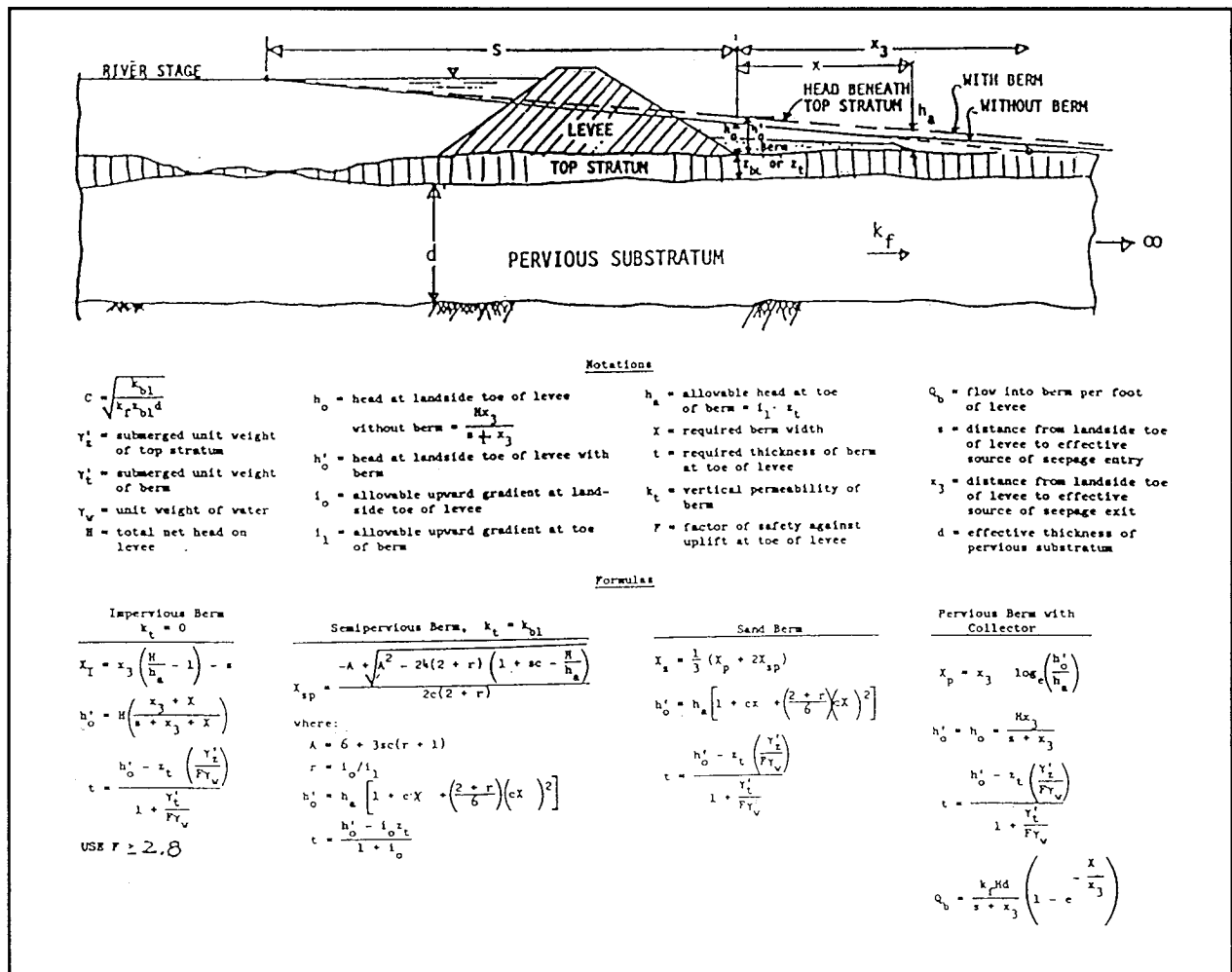

Figure C-1. Design of landside seepage berms on impervious top stratum

b. Design criteria

(1) Where a levee overlies a top stratum creating a landside blanket and the upward gradient through the blanket at the landside toe of the levee is greater than 0.8, a seepage berm should be designed with an allowable upward gradient of 0.3 through the blanket and berm at the landside toe of the levee. For a

saturated unit soil weight of 1840 kg/m³ (115 pcf), this is equivalent to a factor of safety of 2.8. The factor of safety of 2.8 applies only to new construction, not to existing projects. A factor of safety lower than 2.8 may be used, based on sufficient soil data and past performance in the area. The berm width should be based on an allowable upward gradient of 0.8 through the top stratum at the landside toe of the berm, subject to the limitations in the paragraphs which follow. The thickness of the berm should be increased 25 percent to allow for shrinkage, foundation settlements and variations in design factors. Where field observations during lesser floods indicate severe seepage problems would occur at the design flood, the berm dimensions should be extended.

(2) All berms should have minimum thickness of 1.52 m (5 ft) at the levee toe, a minimum thickness of 0.61 m (2 ft) at the berm crown, and a minimum width of 45.7 m (150 ft).

(3) For conditions where the computed upward gradient at the landside toe of the levee is between 0.5 and 0.8 without a berm, a berm with minimum dimensions as specified in (2) above should be constructed. Also for conditions where the computed gradient is less than 0.5, but either severe seepage has been observed or seepage is expected to become severe and soften the landside portion of the levee, the minimum berm should be constructed.

(4) The width of the berm is usually limited to about 91.4 to 121.9 m (300 to 400 ft), although the design calculations may indicate that a greater berm width is required. When the selected width of the berm is less than the calculated width, using berm design equations of Figure C-1, the head h_o' and berm thickness t at the levee toe will be less than for the computed width. For the selected berm, h_o' should be recomputed assuming an i_1 of 0.8 at the toe of the new berm and a linear piezometric grade line between the toe of the new berm and the point of effective seepage entry. The design thickness of the selected berm at the toe of the levee and the estimated seepage flow under the levee will be based on the value of h_o' corresponding to the selected berm.

(5) For conditions where no landside blanket exists, the necessity for a landside seepage berm will be based on the exit gradient and seepage velocity as discussed in paragraph B-5b. The berm thickness at the landside toe should be of such magnitude that the upward gradient i_o does not exceed 0.3. The design thickness of the berm should be increased by 25 percent to allow for shrinkage, foundation settlements, and variations in design factors. The head h_o' beneath the berm at the landside toe of the levee can be determined from Equation C-1.

$$h_o' = \frac{H(X + 0.43 \bar{D})}{x_1 + L_2 + X + 0.43 \bar{D}} \quad (C-1)$$

In the above equation \bar{D} is the transformed thickness of the pervious stratum which is equal to $d\sqrt{k_h/k_v}$, L_2 is the base width of the levee, H is the total net head on levee, X is the berm width, and x_1 is the effective length of impervious blanket riverside of the levee. If no riverside blanket exists, the value of x_1 is assumed to be $0.43 \bar{D}$. The rate of seepage Q_s below the levee per unit length of levee can be determined using Equation C-2.

$$Q_s = \frac{k_f H d}{x_1 + L_2 + X + 0.43 \bar{D}} \quad (C-2)$$

In the equation above, k_f is the permeability of the pervious substratum and d is the effective thickness of the pervious substratum. H , x_1 , L_2 , X , and \bar{D} are as previously defined. If Q_s exceeds 757.1 ℓ/min (200 gal/min) per 30.5 m (100 ft) of levee, a riverside blanket should be designed to reduce the seepage. Riverside blankets are discussed in paragraph 5-3.

(6) The slope of berms should be generally 1V on 50H or steeper to ensure drainage. If the berm is constructed after the levee has caused the foundation to consolidate fully, a slope of 1V on 75H can be used. Where wide, thick berms are required, consideration may be given to using a berm with a broken surface slope to more closely simulate the theoretical thickness and consequently reduce the cost of the berm. Where this is done, the steeper riverward slope of the berm should be no flatter than 1V on 75H and the landward slope of the berm should be no flatter than 1V on 100H.

(7) In short reaches where computations indicate no berm is necessary, but berms are required in adjacent reaches, it may be advisable to continue the berm construction through such reaches due to concentration of seepage in these areas. Also, in areas where entrance conditions in adjacent reaches are highly variable, potential adverse effects of close entry in adjacent reaches should be taken in to consideration.

C-4. Design Example

An example design problem with solution is presented in Table C-2 illustrating the design of impervious, semipervious, sand, and free draining landside seepage berms overlaying a thin landside top stratum. Each berm is designed for the same conditions using the design equations and design criteria as presented in this appendix.

Table C-2a
Examples of Design of Seepage Berms (Metric Units)

Designs based on following conditions:

H = 7.6 m	$z_{bl} = z_1 = 1.83$ m	$\gamma' = 840.5$ kg/m ³ for impervious berms
$k_f = 1,000 \times 10^{-4}$ cm/sec	$i_b = 0.30$	$\gamma' = 920.6$ kg/m ³ for sand berm or pervious berm with collector, F = 1.6
d = 30.5 m	$i_1 = 0.80$	F = 1.6 for impervious berm
$k_{bl} = 3 \times 10^{-4}$ cm/sec	$\gamma' = 840.5$ kg/m ³	$L_3 = \infty$
s = 304.8 m	$x_3 = 137.2$ m	

Type Berm	Required Berm		Suggested Design Dimensions			Suggested Construction Dimensions			Approximate ^d Material Required m ³ per 100 m of Levee	
	Width X, m	Thickness t, m	Thickness at Berm Crown m	Berm Width X, m	Berm Slope	Approximate Levee Thickness Toe m	Thickness at Berm Crown m	Berm Width X, m		Toe m
Impervious	268.2	2.22	0.61	243.8 ^e	1 on 75	3.87	0.76	243.8	4.85	73,266
		1.49	0.61	121.9	1 on 75	2.22	0.76	121.9	2.77	23,312
Semipervious	85.34	1.16	0.61	83.82	1 on 75	1.74	0.76	83.82	2.16	13,321
Sand	79.20	1.0	0.61	76.20	1 on 75	1.61	0.76	76.20	2.01	11,528
Pervious with collector	65.53	0.88	0.61	60.96	1 on 75	1.43	0.76	60.96	1.80	8,454 ^f

^a At toe of levee.

^b Head at toe of levee with berm, measured above surface of natural ground.

^c Thickness increased 25 percent for shrinkage, foundation settlements, and variations in design factors.

^d Calculations based on suggested construction dimensions.

^e Berm width considered longer than necessary. If berms developed 121.9 m or farther landward of the toe of the levee, the levee probably would not be endangered.

Therefore, an alternate design for an impervious berm with a width of 121.9 m is also given.

^f Sand and gravel blankets and collector system are also required.

Table C-2b
Examples of Design of Seepage Berms (English Units)

Designs based on following conditions:

H = 25 ft	$z_{bl} = z = 6.0$ ft	$\bar{a}' = 52.5$ pcf for impervious berms
$k_f = 1,000 \times 10^{-4}$ cm/sec	$i_o = 0.30$	$\bar{a}' = 57.5$ pcf for sand berm or pervious berm with collector, $F = 1.6$
d = 100 ft	$i_1 = 0.80$	$F = 1.6$ for impervious berm
$k_{bl} = 3 \times 10^{-4}$ cm/sec	$\bar{a}' = 52.5$ pcf	$L_3 = \infty$
s = 1,000 ft	$x_3 = 450$ ft	

Type Berm	Required Berm		Suggested Design Dimensions				Suggested Construction Dimensions			Approximate Material Required yd per 100 ft of Levee
	Width X_1 , ft	Thickness ^a t , ft	Thickness at Berm Crown ft	Berm Width X_1 , ft	Berm ^b Slope	Approximate Thickness Levee Toe ft	Thickness at Berm Crown ft	Berm Width X_1 , ft	Thickness at Levee Toe ft	
Impervious	880	7.3 4.9	14.2 10.6	800 ^e 400	1 on 75 1 on 75	12.7 7.3	2.5 2.5	800 400	15.9 9.1	28,600 9,100
Semipervious Sand	280 260	3.8 3.3	8.6 8.3	275 250	1 on 75 1 on 75	5.7 5.3	2.5 2.5	275 250	7.1 6.6	5,200 4,500
Pervious with collector	215	2.9	7.7	200	1 on 75	4.7	2.5	200	5.9	3,300 ^f

^a At toe of levee.

^b Head at toe of levee with berm, measured above surface of natural ground.

^c Thickness increased 25 percent for shrinkage, foundation settlements, and variations in design factors.

^d Calculations based on suggested construction dimensions.

^e Berm width considered longer than necessary. If boils developed 400 ft or farther landward of the toe of the levee, the levee probably would not be endangered. Therefore, an alternate design for an impervious berm with a width of 400 ft is also given.

^f Sand and gravel blankets and collector system are also required.

Appendix D Filter Design

D-1. General

The objective of filters and drains used as seepage control measures for embankments is to efficiently control the movement of water within and about the embankment. In order to meet this objective, filters and drains must, for the project life and with minimum maintenance, retain the protected materials, allow relatively free movement of water, and have sufficient discharge capacity. For design, these three necessities are termed, respectively, piping or stability requirement, permeability requirement, and discharge capacity. This appendix will explain how these requirements are met for cohesionless and cohesive materials, and provide general construction guidance for installation of filters and drains. The terms filters and drains are sometimes used interchangeably. Some definitions classify filters and drains by function. In this case, filters must retain the protected soils and have a permeability greater than the protected soil but do not need to have a particular flow or drainage capacity since flow will be perpendicular to the interface between the protected soil and filter. Drains, however, while meeting the requirements of filters, must have an adequate discharge capacity since drains collect seepage and conduct it to a discharge point or area. In practice, the critical element is not definition, but recognition, by the designer, when a drain must collect and conduct water. In this case the drain must be properly designed for the expected flows. Where it is not possible to meet the criteria of this appendix, the design must be cautiously done and based on carefully controlled laboratory filter tests.

D-2. Stability

Filters and drains¹ allow seepage to move out of a protected soil more quickly than the seepage moves within the protected soil. Thus, the filter material must be more open and have a larger grain size than the protected soil. Seepage from the finer soil to the filter can cause movement of the finer soil particles from the protected soil into and through the filter. This movement will endanger the embankment.² Destruction of the protected soil structure may occur due to the loss of material. Also, clogging of the filter may occur causing loss of the filter's ability to remove water from the protected soil. Criteria developed by many years of experience are used to design filters and drains which will prevent the movement of protected soil into the filter. This criterion, called piping or stability criterion, is based on the grain-size relationship between the protected soil and the filter. In the following, the small character "d" is used to represent the grain size for the protected (or base) material and the large character "D" the grain size for the filter material.

Determine filter gradation limits using the following steps:³

1. Determine the gradation curve (grain-size distribution) of the base soil material. Use enough samples to define the range of grain sizes for the base soil or soils and design the filter gradation based on the base soil that requires the smallest D_{15} size.

¹ In paragraphs D-2 and D-3 the criteria apply to drains and filters; for brevity, only the word filter will be used.

² In practice, it is normal for a small amount of protected soil to move into the filter upon initiation of seepage. This action should quickly stop and may not be observed when seepage first occurs. This is one reason that initial operation of embankment seepage control measures should be closely observed by qualified personnel.

³

Guide for Determining the Gradation of Sand and Gravel Filters, Soil Mechanics Note No. 1, U.S. Department of Agriculture Soil Conservation Services, Engineering Division, January 1986.

2. Proceed to step 4 if the base soils contains no gravel (materials larger than No. 4 sieve).
3. Prepare adjusted gradation curves for base soils with particles larger than the No. 4 (4.75 mm) sieve.
 - a. Obtain a correction factor dividing 100 by the percent passing the No. 4 (4.75 mm) sieve.
 - b. Multiply the percentage passing each sieve size of the base soil smaller than No. 4 (4.75 mm) by the correction factor from step 3a.
 - c. Plot these adjusted percentages to obtain a new gradation curve.
 - d. Use the adjusted curve to determine the percent passing the No. 200 (0.075 mm) sieve in step 4.
4. Place the base soil in a category based on the percent passing the No. 200 (0.075 mm) sieve in accordance with Table D-1.

Table D-1
Categories of Base Soil Materials

Category	Percent Finer Than the No. 200 (0.075 mm) Sieve
1	>85
2	40-85
3	15-39
4	<15

5. Determine the maximum D_{15} size for the filter in accordance with Table D-2. Note that the maximum D_{15} is not required to be smaller than 0.20 mm.
6. To ensure efficient permeability, set the minimum D_{15} greater than or equal to 3 to $5 \times$ maximum d_{15} of the base soil before regrading but no less than 0.1 mm.
7. Set the maximum particle size at 75 mm (3 in.) and the maximum passing the No. 200 (0.075 mm) sieve at 5 percent. The portion of the filter material passing the No. 40 (0.425 mm) sieve must have a plasticity index (PI) of zero when tested in accordance with EM 1110-2-1906, "Laboratory Soils Testing."
8. Design the filter limits within the maximum and minimum values determined in steps 5, 6, and 7. Standard gradations may be used if desired. Plot the limit values, and connect all the minimum and maximum points with straight lines. To minimize segregation and related effects, filters should have relatively uniform grain-size distribution curves, without "gap-grading"—sharp breaks in curvature indicating absence of certain particle sizes. This may require setting limits that reduce the broadness of filters within the maximum and minimum values determined. Sand filters with D_{90} less than about 20 mm generally do not need limitations on filter broadness to prevent segregation. For coarser filters and gravel zones that serve both as filters and drains, the ratio D_{90}/D_{10} should decrease rapidly with increasing D_{10} size. The limits in Table D-3 are suggested for preventing segregation during construction of these coarser filters.

Table D-2
Criteria for Filters

Base Soil Category	Base Soil Description and Percent Finer Than the No. 200 (0.075 mm) Sieve (a)	
1	Fine silts and clays; more than 85 percent finer	(c) $D_{15} \leq 9 \times d_{85}$
2	Sands, silts, clays and silty and clayey sands; 40 to 85 percent finer	$D_{15} \leq 0.7 \text{ mm}$
3	Silty and clayey sands and gravels; 15 to 39 percent finer	(d), (e) $D_{15} \leq \left(\frac{40 - A}{40 - 15} \right) [(4 \times d_{85}) - 0.7 \text{ mm}] + 0.7$
4	Sands and gravels; less than 15 percent finer	(f) $D_{15} \leq 4 \text{ to } 5 \times d_{85}$

- (a) Category designation for soil containing particles larger than 4.75 mm is determined from a gradation curve of the base soil which has been adjusted to 100 percent passing the No. 4 (4.75 mm) sieve.
- (b) Filters are to have a maximum particle size of 75 mm (3 in.) and a maximum of 5 percent passing the No. 200 (0.075 mm) sieve with the plasticity index (PI) of the fines equal to zero. PI is determined on the material passing the No. 40 (0.425 mm) sieve in accordance with EM 1110-2-1906, "Laboratory Soils Testing." To ensure sufficient permeability, filters are to have a D_{15} size equal to or greater than $4 \times d_{15}$ but no smaller than 0.1 mm.
- (c) When $9 \times d_{85}$ is less than 0.2 mm, use 0.2 mm.
- (d) A = percent passing the No. 200 (0.075 mm) sieve after any regrading.
- (e) When $4 \times d_{85}$ is less than 0.7 mm, use 0.7 mm.
- (f) In category 4, the $D_{15} \leq 4 \times d_{85}$ criterion should be used in the case of filters beneath riprap subject to wave action and drains which may be subject to violent surging and/or vibration.

Table D-3
 D_{10} and D_{90} Limits for Preventing Segregation

Minimum D_{10} (mm)	Maximum D_{90} (mm)
< 0.5	20
0.5 - 1.0	25
1.0 - 2.0	30
2.0 - 5.0	40
5.0 - 10	50
10 - 50	60

D-3. Permeability

The requirement that seepage move more quickly through the filter than through the protected soil (called the permeability criterion) is again met by a grain-size relationship criterion based on experience:

Permeability

$$\frac{15 \text{ percent size of filter material}}{15 \text{ percent of the protected soil}} \geq 3 \text{ to } 5 \quad (\text{D-1})$$

Permeability of a granular soil is roughly proportional to the square of the 10- to 15-percent size material. Thus, the permeability criterion ensures that filter materials have approximately 9 to 25 or more times the permeability of the protected soil. Generally, a permeability ratio of at least 5 is preferred; however, in the case of a wide band of uniform base material gradations, a permeability ratio as low as 3 may be used with respect to the maximum 15-percent size of the base material. There may be situations, particularly where the filter is not part of a drain, where the permeability of the filter is not important. In those situations, this criterion may be ignored.

D-4. Applicability

The previously given filter criteria in Table D-2 and Equation D-1 are applicable for all soils (cohesionless or cohesive soils) including dispersive soils.¹ However, laboratory filter tests for dispersive soils, very fine silt, and very fine cohesive soils with high plastic limits are recommended.

D-5. Perforated Pipe²

The following criteria are applicable for preventing infiltration of filter material into perforated pipe, screens, etc.:

$$\frac{\text{Minimum 50 percent size of filter material}}{\text{hole diameter or slot width}} \geq 1.0 \quad (\text{D-2})$$

In many instances a filter material meeting the criteria given by Table D-2 and Equation D-1 relative to the material being drained is too fine to meet the criteria given by Equation D-2. In these instances, multilayered or "graded" filters are required. In a graded filter each layer meets the requirements given by Table D-2 and Equation D-1 with respect to the pervious layer with the final layer in which a collector pipe is bedded also meeting the requirements given by Equation D-2. Graded filter systems may also be needed when transitioning from fine to coarse materials in a zoned embankment or where coarse material is required for improving the water-carrying capacity of the system.

D-6. Gap-Graded Base

The preceding criteria cannot, in most instances, be applied directly to protect severely gap- or skip-graded soils. In a gap-graded soil such as that shown in Figure D-1. The coarse material simply floats in the matrix of fines. Consequently, the scattered coarse particles will not deter the migration of fines as they do in a well-graded material. For such gap-graded soils, the filter should be designed to protect the fine matrix rather than the total range of particle sizes. This is illustrated in Figure D-1. The 85-percent size of the total sample is 5.2 mm. Considering only the matrix material, the 85-percent size would be 0.1 mm resulting in a much finer filter material being required. This procedure may also be followed in some instances where the material being drained has a very wide range of particle sizes (e.g., materials graded from coarse gravels to significant percentages of silt or clay). For major structures such a design should be checked with filter tests.

¹

Sherard, J. L., Dunnigan, L. P., "Filters and Leakage Control in Embankment Dams," *Proceeding of the Symposium on Seepage and Leakage from Dams and Impoundments*, ASCE National Convention, Denver, Colorado, 1985.

²

EM 1110-2-2300 states, "Collector pipe should not be placed within the embankment, except at the downstream toe, because of the danger of either breakage or separation of joints, resulting from fill placement and compaction operations, or settlement, which might result in either clogging and/or piping."

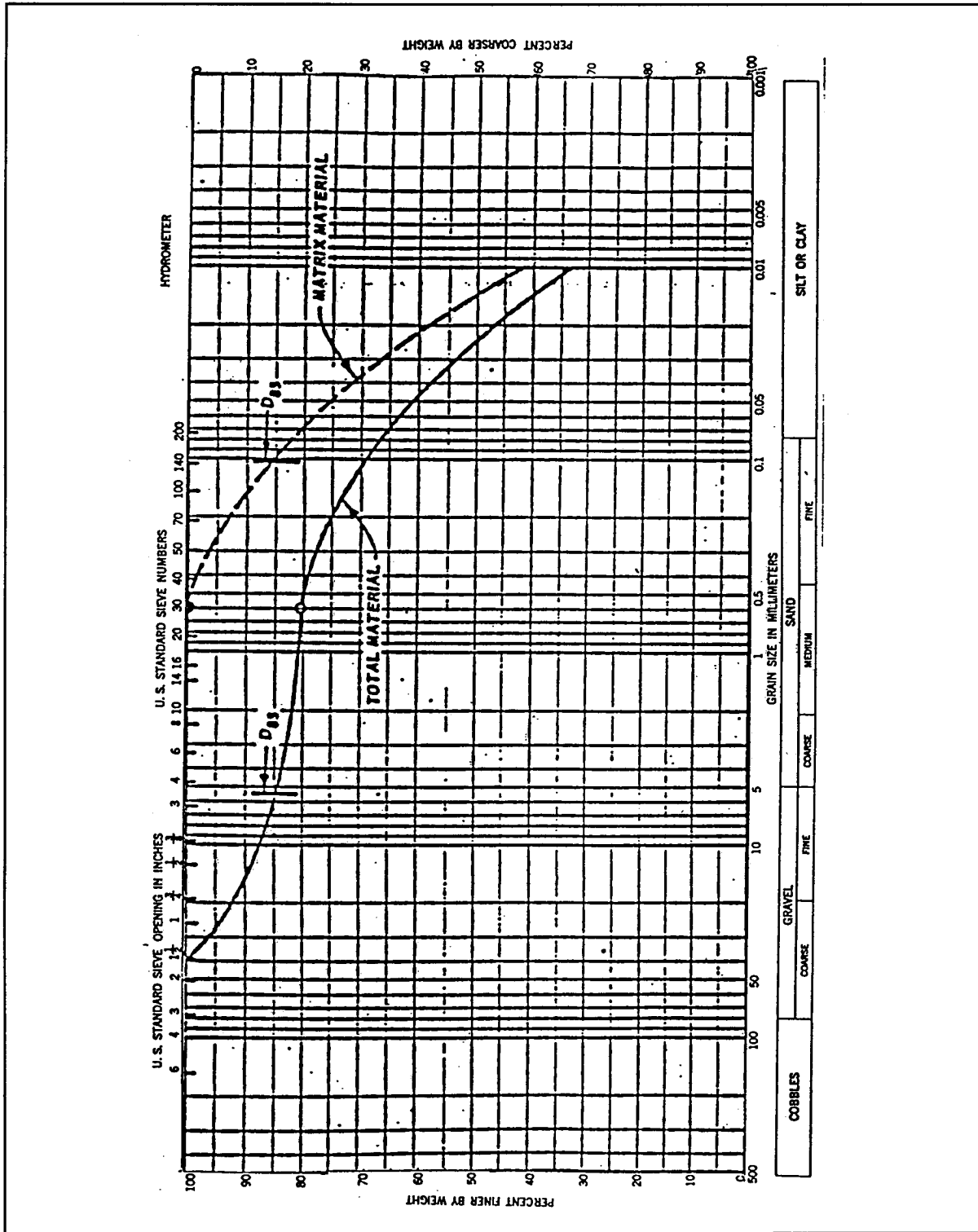

Figure D-1. Analysis of a gap-graded material

D-7. Gap-Graded Filter

A gap-graded filter material must never be specified or allowed since it will consist of either the coarse particles floating in the finer material or the fine material having no stability within the voids produced by the coarse material. In the former case the material may not be permeable enough to provide adequate drainage. The latter case is particularly dangerous since piping of the protected material can easily occur through the relatively large, loosely filled voids provided by the coarse material.

D-8. Broadly Graded Base

One of the more common soils used for embankment dams is a broadly graded material with particle sizes ranging from clay sizes to coarse gravels and including all intermediate sizes. These soils may be of glacial, alluvial-colluvial, or weathered rock origin. As noted by Sherard (1979)¹, since the 85-percent size of the soil is commonly on the order of 20 to 30 mm, a direct application of the stability criteria $D_{15}/d_{85} \leq 4$ to 5 would allow very coarse uniform gravel without sand sizes as a downstream filter, which would not be satisfactory. The typical broadly graded soils fall in Soil Category 2 in Table D-2 and require a sand or gravelly filter with $D_{15} \leq 0.7$ mm.

D-9. Example of Graded Filter Design for Drain

Seldom, if ever, is a single gradation curve representative of a given material. A material is generally represented by a gradation band which encompasses all the individual gradation curves. Likewise, the required gradation for the filter material is also given as a band. The design of a graded filter which shows the application of the filter criteria where the gradations are represented by bands is illustrated in Figure D-2. A typical two-layer filter for protecting an impervious core of a dam is illustrated. The impervious core is a fat clay (CH) with a trace of sand which falls in Category 1 soil in Table D-2. The criterion $D_{15} \leq 9 \times d_{85}$ is applied and a "point a" is established in Figure D-2. Filter material graded within a band such as that shown for Filter A in Figure D-2 is acceptable based on the stability criteria. The fine limit of the band was arbitrarily drawn, and in this example, is intended to represent the gradation of a readily available material. A check is then made to ensure that the 15-percent size of the fine limit of the filter material band (point b) is equal to or greater than 3 to 5 times the 15-percent size of the coarse limit of the drained material band (point c). Filter A has a minimum D_{10} size and a maximum D_{90} size such that, based on Table D-3, segregation during placement can be prevented. Filter A meets both the stability and permeability requirements and is a suitable filter material for protecting the impervious core material. The second filter, Filter B, usually is needed to transition from a fine filter (Filter A) to coarse materials in a zoned embankment dam. Filter B must meet the criteria given by Table D-2 with respect to Filter A. For stability, the 15-percent size of the coarse limit of the gradation band for the second filter (point d) cannot be greater than 4 to 5 times the 85-percent size of the fine limit of the gradation bank for Filter A (point e). For permeability, the 15-percent size of the fine limit (point f) must be at least 3 to 5 times greater than the 15-percent size of the coarse limit for Filter A (point a). With points d and f established, the fine and coarse limits for Filter B may be established by drawing curves through the points approximately parallel to the respective limits for Filter A. A check is then made to see that the ratio of maximum D_{90} /minimum D_{10} size Filter B is approximately in the range as indicated in Table D-3. A well-graded filter which usually would not meet the requirements in Table D-3 may be used if segregation can be controlled during placement. Figure D-2 is intended to show only the principles of filter design. The design of thickness of a filter for sufficient seepage discharge capacity is done by applying Darcy's Law, $Q = k i a$.

¹ Sherard, J. L., "Sinkholes in Dams of Coarse, Broadly-Graded Soils," Transactions of the 13th International Congress on Large Dams, New Delhi, India, Vol. II, 1979, pp 25-35.

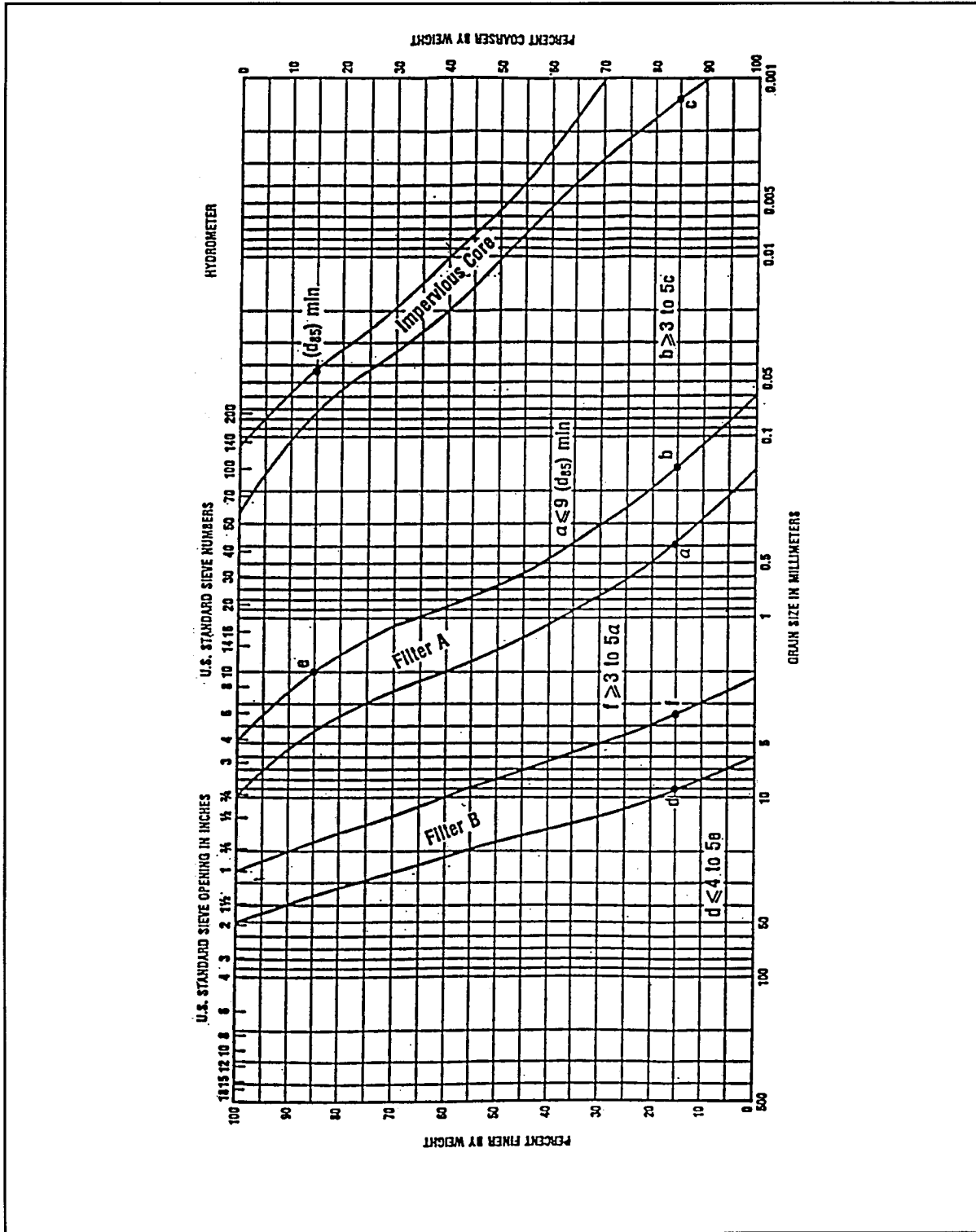

Figure D-2. Illustration of the design of a graded filter

D-10. Construction

EM 1110-2-1911 and EM 1110-2-2300 provide guidance for construction. Major concerns during construction include:

a. Prevention of contamination of drains and filters by runoff containing sediment, dust, construction traffic, and mixing with nearby fine-grained materials during placement and compaction. Drain and filter material may be kept at an elevation higher than the surrounding fine-grained materials during construction to prevent contamination by sediment-carrying runoff.

b. Prevention of segregation, particularly well-graded filters, during handling and placement.

c. Proper in-place density is usually required to be no less than 80-percent relative density. Granular materials containing little or no fines should be saturated during compaction to prevent “bulking” (low density) which can result in settlement when overburden materials are placed and the drain is subsequently saturated by seepage flows.

d. Gradation should be monitored closely so that designed filter criteria are met.

e. Thickness of layers should be monitored to ensure designed discharge capacity and continuity of the filter.

Thus, quality control/assurance is very important during filter construction because of the critical function of this relatively small part of the embankment.

D-11. Monitoring

Monitoring of seepage quantity and quality (see Chapter 13 of EM 1110-2-1901 for method of monitoring seepage) once the filter is functioning is very important to the safety of the embankment. An increase in seepage flow may be due to a higher reservoir level or may be caused by cracking or piping. The source of the additional seepage should be determined and action taken as required (see Chapters 12, 13, and 14 of EM 1110-2-1901). Decreases in seepage flows may also signal dangers such as clogging of the drain(s) with piped material, iron oxide, calcareous material, and effects of remedial grouting. Again, the cause should be determined and appropriate remedial measures taken. Drain outlets should be kept free of sediment and vegetation. In cold climates, design or maintenance measures should be taken to prevent clogging of drain outlets by ice.

Appendix E Drainage Trench

E-1. General

This appendix presents the design and analysis of drainage trenches. The design criteria and the example presented are taken from U.S. Army Engineer Waterways Experiment Station TM 3-424 (Appendix A).

E-2. Applicability

A drainage trench can be used to control underseepage where the top stratum is thin and the pervious foundation is relatively shallow so that the trench substantially penetrates the aquifer. Where the pervious foundation is deep, a drainage trench of moderate depth would attract only a small portion of the underseepage. The drainage trench method is known to be effective where the ratio of the thickness of the landside blanket, z_{bl} , to the depth of the pervious foundation, d , is greater than 25 percent. While only substantial penetration by the drainage trench provides significant landside relief, a trench with limited penetration may be used in conjunction with a landside blanket to contain seepage pressures.

E-3. Design Criteria

The design criteria and graphs are applicable only for homogeneous, isotropic pervious foundations having an impervious top stratum landward of the drainage trench. The distance from the source of seepage to the landside toe of the levee, S , to be used in the design may be estimated by a procedure outlined in Appendix B. Seepage into a drainage trench, Q_{st} , and the maximum head landside of the levee, h_{∞} , where the blanket landside of the levee consists of impervious or relatively impervious soil, can be computed using the graphs presented in Figure E-1. The analysis and design procedure is as follows:

a. Where $k_h > k_v$ transform the in situ pervious stratum into a homogeneous, isotropic formation using k'_f and d' for k_f and d , respectively, as follows:

$$k'_f = \sqrt{k_h k_v} \quad (E-1)$$

$$d' = d \sqrt{k_h/k_v} \quad (E-2)$$

where

- d = thickness of the pervious foundation
- k_h = coefficient of horizontal permeability
- k_v = coefficient of vertical permeability
- k'_f = transformed coefficient of permeability of the foundation
- d' = transformed depth of the pervious foundation

b. From the geometry of the drainage trench, Figure E-1, find the ratio of r_d/d , (Case I) or b_d/d (Case II) where:

- r_b = radius of the circular sector of the trench for Case I
- b_d = width of the rectangular trench section for Case II

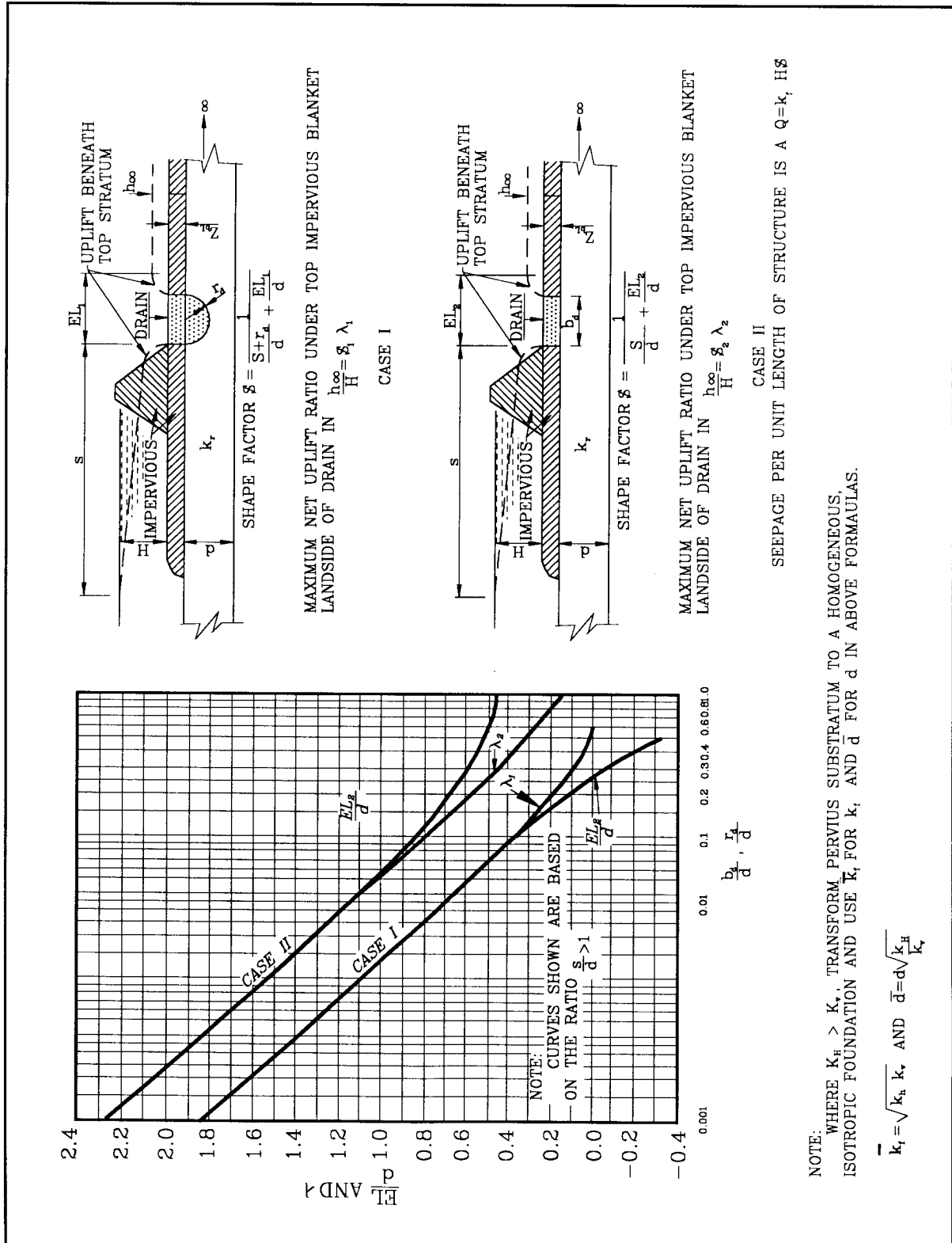

Figure E-1. Formulas and design curves for drainage trenches (ref. EM 1110-2-1601)

c. Use the computed ratio of r_d/d or b_d/d to enter the appropriate graph of Figure E-1 to determine the corresponding value of EL/d and \ddot{e} . The factor EL is the extra length of pervious substratums corresponding to the increased resistance to flow into a drainage trench as compared to a fully penetrated open trench, and \ddot{e} is an uplift factor. The values of EL_1/d and \ddot{e}_1 are related to Case I, while EL_2/d and \ddot{e}_2 are related to Case II.

d. Once the magnitude of EL is determined, the value of the shape factor S which is equivalent to the ratio in the flow net of the number of flow channels to the number of equipotential drops, can be determined as:

Case I:

$$S_1 = \frac{d}{S + r_d + EL_1} \quad (E-3)$$

Case II:

$$S_2 = \frac{d}{S + EL_2} \quad (E-4)$$

e. Calculate the quantity of discharge per unit length of the levee, Q_{st} , and the maximum head landside of the trench, h_∞ , using the following expressions:

$$Q_{st} = S k'_f H \quad (E-5)$$

$$h_\infty = H S \ddot{e} \quad (E-6)$$

where

H = total head acting on the levee, or the height of flood stage above the average low-ground surface or tail water

Where there is no top stratum landside of the levee, seepage flow into the drainage trench and beyond can be estimated from the flow net analysis.

E-4. Limitations of the Method

The method of controlling underseepage using the trench drain method has several limitations:

a. If the top stratum landside of the drainage trench has a certain degree of perviousness, seepage into the trench and the maximum head landward of the levee will be somewhat less than those computed from Figure E-1. Therefore, design based on Figure E-1 will be slightly on the conservative side if the top stratum landside of the drain trench is semipervious.

b. If the pervious foundation is highly stratified, seepage may bypass the drain and emerge landward of the drain thereby defeating its purpose. For such cases, other methods of seepage control are more effective.

c. If the trench is underlain by either impervious or semipervious strata of either clay, silt, or fine sand, the formulas presented in Part E-3 are no longer applicable.

E-5. Design Example

Figure E-2 illustrates the design of a drainage trench in a thin impervious blanket overlying a shallow pervious stratum. The trench drain (Case II) is designed using equations presented in Part E-3 of this appendix.

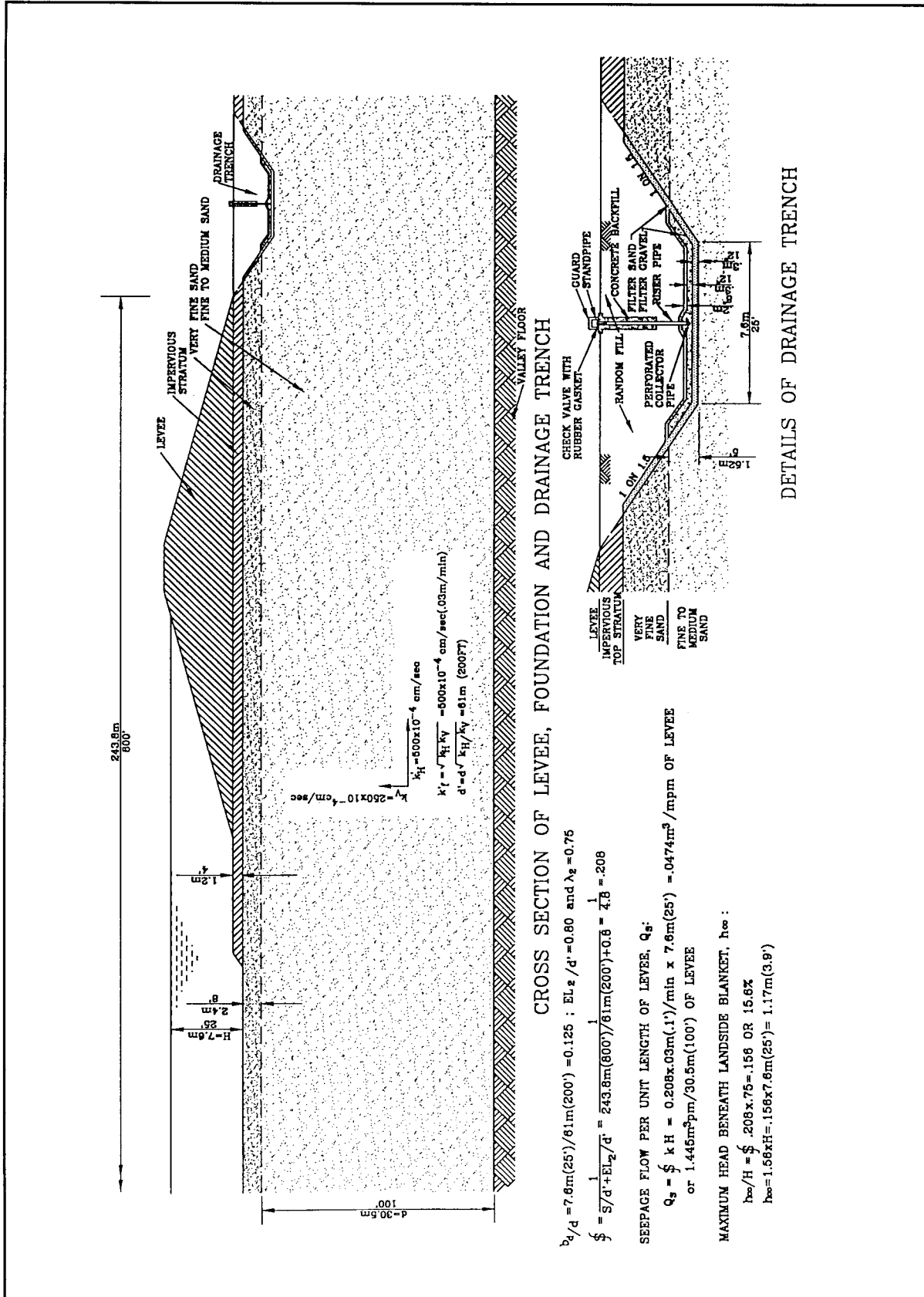

Figure E-2. Example of design of a drainage trench

Appendix F Emergency Flood Protection

F-1. Introduction

a. Flood fighting. Flood fighting can be defined as those emergency operations that are taken in advance of and during a flood to prevent or minimize damages to public and private property. As defined herein, flood fighting includes the hasty construction of emergency levees; the overbuilding of existing levees or natural river banks; ring and U-shaped levees constructed around facilities or areas of high property value; preservation of vital facilities including water treatment plants and wells; power and communication facilities; protection of sanitary and storm sewer systems; and provisions for interior drainage treatment during flood stages. Flood fighting plans should acknowledge that it may not be feasible to protect entire communities based on economic or time and equipment considerations; therefore, evacuation of certain areas may be a necessary facet of an emergency operation.

b. Recommended local organization. Each community with a flood history should establish an organization and written plans for the purpose of conducting flood fighting operations. These plans should include identification of flood-prone areas and previous high water marks; flood fighting or evacuation plans; delegation of responsibilities; lists of important suppliers of materials and special equipment; lists of local contractors; and establishment of earth borrow sites, etc. The plan should further provide for the establishment of an emergency operation center and list various assistance programs available, either through the State or Federal government. Further assistance in developing these plans can be provided by the State or local Civil Defense Director in the area.

F-2. Flood Barrier Construction

a. Introduction. The two basic features of an emergency levee system include the flood barrier, generally constructed of earth fill, and the related interior drainage treatment. It is desirable that individuals assigned to a flood-fight situation have prior knowledge of flood barrier construction, interior drainage, and related flood-fight problems which they may encounter. They should also be acquainted with the past flood emergency efforts, historical flood stages, and forecasted stages for the community. The following information will provide personnel with guidelines based on actual experience. However, it cannot be over emphasized that individual resourcefulness is a key element in a successful flood fight.

b. Preliminary work.

(1) Alignment. A complete alignment for the barrier should be established promptly and, if possible, in cooperation with State or local floodplain management officials. The alignment should be the shortest practical route, provide the maximum practical protection, and take advantage of any high ground where practicable. The flood barrier should be kept as far landward of the river as possible to prevent encroachment on the floodway and to provide maximum space for overbank flows. This is especially important for smaller floodways where encroachment would directly impact the water surface profile. Sharp bends should be avoided. Topographic, plat, or city street maps may be useful in selecting alignment. In choosing the alignment, consideration should be given as to whether sufficient time remains to complete construction before the flood crest arrival. Potentially unstable river banks should be avoided. Keep as many trees and brush between the levee and river as possible to help deflect current, ice, and debris. However, in constricted areas of the river, 1.52 m (5 ft), and preferably 3.05 m (10 ft), should be allowed between the levee toe and vertical obstructions such as trees. In urban areas, many communities within a flood prone

area already have some levees in-place. These communities typically fight the flood along this primary line of defense. Moving the alignment farther landward creates problems in determining methods to stop floodwater backup through storm and sanitary sewer lines. It could also leave storm and sanitary lift stations on the riverside of the flood barrier. Leaving some homes outside the line of protection also exposes the watermains to floodwater infiltration. Right-of-way considerations may also influence the final alignment. Generally, the city or county engineer will assist in laying out the line and grade for the barrier, or a professional surveyor may be available. However, if help is not available, a hand-level along with a known elevation can be used to lay out rough grade. As soon as the alignment is firm, quantities of earthwork should be estimated for establishing equipment and borrow requirements.

(2) Drainage. In laying out a flood barrier, the problem of interior drainage from snowmelt, rain, or sewer backup should be considered. A certain amount of ponding, if valuable property will not be damaged, is not detrimental and may be allowed. The excess interior water can be pumped out over the levee if pumps are available.

(3) Borrow area and haul road. The two prime requisites for a borrow area are that adequate material be available and that the site be accessible at all times. The quantity estimate plus an additional 50 percent should provide the basis for the area requirement. The area must be located so that it will not become isolated from the project by high water. The borrow area should also be located where the present water table, if known, and the water table levels caused by high water will not hinder or stop its use. If possible, a borrow area should be selected which will provide suitable materials for levee construction as covered below. Local contractors and local officials are the best source of information on available borrow areas. If undeveloped, the area should be cleared of brush, trees, and debris, with topsoil and surface humus being stripped. In cold regions in early spring, it will probably be necessary to rip the area to remove frozen material. An effort should be made to borrow from the area in such a manner that the area will be relatively smooth and free-draining when the operation is complete. The haul road may be an existing road or street, or it may have to be constructed. To mitigate damages it is highly desirable to use unpaved trails and roads, or to construct a road if the haul distance is short. In any case, the road should be maintained to avoid unnecessary traffic delays. The use of flagmen and warning signs is mandatory at major crossings such as highways, near schools, and at major pedestrian crossings. A borrow area, or source of sand for sandbags, should also be located promptly. This can become a critical item of supply in some areas due to long haul, project isolation, etc. It may become necessary to stockpile material near anticipated trouble areas.

(4) Equipment. One of the important considerations in earthwork construction is the selection of proper equipment to do the work. Under emergency conditions, obtaining normally specified earthwork equipment will be difficult and the work will generally be done with locally available equipment. It may be wise to call for technical assistance in the early contract stage to insure that proper and efficient equipment use is proposed. If possible, compaction equipment should be used in flood-barrier construction. This may involve sheepsfoot, rubber-tired, or vibratory rollers. Scrapers should be used for hauling when possible because of speed (on short haul) and large capacity. Truck haul, however, has been the most widely used. A ripper will be necessary for opening borrow areas in the early spring if the ground is frozen. A bulldozer of some size is mandatory on the job to help spread dumped fill and provide minimum compaction.

(5) Construction contract. The initiation of a construction contract under emergency conditions is very unique in that sole judgment as to the competence and capabilities of the contractor lies with field personnel. Field personnel, therefore, must be somewhat knowledgeable in construction operations. The initial contract is very important in that it delineates what equipment must be accounted for on the project and what is available for construction. During construction, if it becomes obvious that the equipment provided by the initial contract is inadequate to provide reasonably good construction or timely completion, a new or supplemental contract may be required. Procedures are the same as in the initial contract. Flexibility may be

built into the original contract if it can be foreseen that additional pieces of equipment will ultimately be used.

(6) Supplies. Early anticipation of floodfight problems will aid greatly in providing necessary and sufficient supplies on hand. These include sandbags, polyethylene, pumps, etc. The importance of initiative, resourcefulness, and foresight of the individual on the project cannot be over emphasized. Technical assistance may be invaluable in locating potential problem areas which, with proper materials at hand, could be alleviated early.

c. Earth fill levees.

(1) Foundation preparation. Prior to embankment construction, the foundation area along the levee alignment should be prepared. This is particularly important if the levee is to be left in place. Since spring flooding is the only condition providing much advance warning, the first item of work in cold regions probably will be snow removal. The snow should be pushed riverward so as to decrease ponding when the snow melts. Trees should be cut and the stumps removed. All obstructions above the ground surface should be removed, if possible. This will include brush, structures, snags, and similar debris. The foundation should then be stripped of topsoils and surface humus. (Clearing and grubbing, structure removal, and stripping should be performed only if time permits.) Stripping may be impossible if the ground is frozen. In this case, the foundation should be ripped or scarified, if possible, to provide a rough surface for bond with the embankment. Every effort should be made to remove all ice or soil containing many ice lenses. Frost or frozen ground can give a false sense of security in the early stages of a flood fight. It can act as a rigid boundary and support the levee; but on thawing, soil strength may be reduced sufficiently for cracks or slides to develop. It also forms an impervious barrier to prevent seepage. This may result in a considerable buildup in pressure under the soils landward of the levee, and upon thawing pressure may be sufficient to cause sudden blowouts. If this condition exists it must be monitored, and one must be prepared to act quickly if sliding or sand boils develop. If stripping is possible, the material should be pushed landward and riverward of the toe of levee and windrowed. After the flood, this material may be spread on the slopes to provide topsoil for vegetation.

(2) Materials. Earth fill materials for emergency levees will usually come from local borrow areas. An attempt should be made to utilize materials which are compatible with the foundation materials. Due to time limitations, however, any local materials may be used if reasonable construction procedures are followed. The material should be relatively clean (free of debris) and should not contain large frozen pieces of earth.

(a) Clay. Clay is preferred because the section can be made smaller (steeper side slopes). Clay is also relatively impervious (will not readily permit passing of water) and has relatively high resistance to erosion in a compacted state. A disadvantage in using clay is that adequate compaction is difficult to obtain without proper equipment and when the material is wet. Another disadvantage is if the clay is wet and sub-freezing temperatures occur, this may cause the material to freeze in the borrow pit and hauling equipment. Weather could cause delays and should definitely be considered in the overall construction effort.

(b) Sand. If sand is used, the section should comply as closely as possible with recommendations in paragraph F-2.C.(3)(b) below. Steep slopes without poly coverage on the riverside slope will result in seepage through the levee that exits on the landward slope causing slumping of the slope and potential overall failure if it occurs over an extended period of time.

(c) Silt. Material which is primarily silt should be avoided. If used, poly facing must be applied to the river slope. In addition to being very erodible, silt, upon wetting, tends to collapse if not properly compacted.

(3) Levee section.

(a) General. In standard levee design the configuration of the levee is generally dictated by the foundation soils and the materials available for construction. Therefore, even under emergency conditions, an attempt should be made to make the embankment compatible with the foundation. Information on foundation soils may be available from local officials or engineers, and it should be utilized. The two levee sections cited below are classical and idealized, and usual field conditions depart from them to various degrees. However, if they are used as a guide, possible serious flood-fight problems could be lessened during high water. In determining the top width of any type of section, consideration should be given as to whether a revised forecast will require additional fill to be placed. A top width adequate for construction equipment will facilitate raising the levee. Finally, actual dike construction will, in most cases, depend on time, materials, and right-of-way available.

(b) Sand section. Use 1 V (Vertical) on 3 H (Horizontal) toward a river, 1 V on 5 H landward slope, and 3.05-m (10-ft) top width.

(c) Clay section. Generally 1 V on 2 1/2 H slopes are used but for low height levees 1 V on 2 H slopes have been used successfully. It is important to always use a 3.05 m (10 ft) top width. When clay levees are constructed on pervious foundations, the bottom width may not be adequate to reduce the potential for foundation piping. This can be accomplished by using berms either landward or riverward of the levee. Berm thickness will be site specific. Berms reduce the potential for foundation piping, but do not reduce foundation seepage.

(4) Placement and compaction. As stated above, obtaining proper compaction equipment for a given soil type will be difficult. It is expected in most cases that the only compaction will be from that due to the hauling and spreading equipment; i.e., construction traffic routed over the fill. Levee height should provide 0.61 m (2 ft) of freeboard above forecast flood crest. In urban areas, the upstream end of the project should use a larger freeboard than the downstream end.

(5) Slope protection.

(a) General. Methods of protecting levee slopes from current scour, wave wash, seepage, and debris damage are numerous and varied. However, during a flood emergency, time, availability of materials, cost and construction capability preclude the use of all accepted methods of permanent slope protection. Field personnel must decide the type and extent of slope protection the emergency levee will need. Several methods of protection have been established which prove highly effective in an emergency. Again, resourcefulness on the part of the field personnel may be necessary for success.

(b) Polyethylene and sandbags. Experience has shown that a combination of polyethylene (poly) and sandbags is one of the most expedient, effective, and economical methods of combating slope attack in a flood situation. Poly and sandbags can be used in a variety of combinations, and time becomes the factor that may determine which combination to use. Ideally, poly and sandbag protection should be placed in the dry. However, many cases of unexpected slope attack will occur during high water, and a method for placement in the wet is covered below. See Figures F-1 to F-4 for suggested methods of laying poly and sandbags. Since each flood fight project is generally unique (river, personnel available, materials, etc.), specific details of placement and materials handling will not be covered. Personnel must be aware of resources available when using poly and sandbags.

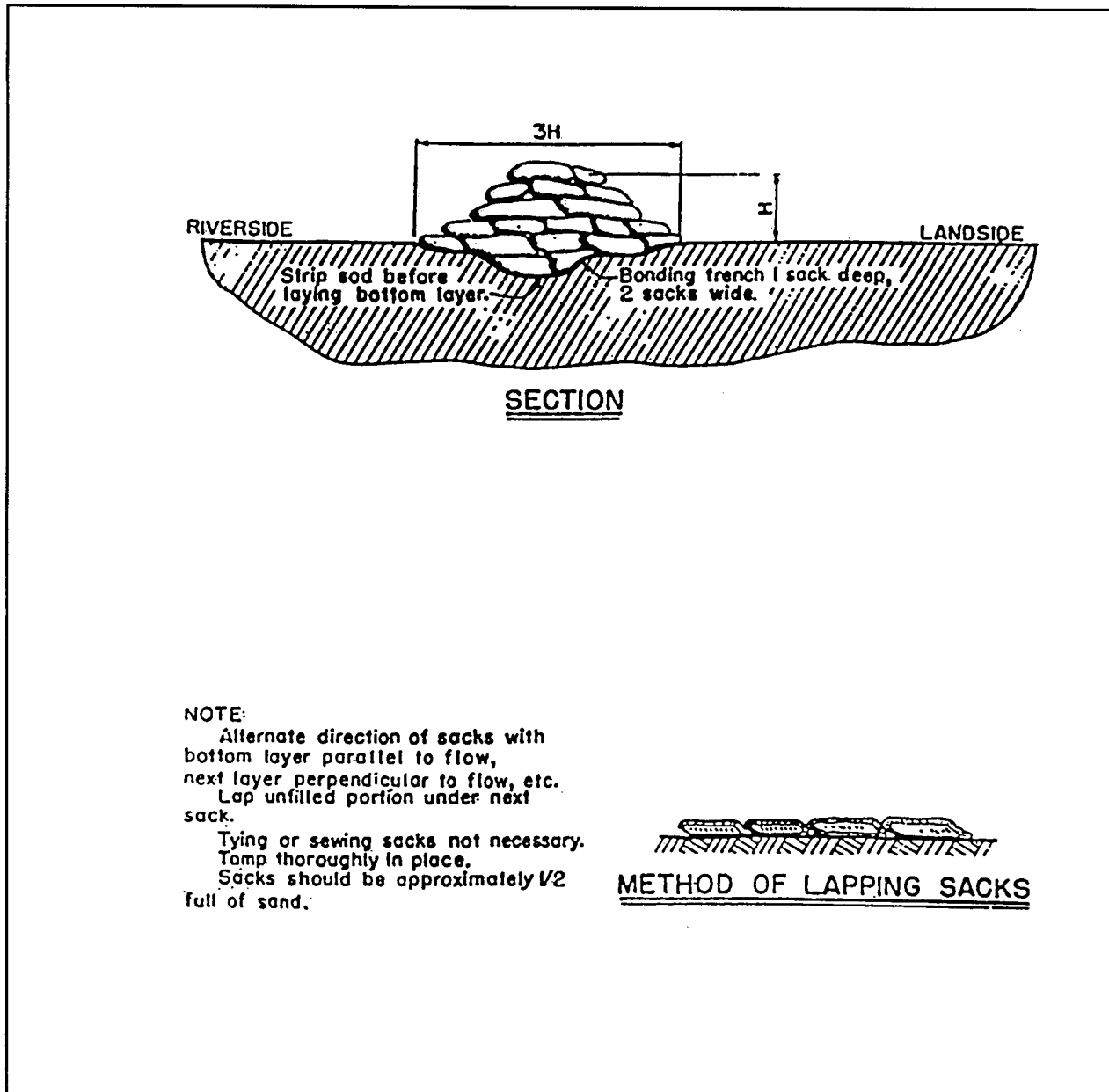

Figure F-1. Sandbag barrier

(c) Toe anchorage and poly placement. Anchoring the poly along the riverward toe is important for a successful job. It may be done in three different ways: (1) After completion of the levee, a trench excavated along the toe, poly placed in the trench, and the trench backfilled; (2) Poly placed flat-out away from the toe, and earth pushed over the flap; and (3) Poly placed flat-out from the toe and one or more rows of sandbags placed over the flap. The poly should then be unrolled up the slope and over the top enough to allow for anchoring with sandbags. Poly should be placed from downstream to upstream along the slopes and overlapped at least 0.61 m (2 ft). The poly is now ready for the "hold-down" sandbags.

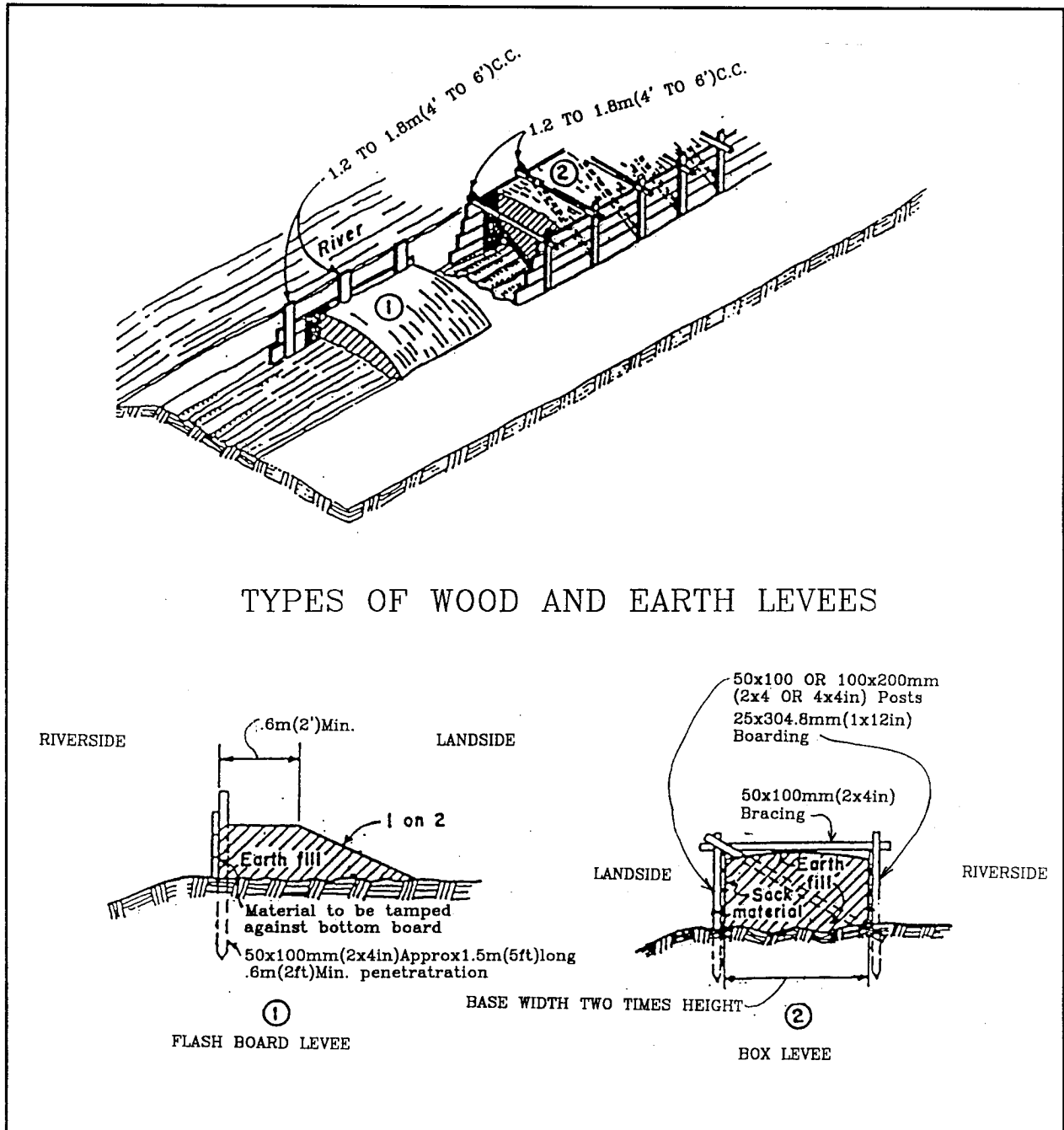

Figure F-2. Flash board and box levee

(d) Slope anchorage. It is mandatory that poly placed on levee slopes be held down. An effective method of anchoring poly is a grid system of sandbags, unless extremely high velocities, heavy debris, or a large amount of ice is anticipated. Then a solid blanket of bags over the poly should be used. A grid system can be constructed faster and requires fewer bags and much less labor than a total covering. Various grid systems include vertical rows of lapped bags, two-by-four lumber held down by attached bags, and rows

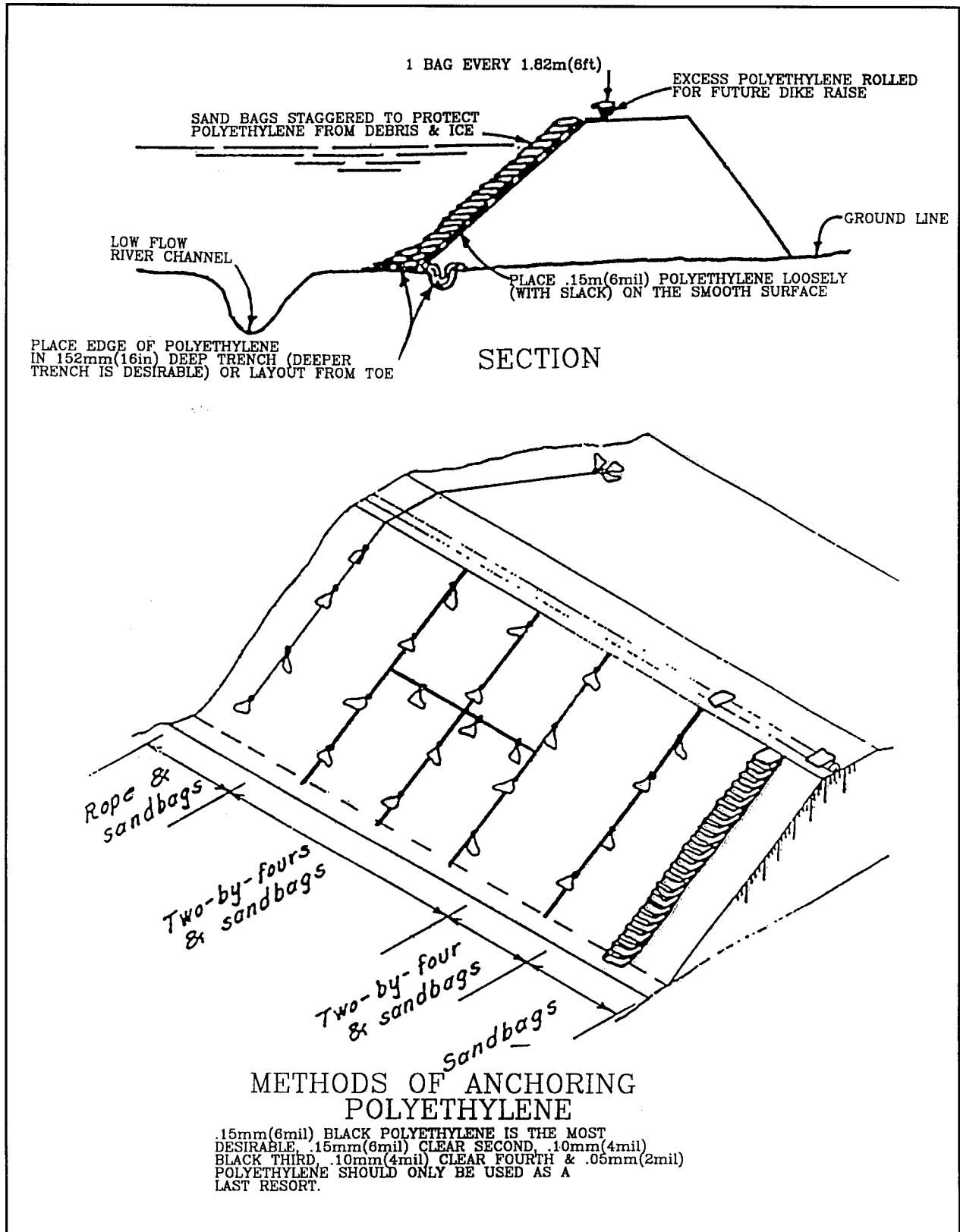

Figure F-3. Placement of polyethylene sheeting on temporary levee

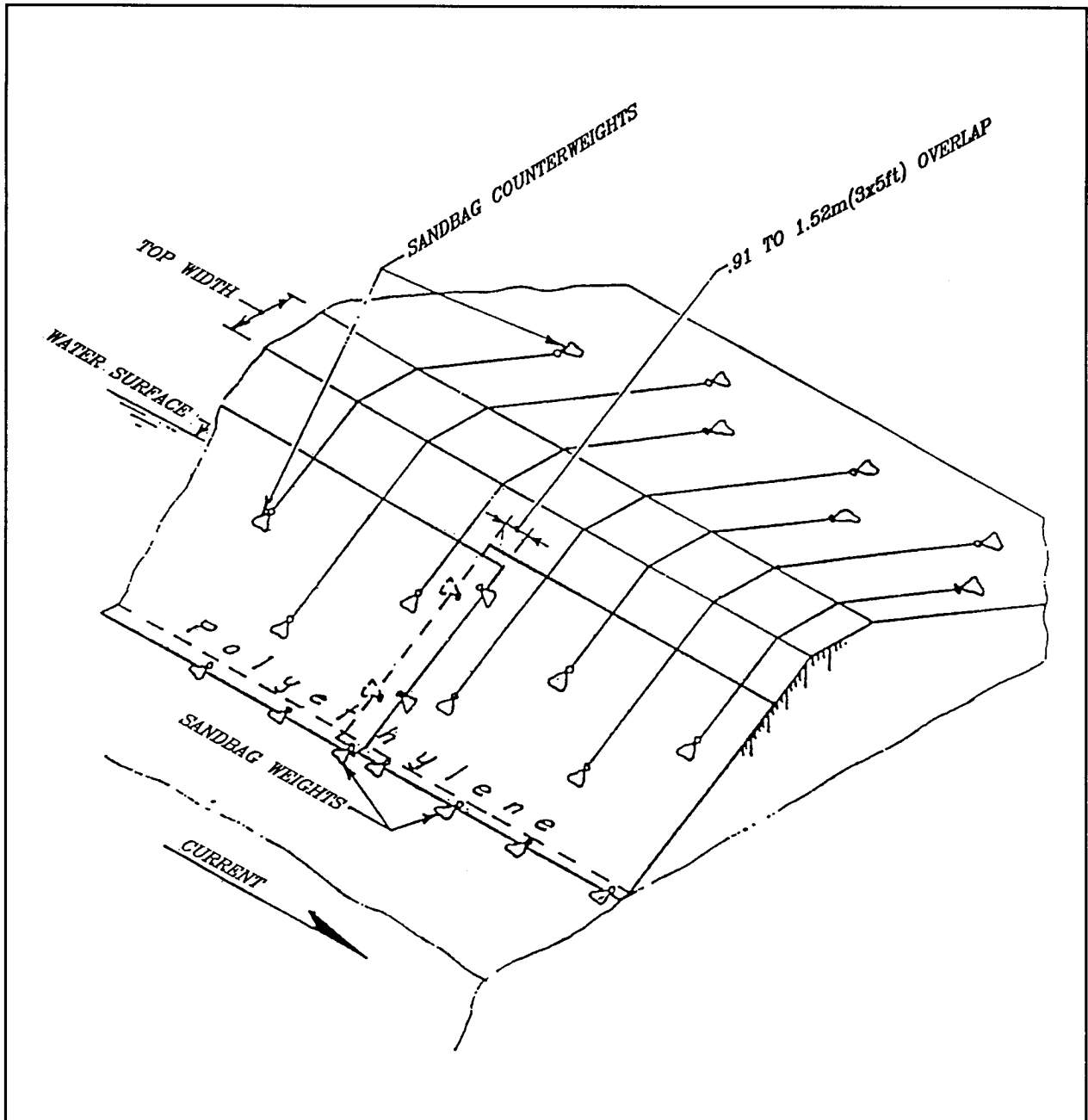

Figure F-4. Placement of polyethylene sheeting in the wet

of bags held by a continuous rope tied to each bag. Poly can also be held down by a system using two bags tied with rope and the rope saddled over the levee crown with a bag on each slope.

(e) Placement in the wet. In many situations during high water, poly and sandbags placed in the wet must provide the emergency protection. Wet placement may also be required to replace or maintain damaged poly or poly displaced by current action. Figure F-4 shows a typical section of levee covered in the wet. Sandbag anchors are formed at the bottom edge and ends of the poly by bunching the poly around

a fistful of hand or rock and tying the sandbags to this fist-sized ball. Counterweights consisting of two or more sandbags connected by a length of 6.35-mm (1/4-in.) rope are used to hold the center portion of the poly down. The number of counterweights will depend on the uniformity of the levee slope and current velocity. Placement of the poly consists of first casting out the poly sheet with the bottom weights and then adding counterweights to slowly sink the poly sheet into place. The poly, in most cases, will continue to move down slope until the bottom edge reaches the toe of the slope. Sufficient counterweights should be added to insure that no air voids exist between the poly and the levee face and to keep the poly from flapping or being carried away in the current. For this reason, it is important to have enough counterweights prepared prior to the placement of the sheet.

(f) Overuse of poly. In past floods there has been a tendency to overuse and in some cases misuse poly on slopes. For example, on well compacted clay embankments, in areas of relatively low velocities, use of poly would be unnecessary. Also, placement of poly on landward slopes to prevent seepage must not be done. It will only force seepage to another exit and may prove detrimental. Poly has been used on the landside slope of levees to prevent rainwater from entering a crack where slope movement has occurred, particularly in fat clay soils. Keeping water out of the cracks resulting from slope movements is desirable to prevent lubrication and additional hydrostatic pressure on the slip surface.

(g) Riprap. Riprap is a positive means of providing slope protection and has been used in a few cases where erosive forces were too large to effectively control by other means. Objections to using riprap when flood fighting are: (1) rather costly; (2) large amount necessary to protect a given area; (3) availability; and (4) little control over its placement, particularly in the wet.

(h) Groins. In the past, small groins, extending 3.05 m (10 ft) or more into the channel were effective in deflecting current away from the levees. Groins can be constructed by using sandbags, snow fence, rock, compacted earth, or any other substantial materials that are available. Preferably groins should be placed in the dry and at locations where severe scour may be anticipated. Consideration of the hydraulic aspects of placing groins should be given, because haphazard placement may be detrimental. Hydraulic technical assistance should be sought if doubts arise in the use of groins. Construction of groins during high water will be very difficult and results will generally be minimal. If something other than compacted fill is used, some form of anchorage or bonding should be provided. (For example, snow fence anchored to a tree beyond the toe of the levee.)

(i) Log booms. Log booms have been used to protect levee slopes from debris or ice attack. Logs are cabled together and anchored with a dead man in the levee. The boom will float out in the current and, depending on log size, will deflect floating objects.

(j) Miscellaneous measures. Several other methods of slope protection have been used. Straw bales pegged into the slope may be successful against wave action, as is straw spread on the slope and overlain with snow fence.

(6) Sandbag dikes. The sandbag dike should not be considered as a primary-flood barrier. The main objections to their use are that the materials (bags and sand) are quite costly; they require a tremendous amount of manpower; and are time consuming to construct. They are also very difficult to raise if the flood forecasts are revised. Sandbag dikes should be used where a very low and relatively short barrier is required and earth fill would not be practicable, such as in the freeboard range along an arterial street. They are very useful in constricted areas such as around or very close to buildings, where rights-of-way would preclude using earth fill. They are also useful where temporary closure is required, such as roads and railroad tracks. A polyethylene seepage barrier should be incorporated into the sandbag structure. The poly must be on the riverward slope and brought up immediately behind the outermost layer of bags. The poly should be

keyed-in to a trench at the toe and anchored, or, at best, lapped under the sandbags for anchorage. See Figure F-1 for recommended practices in sandbag dike construction. A few points to be aware of in sandbag construction are: (1) sand, or predominantly sandy or gravelly material should be used; (2) extremely fine, clean sand, such as washed mortar sand, should be avoided; (3) bags should be 1/2 full; (4) bags should be lapped when placing; (5) bags should be tamped tightly in place; and (6) the base width should be wide enough to resist the head at high water. Sandbagging is also practical for raising a narrow levee, or when construction equipment cannot be used. Sandbag raises should be limited to 0.91 m (3 ft), if possible.

(7) Miscellaneous flood barriers. In addition to earth fill and sandbag levees, two other types of flood barriers should be mentioned. They are the flashboard and the box levees, both of which are constructed using lumber and earth fill (see Figure F-2). They may be used for capping a levee or as a barrier in highly constricted areas. Two disadvantages in using these barriers are the long construction time involved and very high cost. Therefore, these barriers are not recommended, unless a very unusual situation warrants their use.

F-3. Emergency Interior Drainage Treatment

a. General. High river stages often disrupt the normal drainage of sanitary and storm sewer systems, render sewage treatment plants inoperative, and cause backup in sewers and the discharge of untreated sewage directly into the river. When the river recedes, some of the sewage may be trapped in low lying pockets to remain as a possible source of contamination. Hastily constructed dikes intended to keep out river waters may also seal off normal outlet channels for local runoff, creating large ponds on the landward side of the dikes, making the levees vulnerable from both sides. If the ponding is excessive, it may nullify the protection afforded by the dikes even if they are not overtopped. Sewers may also back up because of this ponding.

b. Preliminary work. In order to arrive at a reasonable plan for interior drainage treatment, several items of information must be obtained by field personnel. These are:

- (1) Size of drainage area.
- (2) Pumping capacity and/or ponding required.
- (3) Basic plan for treatment.
- (4) Storm and sanitary sewer and water line maps, if available.
- (5) Location of sewer outfalls (abandoned or in use).
- (6) Inventory of available local pumping facilities.
- (7) Probable location of pumping equipment.
- (8) Whether additional ditching is necessary to drain surface runoff to ponding and/or pump locations.
- (9) Location of septic tanks and drain fields (abandoned or in use).

c. *Pumps, types, sizes, and capacities.*

(1) Storm sewer pumps. Table F-1 indicates the size of pump needed to handle the full flow discharge from sewer pipes up to 610 mm (24 in.) in diameter. Table F-2 shows sizes and capacities of agricultural--type pumps which may be useful in ponding areas.

Table F-1
Matching Pipe Size to Pump Size

Sewer Pipe Size, mm (in.)	Probable Required Pump Size, mm (in.)
152.4 (6)	50.8 (2)
203.2 (8)	50.8 to 76.2 (2 to 3)
254.0 (10)	76.2 to 101.6 (3 to 4)
304.8 (12)	101.6 to 152.4 (4 to 6)
381.0 (15)	152.4 to 203.2 (6 to 8)
457.2 (18)	152.4 to 254 (6 to 10)
533.4 (21)	203.2 to 254 (8 to 10)
609.6 (24)	254 to 304.8 (10 to 12)

(2) Fire engine pumps. The ordinary fire pumper has a 101.6 mm (4-in.) suction connection and a pumping capacity of about 2838.75 ℓ /min (750 gpm). Use only if absolutely necessary.

(3) Pump discharge piping. The Crisafulli pumps are generally supplied with 15.24-m (50-ft) lengths of butyl rubber hose. Care must be taken to prevent damage to the hose. Irrigation pipe or small diameter culverts will also serve as discharge piping. Care should be taken to extend pump discharge lines riverward far enough to not cause erosion of the levee. On 304.8 mm (12-in.) or larger lines, substantial anchorage is required. These pumps must not be operated on slopes greater than 20 degrees from horizontal.

(4) Sanitary sewage pumping. During high water, increased infiltration into sanitary sewers may necessitate increased pumping at the sewage treatment plant or at manholes at various locations to keep the system functioning. To estimate the quantity of sewage, allow 0.378 m^3 (100 gal) per capita per day for sanitary sewage and an infiltration allowance of 35.28 m^3 per km-day (15,000 g/mile-day) of sewer per day. In some cases, it will be necessary to pump the entire amount of sewage, and in other cases only the added infiltration will have to be pumped to keep a system in operation.

Example: Estimate pumping capacity required at an emergency pumping station to be set up at the first manhole above the sewage treatment plant for a city of 5,000 population and approximately 48.24 km (30 miles) of sewer (estimated from map of city). In this case, it is assumed that the treatment plant will not operate at all.

$$\text{Required capacity} = (\text{infiltration}) + (\text{sewage})$$

$$\text{Sewage demand: } \frac{5000 \text{ per} \times 0.378 \text{ m}^3/\text{person/day}}{24 \text{ hr} \times 60 \text{ min}} = 1.314 \text{ m}^3/\text{min}$$

$$\frac{5000 \text{ persons} \times 100 \text{ gal/person/day}}{24 \text{ hr} \times 60 \text{ min/hr}} = 347 \text{ gpm}$$

Table F-2
Crisafulli Pumps - Model CP 2 in. to 24 in.

Size mm (in.)	m ³ /min (gal/min)	Head ^a m (ft)	Elec. kW (hp)	Gas or Diesel kW (hp)
50.8 (2)	0.56 (150)		0.745 (1)	
101.6 (4)	1.88 (500)		5.59 (7.5)	11.18(15)
152.4 (6)	3.76 (1000)		7.45 (10)	14.9 (20)
203.2 (8)	11.27 (3000)	3.04 (10)	11.18 (15)	18.62(25)
304.8 (12)	18.79 (5000)		18.62 (25)	29.8 (40)
406.4 (16)	35.70 (9500)		29.8 (40)	48.4 (65)
609.6 (24)	93.95 (25000)		55.88 (75)	104.3(140)
50.8 (2)	0.49 (130)		0.745 (1)	
101.6 (4)	1.84 (490)		7.45 (10)	14.9 (20)
152.4 (6)	3.19 (850)		11.18 (15)	18.62(25)
203.2 (8)	9.21 (2450)	6.1 (20)	14.9 (20)	26.08(35)
304.8 (12)	14.09 (3750)		22.35 (30)	37.2 (50)
406.4 (16)	30.06 (8000)		33.52 (45)	63.3 (85)
609.6 (24)	71.4 (19000)		74.5 (100)	141.6(190)
50.8 (2)	0.45 (120)		0.745 (1)	
101.6 (4)	1.79 (475)		8.94 (12)	18.62(25)
152.4 (6)	2.99 (795)		14.9 (20)	26.08(35)
203.2 (8)	8.08 (2150)	9.84 (30)	18.62 (25)	33.52(45)
304.8 (12)	12.96 (3450)		26.08 (35)	52.15(70)
406.4 (16)	26.68 (7100)		44.70 (60)	93.12(125)
609.6 (24)	62.38 (16600)		93.12 (125)	186.24(250)

^a Use high head pumps for heads over 6.1 m or 59.71 kPa (20 ft).

$$\text{Infiltration: } \frac{35.31 \text{ m}^3}{\text{km}} \times 48.24 \text{ km} \frac{1}{24 \text{ hr} \times 60 \text{ min}} = 1.18 \text{ m}^3/\text{min}$$

$$\frac{15000 \text{ gal/mile/day} \times 30 \text{ miles}}{24 \text{ hr} \times 60 \text{ min/hr}} = 312 \text{ gpm}$$

Required pumping capacity: 2.49 m³/min (659 gpm). From Table F-3, use one 101.6 mm (4-in.) pump or its equivalent.

Table F-3
Marlow Self Priming Centrifugal Pumps

Size mm (in.)	AGC Rating ^a	Capacity ^b m ³ /min (gal/min)	Horsepower kW (hp)
38.1 (1.5)	4M	0.25 (67)	1.34 (1.8)
50.8 (2)	7-10M	0.44-0.63 (117-167)	1.71-3.66(2.3-4.9)
76.2 (3)	20-30M	1.26-1.89 (334-500)	3.66-8.36 (4.9-11.2)
101.6 (4)	30-40M	1.89-2.51 (500-665)	14.92-28.94 (20-38.8)
152.4 (6)	90M	5.67 (1500)	32.46 (43.5)
203.2 (8)	125M	7.87 (2080)	46.25 (62)
254.0 (10)		12.6 (3330)	46.25 (62)

^a Gallons per hour, thousands.

^b At 75 kPa (7.67-m, 25-ft) head.

d. Metal culverts.

(1) Pumping of ponded water is usually preferable to draining the water through a culvert since the tailwater (drainage end of culvert) could increase in elevation to a point higher than the inlet, and water could back up into the area being protected. Installation of a flapgate at the outlet end may be desirable to minimize backup.

(2) Table F-4 shows the capacity of corrugated pipe culverts on a flat slope, with H factor (head) representing the difference between the headwater level and tailwater level, assuming the outlet is submerged. If the outlet is not submerged the head equals the difference in elevation between the headwater level and 0.6 of the diameter of the pipe measured from the bottom of the pipe upward. The capacity would change for smooth pipe, pipe laid on a slope, or if headwalls or wingwalls are used.

(3) If a culvert is desired to pass water from a creek through a levee, a computation of the drainage basin by an engineer is required to determine pipe size.

e. Preventing backflow in sewer lines.

(1) Watertight sluice gates or flap gates are one answer. Emergency stoppers may be constructed of lumber, sandbags, or other materials, using poly as a seal, preferably placed on the discharge end of the outfall pipe.

(2) Figures F-5 and F-6 contain manufacturer's literature on prefabricated rubber pipe stoppers which can be placed in the outlet opening of a manhole.

(3) Figures F-7 to F-11 illustrate methods of sealing off the outlet openings of a manhole with standard materials which are normally available so that the manhole may be used as an emergency pumping station.

F-4. Flood Fight Problems

a. General. Problem situations which arise during a flood fight are varied and innumerable. The problems covered below and in "Emergency Interior Drainage Treatment" are those which are considered most critical to the integrity of the flood barrier system. It would be impossible to enumerate all of the problems, such as supplies, personnel, communication, etc., which field personnel must handle. The most valuable asset of field personnel under emergency conditions is their common sense. Many problems can be solved instantly and with less effort through the application of good common sense and human relations. Problems, such as those below, can be identified early only if a well organized levee patrol system with a good communication system exists. The problems are presented with the assumption that high water is on the levee slopes.

b. Overtopping. Overtopping of a levee is the flowing of water over the levee crown. Since most emergency levees are of an urban nature, overtopping should be prevented at any cost. Overtopping will generally be caused by: (1) unusual hydrologic phenomena, including unexpected rainfall, faster than expected rainfall, faster than expected snowmelt, and ice and debris blockages, which cause a much higher stage than anticipated; (2) insufficient time in which to complete the flood barrier; or (3) unexpected settlement of the barrier. Generally, the flood barriers are constructed 0.61 m (2 ft) above the crest prediction. If the crest prediction is raised during construction, additional height must be added to the barrier. Capping should be done with earth fill or sandbags, using normal construction procedures. For levee construction, the 3.05 m (10 ft) top width allows the barrier to be raised relatively quickly with regular

Table F-4a
Capacity of Corrugated Metal Pipe Culverts
Without Headwalls and With Outlet Submerged (outlet control-full flow) (Circular) (metric Units)

Dia. In mm	CUBIC METERS PER SECOND																
	Pipe Pressure in kPa																
	0.003	0.006	0.008	0.011	0.014	0.017	0.023	0.028	0.034	0.040	0.045	0.050	0.056	0.071	0.085	0.1	0.113
304.2	2.98	4.17	5.07	5.96	6.6	7.15	8.34	9.23	10.1	11	11.9	12.5	13.1	14.9	16.1	17.3	18.5
381	5.07	7.15	8.64	10.13	11.3	12.2	14.3	15.8	17.3	18.8	20.3	21.2	22.4	25	27.4	29.5	32.8
457.2	7.75	10.73	13.11	15.5	17	18.5	21.5	23.8	26.2	28.3	29.8	32.8	32.8	38.7	41.7	44.7	47.7
533.4	10.7	15.2	18.5	21.4	23.8	26.2	29.8	32.8	35.8	38.7	41.7	44.7	47.7	53.6	56.6	62.6	65.6
609.6	14.6	20.3	25	28.6	32.8	35.8	41.7	44.7	50.7	53.6	56.6	59.6	62.6	71.5	77.5	83.4	89.4
685.8	18.5	26.2	32.8	35.8	41.7	44.7	53.6	60	62.6	68.5	74.5	77.5	83.1	92.3	101	107	116
762.0	23.2	32.8	41.7	47.7	50.7	56.6	65.6	74.5	80.5	86.4	95.4	98.3	98	116	125	137	146
914.4	35.8	47.7	59.6	68.5	77.5	83.4	98.3	110	119.2	128.1	137	146	155	170	188	203	215
1066.8	47.7	68.5	83.4	95.4	107.2	116.2	134.1	152	164	178.8	191	203	212	235	256	277	298
1238.4	65.6	89.4	110	128	143	155	179	203	221	238.4	253	268	280	316	349	373	399
1371.6	83.4	116.2	143	164	181.8	200	232	260	289	304	325	346	361	405	444	477	510
1524	101	143	175	203	226.5	247	286	319	352	375	400	423	447	498	542	587	626

Dia. In mm	CUBIC METERS PER SECOND																
	Pipe Pressure in kPa																
	0.003	0.006	0.008	0.011	0.014	0.017	0.023	0.028	0.034	0.040	0.045	0.050	0.056	0.071	0.085	0.100	0.113
304.2	2.38	3.27	4.17	4.8	5.4	6	6.9	7.5	8.3	8.9	9.5	10.1	10.7	11.9	13.1	14.3	15.2
381	4.17	5.66	7.15	8.05	9.24	10.1	11.6	12.8	14.3	15.5	16.4	17.6	18.5	20.6	22.6	24.4	26.2
457.2	6.26	8.94	11	12.8	14.3	15.5	17.9	20.3	22	23.8	25.6	26.8	28.6	32.8	35.7	38.7	41.7
533.4	8.94	12.8	15.8	18.2	20.3	22.1	25.6	28.6	32.8	35.8	35.8	38.7	42	44.7	50.7	53.6	56.6
609.6	12.5	17.6	21.5	25	28	29.8	35.8	38.7	44.7	47.7	51	53.6	57	62.6	68.5	74.5	80.5
685.8	16.4	23.2	28.6	32.8	35.8	41.7	47.7	51	56.6	62.6	66	68.6	74.5	83	89.4	98.3	104
762.0	20.9	29.2	35.8	41.7	47.7	50.7	60	66	71.5	77.5	83	89.4	92	104	113	125	131
914.4	29.8	44.7	53.6	62.6	71.5	77.5	89.4	98	107	116	125	134	140	158	173	185	197
1066.8	44.7	62.6	77.5	89.4	98.3	107	125	140	152	164	175	185	197	221	238	262	277
1238.4	59.6	83.4	104.3	119.2	134	146	167	188	206	220	238	250	265	295	25	352	378
1371.6	77.5	107.3	134.1	152	170	188	215	241	265	286	307	325	343	381	417	453	486
1524	95	134.1	164	191	215	232	268	298	328	358	381	405	426	477	522	566	602

Dia. In mm	CUBIC METERS PER SECOND																
	Pipe Pressure in kPa																
	0.003	0.006	0.008	0.011	0.014	0.017	0.023	0.028	0.034	0.040	0.045	0.050	0.056	0.071	0.085	0.100	0.113
304.2	2.09	2.98	3.6	4.17	4.77	5.07	5.96	6.56	7.15	7.75	8.12	8.64	9.24	10.4	11.3	12.2	13.11
381	3.58	5.07	6.3	7.15	8.05	8.94	10.1	11.3	12.5	13.4	14.3	15.2	16.1	17.9	19.7	21.2	22.6
457.2	5.66	8.05	9.8	11.3	12.5	13.7	15.8	17.6	19.4	20.9	22.3	23.8	25	27.7	29.8	32.8	35.8
533.4	8.05	11.6	14.3	16.4	18.2	19.7	22.9	25.9	28.3	29.8	32.8	35.8	35.8	41.7	44.7	47.7	50.7
609.6	11.3	16.1	19.7	22.6	25	27.4	32.8	35.8	38.7	41.7	44.7	47.7	50.7	56.6	65.6	65.6	71.5
685.8	14.9	21.1	25.9	29.8	33	35.8	41.7	47.7	50.7	56.6	59.6	62.6	65.6	74.5	80.5	86.4	92.4
762.0	19.1	26.8	32.8	38.7	42	47.7	53.6	59.6	66	68.5	74.5	80.5	83.4	95.4	104	110	119
914.4	28.9	41.7	50.7	56.6	65.6	71.5	80.5	92.4	98.3	107	113	122	128	143	155	167	179
1066.8	41.7	56.6	72	83.4	92.3	101	116	131	143	152	164	173	182	203	221	238	256
1238.4	56.6	80.5	95	113	125	137	158	176	191	206	221	232	244	274	298	322	346
1371.6	71.5	101	125	143	161	175	203	229	247	268	286	304	322	358	390	423	453
1524	92.3	128	158	182	203	221	256	289	313	337	358	381	402	447	495	530	566

Table F-4b
Capacity of Corrugated Metal Pipe Culverts
Without Headwalls and With Outlet Submerged (outlet control-full flow) (Circular) (Metric Units)

Dia. In m	m ³ PER SECOND																
	Head on Pipe in m																
	0.003	0.006	0.008	0.011	0.014	0.017	0.023	0.028	0.034	0.040	0.045	0.051	0.057	0.071	0.085	0.099	0.113
0.305	0.3	0.43	0.53	0.61	0.67	0.73	0.85	0.94	1.04	1.13	1.22	1.28	1.34	1.52	1.64	1.77	1.88
0.381	0.52	0.73	0.88	1.04	1.16	1.25	1.46	1.61	1.77	1.92	2.07	2.16	2.29	2.56	2.8	3.02	3.35
0.457	0.79	1.1	1.34	1.58	1.74	1.89	2.19	2.44	2.68	2.9	3.05	3.35	3.35	3.96	4.27	4.57	4.88
0.533	1.10	1.55	1.89	2.19	2.44	2.68	3.05	3.35	3.66	3.96	4.27	4.57	4.88	5.49	5.79	6.4	6.71
0.610	1.49	2.07	2.56	2.93	3.35	3.66	4.27	4.57	5.18	5.49	5.79	6.1	6.4	7.32	7.92	8.53	9.14
0.686	1.89	2.68	3.35	3.66	4.27	4.57	5.49	6.1	6.4	7.01	7.62	7.92	8.53	9.45	10.36	10.79	11.89
0.762	2.38	3.35	4.27	4.88	5.18	5.79	6.7	7.62	8.23	8.84	9.75	10.06	10.7	11.89	12.8	14.02	14.94
0.914	3.66	4.88	6.1	7.01	7.92	8.53	10.06	11.28	12.19	13.11	14.02	14.94	15.85	17.37	19.2	20.72	21.95
1.067	4.88	7.01	8.53	9.77	10.79	11.89	13.72	15.54	16.76	18.29	19.5	20.73	21.64	24.07	26.21	28.35	30.48
1.219	6.71	9.14	11.28	13.11	14.63	15.84	18.29	20.73	22.56	24.38	25.9	27.42	28.65	32.31	35.66	38.1	40.84
1.372	8.53	11.89	14.63	16.76	18.59	20.42	23.72	26.52	29.52	31.09	33.22	35.36	36.88	41.45	45.41	48.77	52.12
1.524	10.36	14.63	17.98	20.73	23.16	25.30	24.26	32.61	35.97	38.4	40.89	3.28	45.72	50.9	55.47	60.04	64.0

Dia. In m	m ³ PER SECOND																
	Head on Pipe in m																
	0.003	0.006	0.008	0.011	0.014	0.017	0.023	0.028	0.034	0.040	0.045	0.051	0.057	0.071	0.085	0.099	0.113
0.305	0.26	0.34	0.43	0.49	0.55	0.61	0.70	0.76	0.85	0.91	0.97	1.04	1.1	1.22	1.34	1.46	1.55
0.381	0.43	0.58	0.73	0.82	0.94	1.04	1.19	1.31	1.46	1.58	1.68	1.8	1.89	2.10	2.32	2.5	2.68
0.457	0.64	0.91	1.13	1.31	1.46	1.58	1.83	2.07	2.26	2.44	2.62	2.74	2.93	3.35	3.66	3.96	4.27
0.533	0.91	1.31	.61	1.86	2.07	2.26	2.62	2.93	3.35	3.66	3.66	3.96	4.27	4.57	5.18	5.49	5.79
0.610	1.28	1.8	2.19	2.56	2.86	3.05	3.66	3.96	4.57	4.88	5.18	5.49	5.79	6.4	7.01	7.62	8.23
0.686	1.68	2.38	2.93	3.35	3.66	4.27	4.88	5.18	5.79	6.4	6.71	7.01	7.62	8.53	9.14	10.1	10.67
0.762	2.13	2.99	3.66	4.27	4.88	5.18	6.1	6.71	7.32	7.92	8.53	9.14	9.45	10.7	11.58	12.8	13.41
0.914	3.05	4.57	5.49	6.4	7.32	7.92	9.14	10.1	10.79	11.89	12.8	13.72	14.32	16.15	17.68	18.9	20.11
1.067	4.57	6.4	7.92	9.14	10.1	10.97	12.8	14.32	15.54	16.76	17.98	18.9	20.11	22.56	24.36	26.82	28.35
1.219	6.1	8.53	10.69	12.19	13.72	14.94	17.07	18.20	14.69	22.56	24.38	25.6	27.13	30.17	33.22	36.0	38.71
1.372	7.92	10.87	13.72	15.54	17.37	19.20	21.95	24.69	27.13	29.26	31.39	33.22	35.06	39.01	42.67	46.32	49.7
1.524	9.75	13.72	16.76	19.51	21.95	23.77	27.43	30.48	33.53	36.58	39.01	41.45	43.59	48.77	53.34	57.91	61.6

Dia. In m	m ³ PER SECOND																
	Head on Pipe in m																
	0.003	0.006	0.008	0.011	0.014	0.017	0.023	0.028	0.034	0.040	0.045	0.051	0.057	0.071	0.085	0.099	0.113
0.305	0.21	0.3	0.36	0.43	0.49	0.52	0.61	0.67	0.73	0.79	0.85	0.88	0.94	1.07	1.16	1.25	1.34
0.381	0.37	0.52	0.64	0.73	0.82	0.91	1.04	1.16	1.28	1.37	1.46	1.55	1.64	1.83	2.0	2.16	2.32
0.457	0.58	0.82	1.0	1.16	1.28	1.4	1.61	1.8	1.98	2.13	2.29	2.44	2.56	2.83	3.05	3.35	3.66
0.533	0.82	1.19	1.46	1.68	1.86	2.01	2.35	2.65	2.9	3.05	3.35	3.66	3.66	4.27	4.57	4.88	5.18
0.610	1.16	1.65	2.01	2.32	2.56	2.8	3.35	3.66	3.96	4.27	4.57	4.88	5.18	5.79	6.4	6.71	7.32
0.686	1.52	2.16	2.66	3.05	3.35	3.66	4.27	4.88	5.18	5.74	6.1	6.4	6.7	7.62	8.23	8.84	9.45
0.762	1.95	2.74	3.35	3.96	4.26	4.88	5.49	6.1	6.71	7.01	7.62	8.23	8.53	9.75	10.67	11.28	12.14
0.914	2.96	4.27	5.18	5.79	6.7	7.32	8.23	9.45	10.1	10.70	11.58	12.5	13.11	14.63	15.85	17.07	18.29
1.067	4.26	5.79	7.32	8.53	9.45	10.36	11.89	13.41	14.6	15.54	16.76	17.68	18.59	20.73	22.56	24.38	26.21
1.219	5.79	8.23	9.75	11.58	12.8	14.02	16.15	17.98	19.51	14.63	22.56	23.77	25.0	28.04	30.48	32.92	35.36
1.372	7.32	10.36	12.8	14.63	16.45	17.98	20.73	23.47	25.3	27.43	29.26	31.09	32.92	36.58	39.93	43.28	46.33
1.524	9.44	13.11	16.15	18.59	20.73	22.56	26.21	29.57	32.0	34.44	36.58	39.01	41.15	45.72	50.6	54.25	57.91

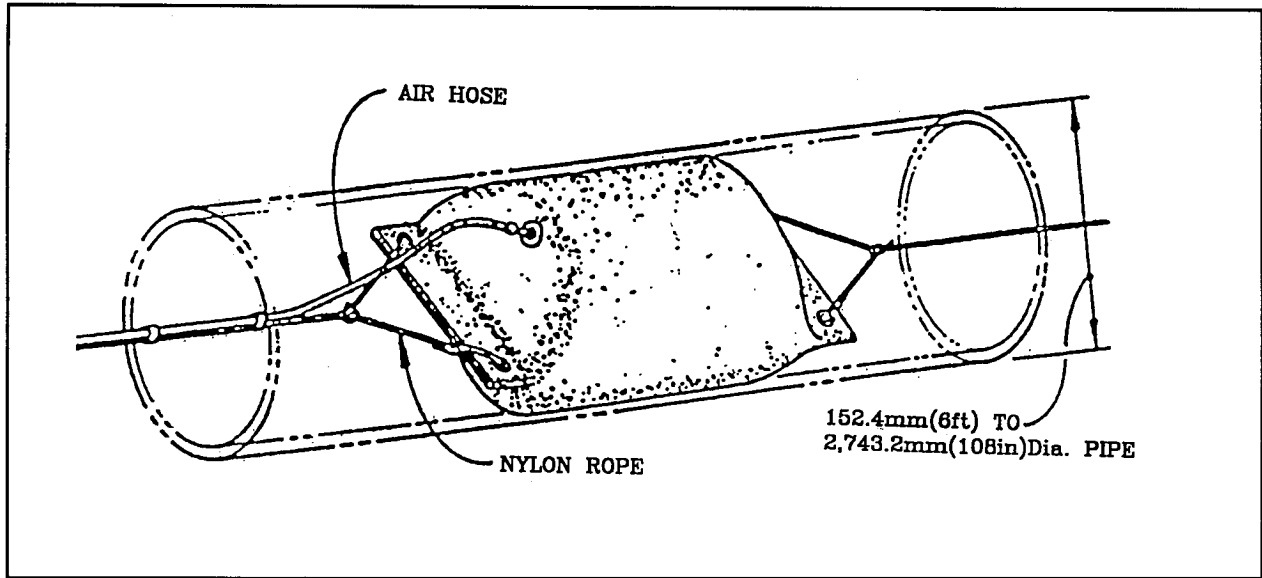

Figure F-5. Prefabricated rubber pipe stoppers for outlet opening of a manhole

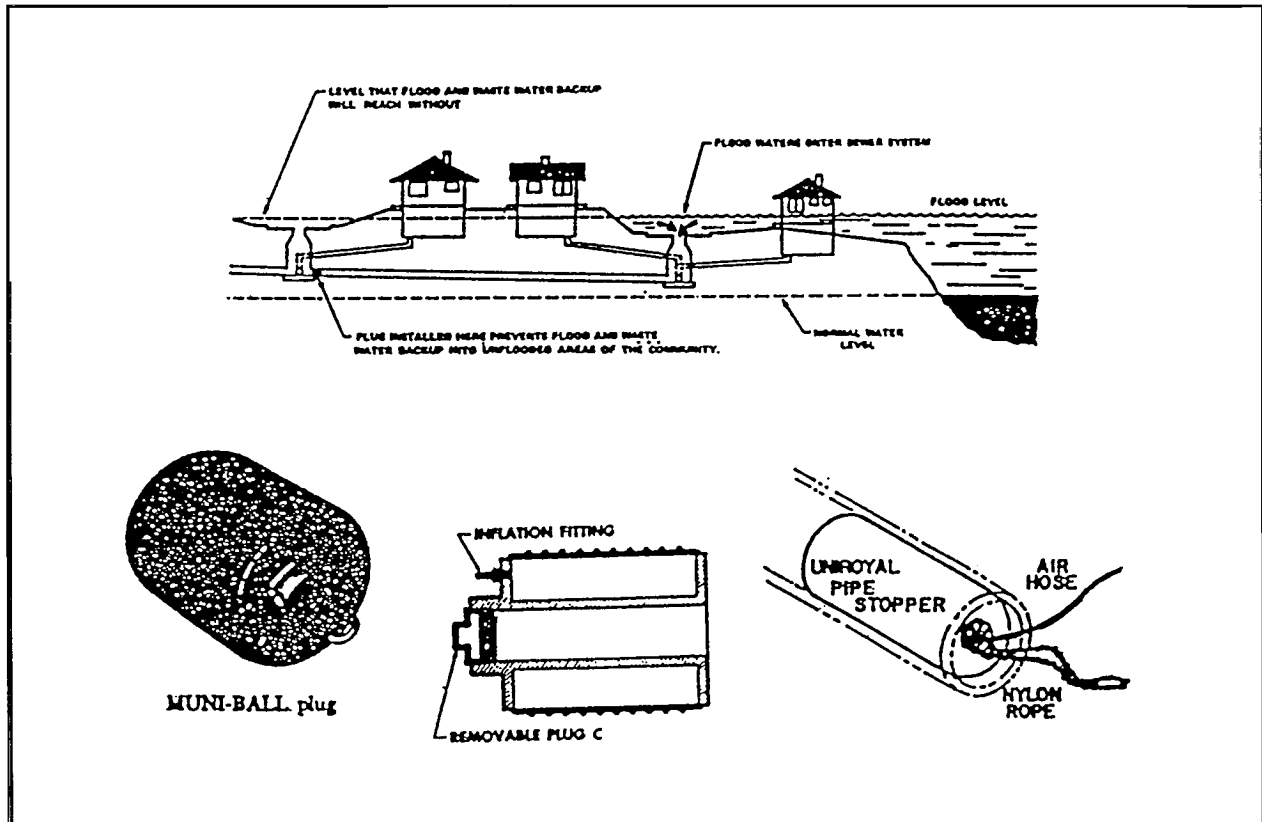

Figure F-6. Prefabricated rubber pipe stoppers for outlet opening of a manhole

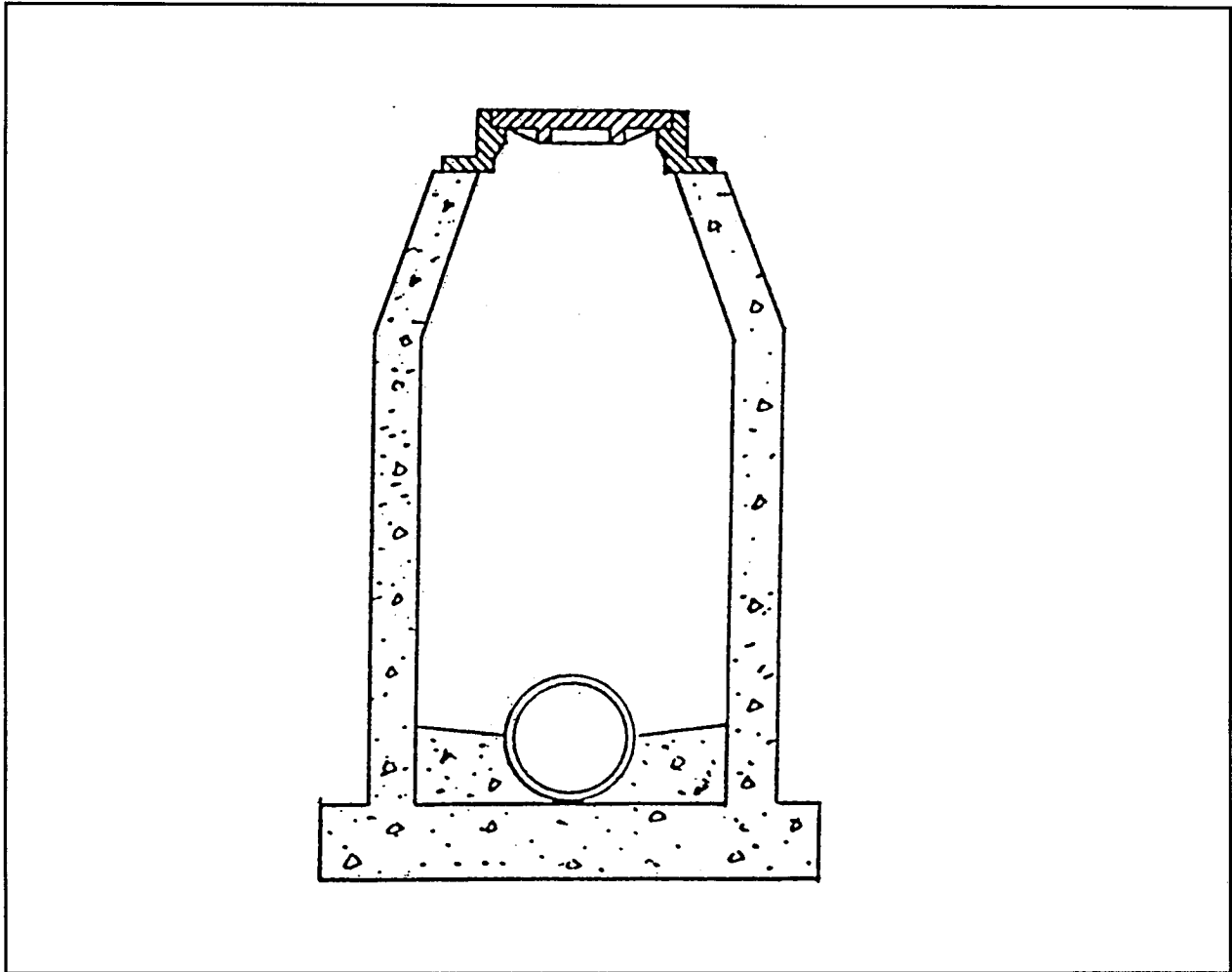

Figure F-7. Typical manhole

construction equipment. However, if the flood barrier consists of poly and sandbags having a minimum top width and limited base width, raising the barrier is very time consuming and labor intensive. Experience has shown that sandbag barriers over 0.91 m (3 ft) in height do not perform well for prolonged floods; underseepage becomes a real problem and failures have occurred as the water approaches the top of protection.

c. Seepage. Seepage is percolation of water through or under a levee, generally appearing first at the landside toe. Seepage through the levee is applicable only to a relatively pervious section. Seepage, as such, is generally not a problem unless (1) the landward levee slope becomes saturated over a large area; (2) seepage water is carrying material from the levee; or (3) pumping capacity is exceeded. Seepage which causes severe sand boils and piping is covered below. Seepage is difficult to eliminate, and attempts to do so may create a much more severe condition. Pumping of seepage should be held to a minimum, based on the maximum ponding elevation without damages. Seepage should be permitted if no apparent ill-effects are observed, and if adequate pumping capacity is available. If seepage causes sloughing of the landward slope, it should be flattened to 1V on 4H or flatter. Material for flattening should be at least as pervious as the embankment material.

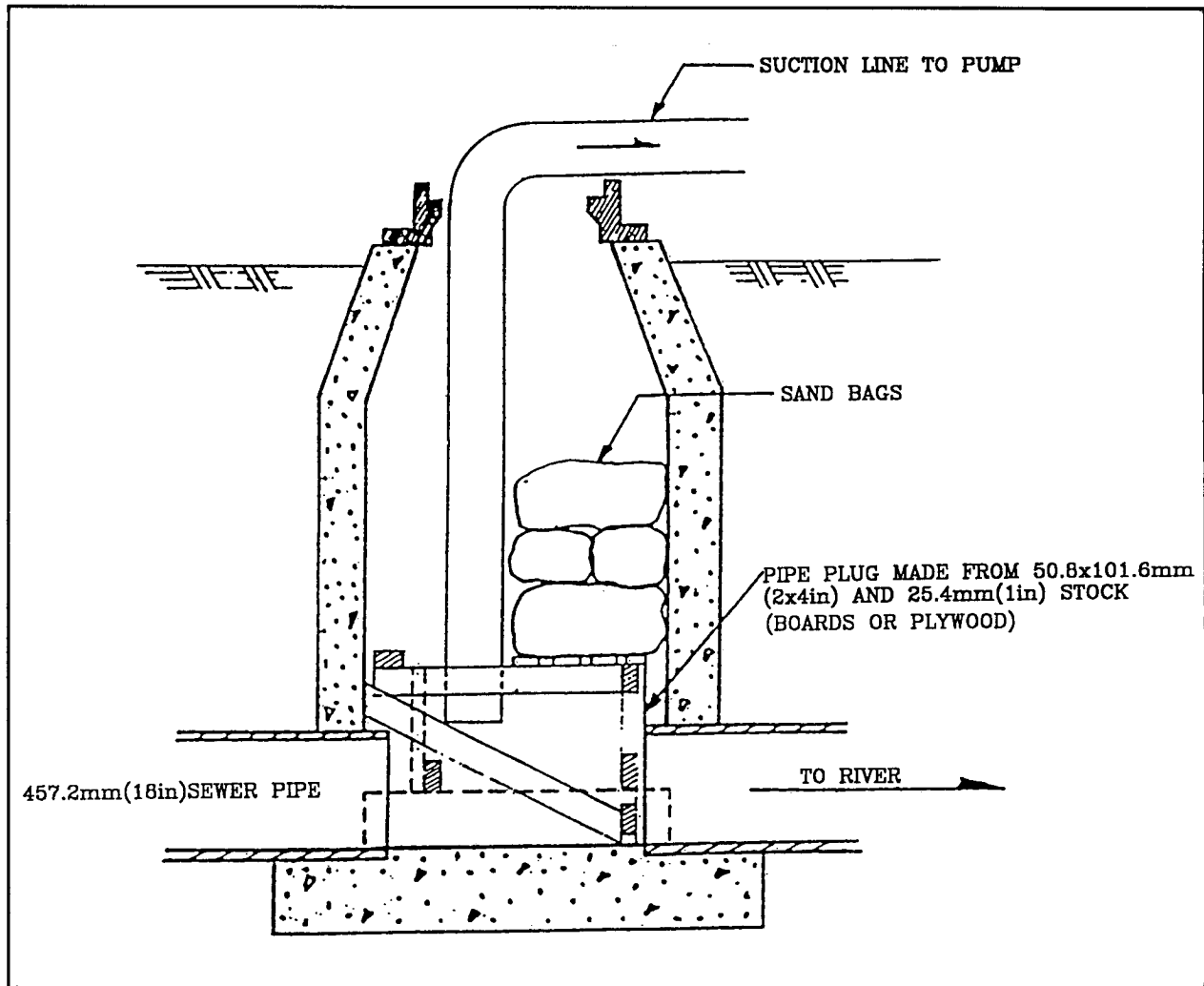

Figure F-8. Adapting manhole for use as emergency pumping station

d. Sand boils.

(1) Description. A sand boil is the rupture of the top foundation stratum landward of a levee caused by excess hydrostatic head in the substratum. Even when a levee is properly constructed and of such mass to resist the destructive action of floodwater, water may seep through a sand or gravel stratum under the levee and break through the ground surface on the landside in the form of bubbling springs. When such eruptions occur, a stream of water bursts through the ground surface, carrying with it a volume of sand or silt which is distributed around the hole. A sand boil may eventually discharge relatively clear water, or the discharge may contain quantities of sand and silt, depending upon the magnitude of pressure and the size of the boil. They usually occur within 3.05 m to 91.4 m (10 to 300 ft) from the landside toe of the levee, and in some instances have occurred up to 304.8 m (1,000 ft) away.

(2) Destructive action. Sand boils can produce three distinctly different effects on a levee, depending upon the condition of flow under the levee.

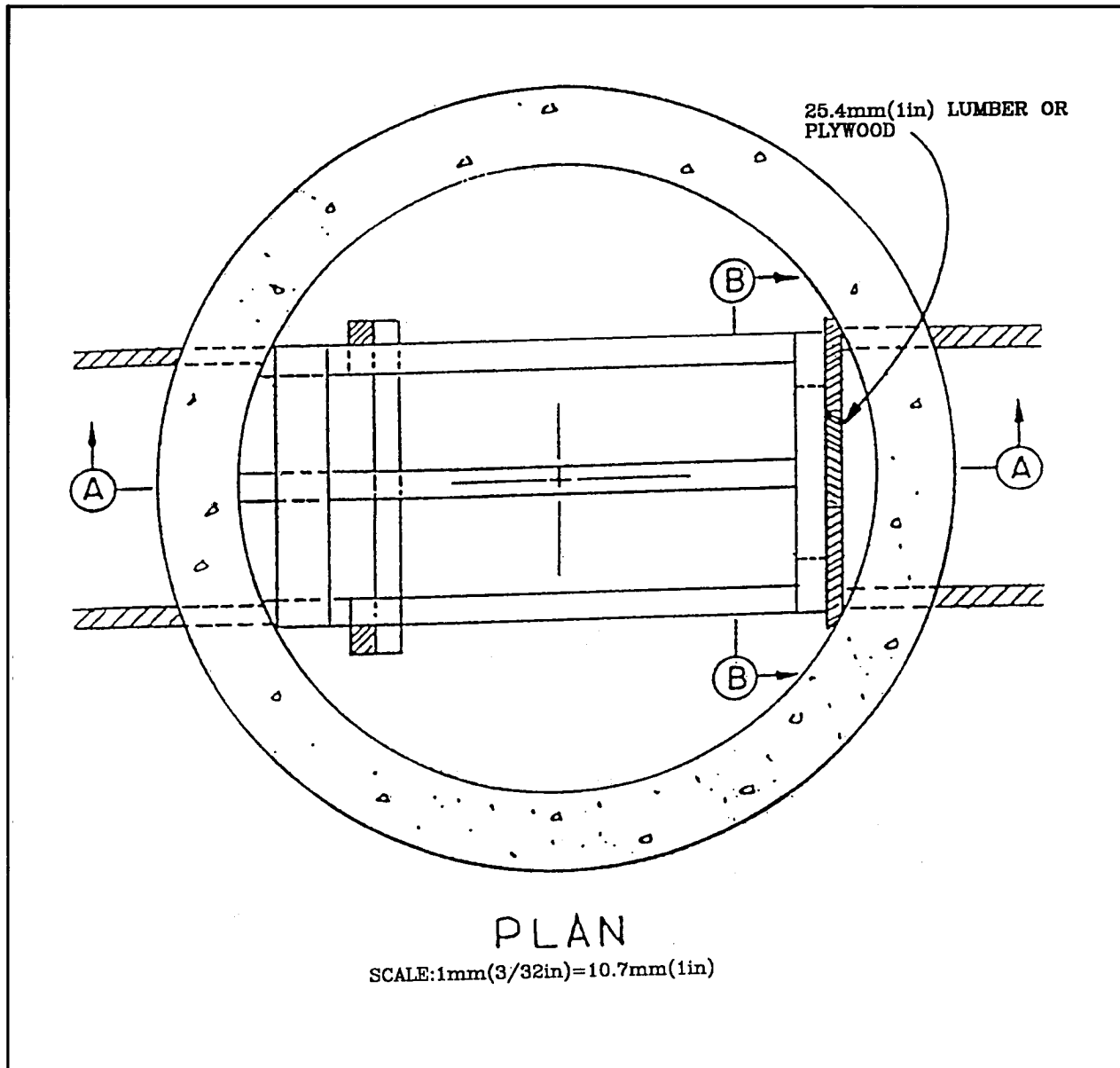

Figure F-9. Sealing top of manhole with wood

(a) Piping flow. Piping is the active erosion of subsurface material as a result of substratum pressure and concentration of seepage in the localized channels. The flow breaks out at the landside toe in the form of one or more large sand boils. Unless checked, this flow causes the development of a cavern under the levee, resulting in the subsidence of the levee and possible overtopping. This case can be easily recognized by the slumping of the levee crown.

(b) Non-piping flow. In this case, the water flows under pressure beneath the levee without following a defined path, as in the case above. This flow results in one or more boils outcropping at or near the landside toe. The flow from these boils tends to undercut and ravel the landside toe, resulting in sloughing

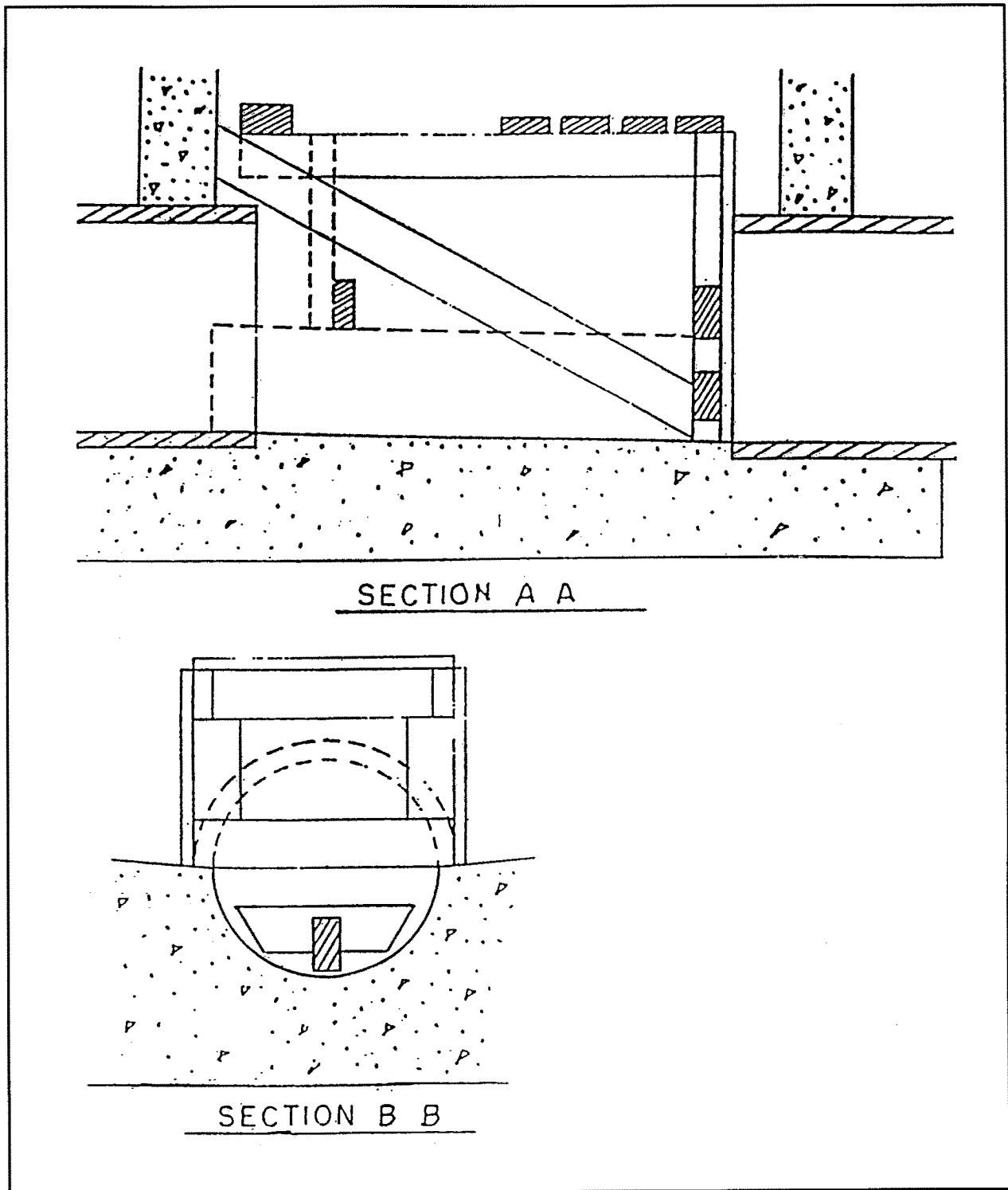

Figure F-10. Treatment of bottom of manhole

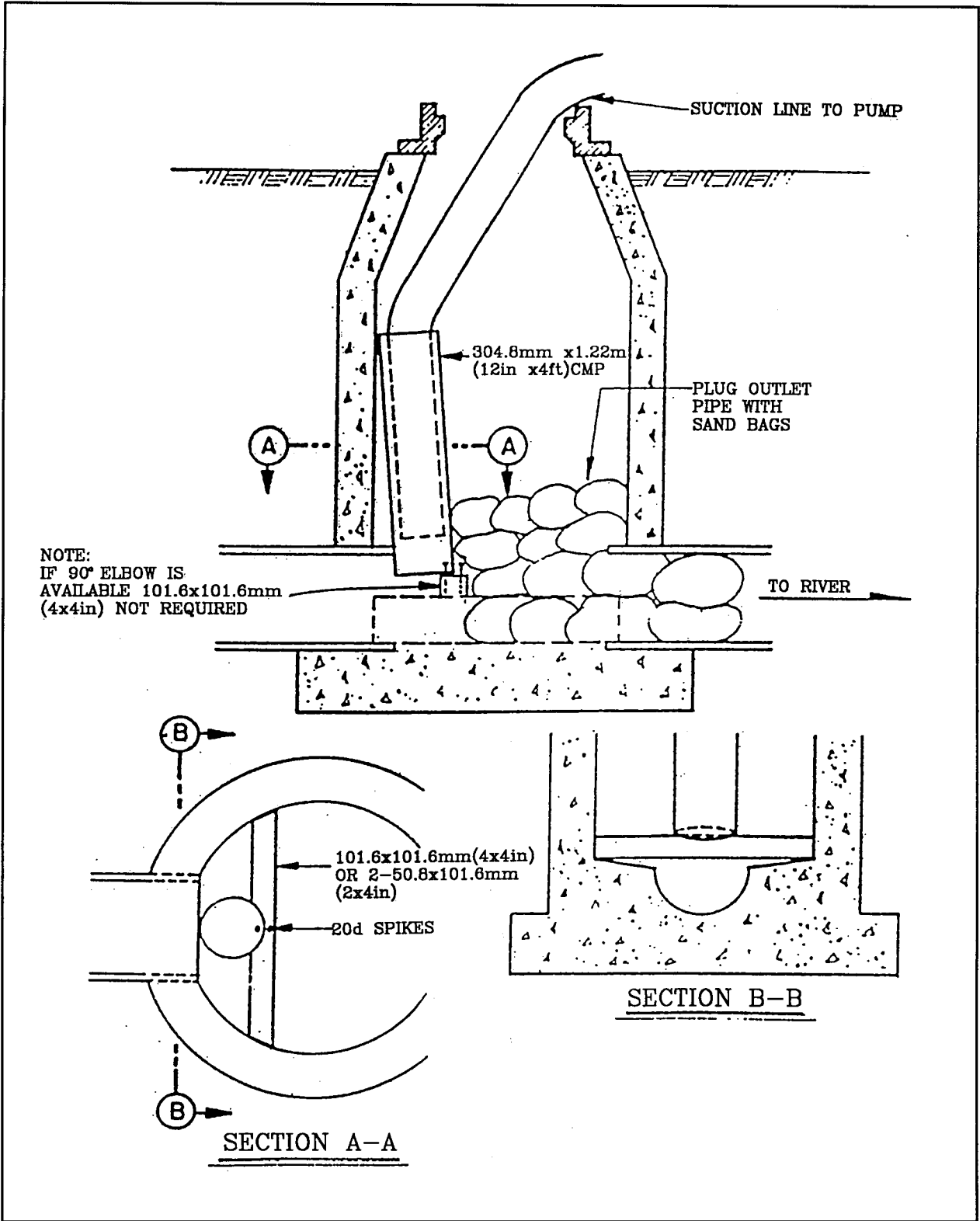

Figure F-11. Suction line to pump from manhole

of the landward slope. Evidence of this type of failure is found in undercutting and ravelling at the landside toe.

(c) Saturating flow. In this case, numerous small boils, many of which are scarcely noticeable, outcrop at or near the landside toe. While no boil may appear to be dangerous in itself, the consequence of the group of boils may cause flotation (“quickness”) of the soil, thereby reducing the shearing strength of the material at the toe, where maximum shearing stress occurs, to such an extent that failure of the slope through sliding may result.

(3) Combating sand boils. All sand boils should be watched closely, especially those within 30.5 m (100 ft) of the toe of the levee. All boils should be conspicuously marked with flagging so that patrols can locate them without difficulty and observe changes in their condition. A sand boil which discharges clear water in a steady flow is usually not dangerous to the safety of the levee. However, if the flow of water increases and the sand boil begins to discharge material, corrective action should be undertaken immediately. The accepted method of treating sand boils is to construct a ring of sandbags around the boil, building up a head of water within the ring sufficient to check the velocity of flow, thereby preventing further movement of sand and silt. See Figure F-12 for technique in ringing a boil. Actual conditions at each sand boil will determine the exact dimensions of the ring. The diameter and height of the ring depend on the size of the boil and the flow of water from it. In general, the following considerations should control: (1) the base width of the sandbag section should be no less than 1 1/2 times the contemplated height; (2) encompass weak soils near the boil within the ring of sandbags, thereby preventing a potential failure later; and (3) the ring should be of sufficient size to permit sacking operations to keep ahead of the flow of water. The height of the ring should only be that necessary to stop movement of soil, and not as high as to completely eliminate seepage. The practice of carrying the ring to the river elevation is not necessary and may be dangerous in high stages. If seepage flow is completely stopped, a new boil will likely develop beyond the ring; this boil could then suddenly erupt and cause considerable damage. Where many boils are found to exist in a given area, a ring levee of sandbags should be constructed around the entire area and, if necessary, water should be pumped into the area to provide sufficient weight to counterbalance the upward pressure.

e. Erosion. Erosion of the riverside slope is one of the most severe problems which will be encountered during a flood fight. Emergency operations to control erosion have been presented earlier under “Slope Protection.”

f. Storm and sanitary sewers.

(1) Problems. Existing sewers in the protected area may cause problems because of seepage into the lines, leakage through blocked outlets to the river, manhole pumps not spread throughout the sewer system, and old or abandoned sewer locations which were not found during preflood preparations. Any of these conditions can cause high pressures in parts of the sewer system and lead to the collapse of lines at weak points and blowing off of manhole covers.

(2) Solutions. During the flood fight, continued surveillance of possible sewer problems is necessary. If the water level in a manhole approaches the top, additional pumps in manholes may alleviate the problem. In sanitary sewers, additional pumping may be required at various locations in the system to provide continued service to the homes in the protected area. When pumps are not available, manholes may have to be ringed with sandbags or by some other method which allows the water to head up above the top of the manhole. To eliminate the problem of disposing of this leakage from manholes the ring dike would have to be raised above the river water surface elevation. This creates high pressures on the sewer and should not be done. As with sand boils, it is best to ring the manhole part way to reduce the head and dispose of what leakage occurs. Directly weighing down manhole covers with sandbags or other-items is not recommended

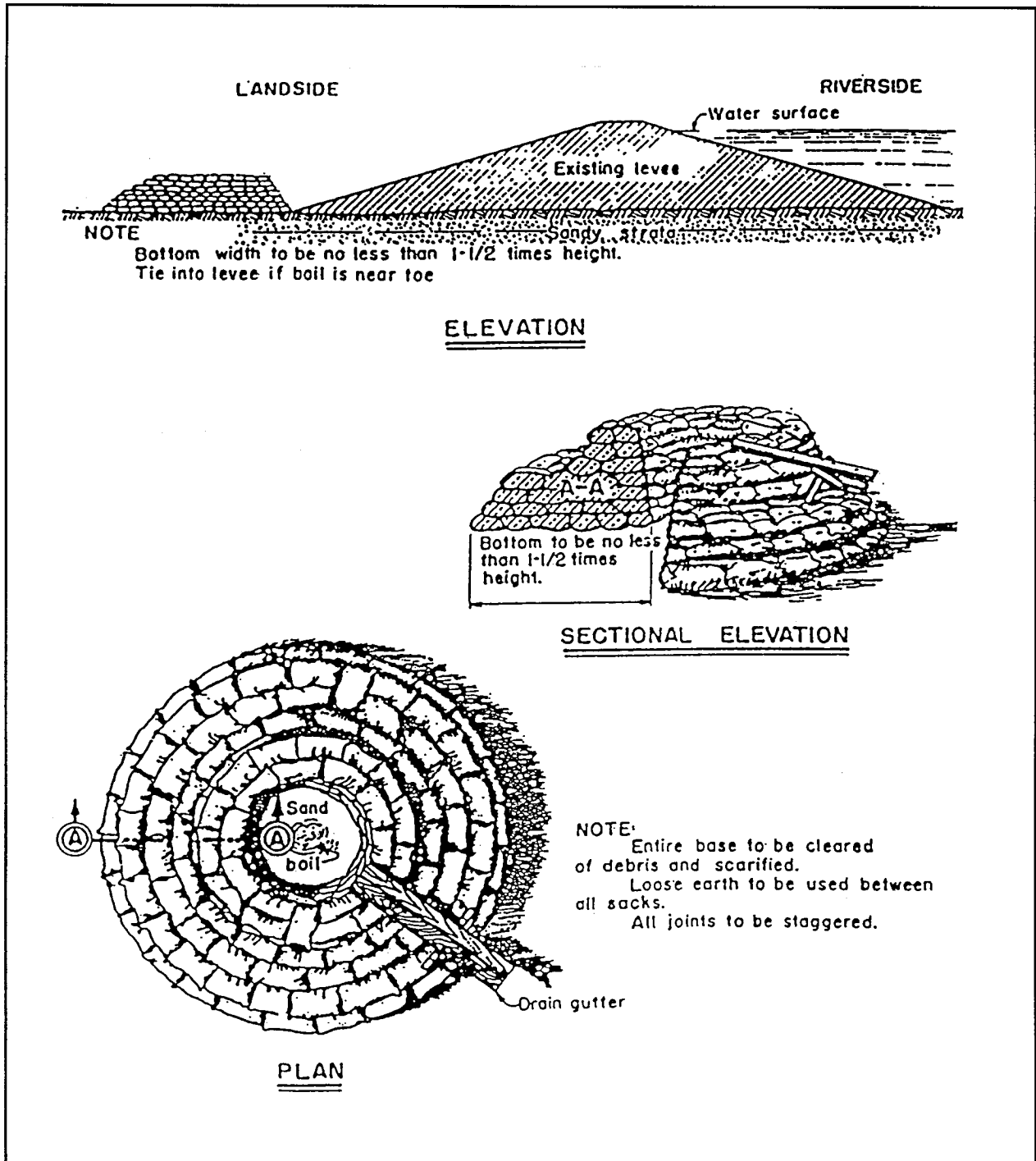

Figure F-12. Ringing sand boils

where high heads are possible. A 30-kPa (10-ft) head on a manhole cover 0.61 m (2 ft) in diameter would exert a force of 9.16 kN (2,060 lb-force). Thus, a counterweight of more than a ton would have to be placed directly on the cover.

g. Slope stability on weak foundations. In areas that have very weak foundation soils it may not be possible to construct full height flood barriers in preferred locations because of inadequate slope stability. However, if flood waters are slow to rise and fall, it is possible to use the rising floodwater as a restraining load on the riverside slope to meet stability criteria. This is usually used for closure structures or for staged construction where the flood barrier is only constructed after the river reaches an established level. This procedure would also require that the flood barrier be removed before the river went down below the established level.

h. Causes of levee failures. In addition to the problems covered above, the following conditions could contribute to failure:

(1) Joining of a levee to a solid wall, such as concrete or piling. Flood barriers consisting of sandbags greater than 0.91 m (3 ft) in height and joining a solid wall have performed poorly in the past due to excessive underseepage and instability of the sandbag prism.

(2) Structures projecting from the riverside of levee.

(3) A utility line crossing or a drain pipe through the fill.

(4) Tops of stoplogs on roads or railroad tracks at a lower elevation than the levee.

(5) Joining a sandbag barrier to a levee. Seepage problems at the juncture with the levee fill have caused very poor performance.

Appendix G Use of Soil Cement for Levee Protection

G-1. Purpose

The purpose of this appendix is to provide guidance on the design and construction of soil cement slope protection for levees and embankments. This includes soil cement, materials, mixture proportioning, design of slope protection, construction, quality control, inspection, and testing.

G-2. General Considerations

a. Soil Cement. The American Concrete Institute defines soil cement as a mixture of soil and measured amounts of portland cement and water compacted to a high density. Soil cement can be further defined as a material produced by blending, compacting, and curing a mixture of soil/aggregate, portland cement, possibly admixtures including pozzolans, and water to form a hardened material with specific engineering properties.

b. Application. Although riprap has historically been used for slope protection for levees, dams, channels, etc., there are situations when suitable rock is not available within economical haul distances and soil cement slope protection may be the most economical and appropriate selection.

c. History. The use of soil cement for slope protection has increased considerably over the past 30 years. The main focus of this effort has come from the U.S. Bureau of Reclamation (USBR) in the construction of dams. The first experimental use of soil-cement for slope protection was a test section constructed by USBR at Bonny reservoir in eastern Colorado in 1951. Observation of the performance of this test section for the first 10-year period of service indicated excellent performance of the soil cement which was subject to harsh wave action and repeated cycles of freezing and thawing. This led to the conclusion that use of soil cement for slope protection was feasible based on both economical and service life considerations.

d. Economics. The decision to use soil cement instead of riprap is primarily an economic one. However, not every soil is suitable for producing soil cement for this application. Therefore, the designer must compare the availability of suitable soil for soil cement versus the availability of suitable rock for riprap. The designer must prepare a cost analysis in arriving at a decision. Factors that must be considered for soil cement include cost of cement, location of suitable soil, special processing requirements if needed, haul distance, dimensions and configuration of the slope protection and mixing and placement methods. For riprap, considerations include cost and availability of rock, size and availability of rock, haul distance, special processing requirements, configuration of placement and placement effort. Cost estimates of the alternative methods provide the basis for the economic analysis.

G-3. Materials

a. Soils. In general most soils of medium to low plasticity (Plasticity Index (PI) equal to or less than 12) can be used for soil cement. However for levee protection, better quality granular materials are recommended since the soil cement may be subjected to repeated cycles of wetting-drying, freezing-thawing and wave action. It is recommended that the soil should not contain any material retained on a 2-in. (50.8 mm) sieve, nor more than 45 percent retained on a No. 4 (4.75-mm) sieve, nor more than 35 percent or less than 5 percent passing the No. 200 (0.075-mm) sieve. The PI should be equal to or less than 12 and

the organics content should be less than 2 percent. It should be noted that clay balls (nodules of clay and silt mixed with sand materials) can form when the PI is as low as 8. Clay balls can be detrimental when soil cement is exposed to weathering and the clay tends to wash out leaving voids in the soil cement structure. Clay balls greater than 25.4 mm (1-in.) should be removed and the minus 25.4-mm (1-in.) clay ball content should be limited to 10 percent. For economic reasons, the soil should be obtained from a borrow area close to the construction site. Samples from borrow sources must be evaluated for gradation and PI. If in-situ soils are not suitable it may be necessary to blend materials from several borrow sources.

b. Cement. Portland cements meeting specifications of ASTM C 150 are suitable. Generally, Type I is used for soil cement. However, soil cement can be subject to sulfate attack and it is the lime in the cement that is involved in the reaction. Therefore, sulfate bearing soils or water should be avoided. There is no definitive test to determine the threshold sulfate content at which a soil is deemed to be potentially reactive however experience has shown that soils with a sulfate content as low as low as 0.3 percent have developed reactions. If exposure to sulfates is not avoidable, Type II cement is recommended. Use of fly ash as a replacement for portland cement is not recommended in that experience has indicated that fly ash reduces early age compressive strength and durability when used in soil cement.

c. Water. Most water is acceptable for soil-cement. The primary requirement is that water should be free from substances deleterious to hardening of the soil cement. Specifically, water should be free from objectionable quantities of organic matter, alkali, salts, and other impurities. Presence of soluble sulfates should be of concern. Seawater has been used satisfactorily. The presence of chlorides in seawater may increase early strength. The quality of water for soil cement should be similar to that used for mixing concrete. Guidance on water quality may be found in Corps of Engineers CRD-C 400.

G-4. Proportioning Soil Cement Mixtures

a. General. One of the key factors that accounts for the successful use of soil cement is careful pre-determination of engineering control factors in the laboratory and their application during construction. The composition of soils varies considerably and these variations affect the manner in which the soils react when combined with portland cement and water. The way a given soil reacts with cement is determined by simple laboratory tests conducted on mixtures of cement, soil, and water. These tests determine three fundamental requirements for soil cement: the minimum cement content needed to harden the soil adequately; the proper moisture content; and the density to which the soil cement must be compacted. Generally, the procedure to determine the mixture cement content consists of the following steps: soil classification test to determine an appropriate soil type; moisture density tests at a selected initial cement content to determine target density and water content values; durability tests at a range of cement content values including the initial cement content; unconfined compressive strength tests; and selection of final cement content based on test results.

b. Selection of soils. The design of a soil cement mixture begins with selection of a suitable soil type. The objective is to select a soil that can be stabilized with the minimum cement content and that will be suitably durable for the range of service conditions to which it will be subjected. Guidance on specifications for grading and plasticity of soils were given previously. Generally, soil cement made with granular materials requires less cement than soil cement made with sands and fine grained soils. The latter materials are also less durable. If the soils available in the immediate area of construction do not meet desired specifications it may be necessary to blend several soil types to obtain the desired characteristics. However, before blending is specified, the increased costs of processing and monitoring should be compared to the increased cost of additional cement required for the natural material. Occasionally the designer may encounter soils that are unreactive or are marginally reactive requiring apparently excessive amounts of cement. Often such soils contain acidic organic materials that affect the reaction.

c. *Cement content general.* A series of laboratory tests must be conducted to determine cement content. Inherent in these tests is also the determination of design soil density and water content. If the project is large and more than one candidate soil is available, it may be appropriate to conduct the entire series of tests on each soil to determine the most economical mixture for the project. Also, if several borrow areas having significantly different soils are involved it may be necessary to conduct laboratory tests on soil from each borrow area to determine the appropriate mixture for each soil. The tests involved in this process include: moisture density tests (ASTM D 558) to determine initial design density and moisture content based on a selected initial cement content and durability tests (ASTM D 559 and D560) to determine resistance to repeated cycles of wetting and drying and freezing and thawing which might be expected under natural climatic changes. Compressive strength tests (ASTM D 1632 and D 1633) should be conducted on laboratory prepared specimens. Tests are conducted at several cement content values and the final cement content is that which produces the required durability and strength at the lowest practical cement content. Strength and rate of strength gain are important factors in performance of the soil cement. Adequate strength is required to resist forces of wave action and uplift pressures.

d. *Moisture density tests.* Moisture density tests are conducted to determine values of density and water content for molding soil cement durability samples and for field control of compaction during construction. The cement content for moisture density tests is selected based on soil classification. Soils should be classified following procedures indicated in ASTM D 2487, Standard Test Method of Classification of Soils for Engineering Purposes. Initial cement contents for different soil classifications are indicated in Table G-1. The appropriate value of cement content for moisture-density tests may be selected from this table. Only coarse grained soil symbols are shown as these are the soil types preferred for soil cement for slope protection. Representative soil samples should be collected and moisture density tests conducted following procedures indicated in ASTM D 558, Standard Test Methods for Moisture Density Relations of Soil Cement Mixtures. Results of the tests are plotted as shown in Figure G-1 from which values of dry density and moisture content are selected for molding durability specimens. The dry density may be the maximum or a percentage of the maximum density indicated on the plot. Past experience has indicated that a minimum density of 98 percent of the maximum ASTM D 558 density is adequate. The water content is the value associated with the selected density. The water content at maximum dry density is termed the "Optimum Water Content" (OWC).

Table G-1
Initial Cement Content for Moisture Density Tests

Soil Classification (ASTM D 2487)	Initial Cement Content (percent dry weight of soil)
GW, GP SW, SP	7
GM, SM	8
GC, SC	9
SP	11

e. *Durability tests.* Two types of durability tests are conducted: ASTM D 559, Standard Test Methods for Wetting and Drying of Compacted Soil Cement Mixtures and ASTM D 560, Standard Test Methods of Freezing and Thawing of Compacted Soil Cement Mixtures. These tests were designed to reproduce in the laboratory the moisture and temperature changes expected under field conditions. These tests measure the effect of internal volume changes produced by changes in moisture and temperature. From these tests the minimum cement content required to produce a structural material that will resist volume changes produced by changes in moisture and temperature can be determined. Wet dry tests should be conducted in all geographic areas. Freeze-thaw tests should be conducted in all areas that experience at least one cycle of freezing and thawing per year since levee protection is expected to be subjected to this condition over a long

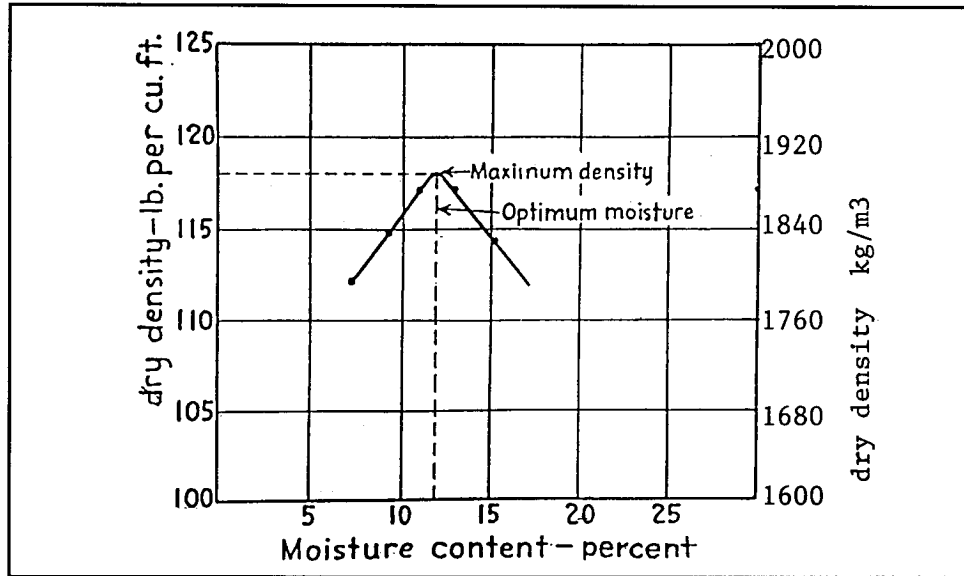

Figure G-1. Typical moisture-density curve

period of time. If there is absolutely no expectancy of freeze thaw cycles in the geographic area this test may be omitted. Each type of test consists of twelve two-day cycles of wetting/drying or freezing/thawing as appropriate and thus requires 24 days to complete.

For each type of test, duplicate specimens of soil cement should be prepared at cement contents equal to the cement content used for the moisture density test and at cement contents 2 percent above and 2 percent below that used for the moisture density test. For example, if the cement content for moisture density tests is 7 percent, samples for durability tests should be molded at 5, 7, and 9 percent cement. Ideally, a moisture-density test should be conducted for each cement content to determine maximum density and optimum moisture water content for that particular design mixture since these values vary with cement content. If this is not possible the density and moisture content determined from the initial tests may be used.

After each cycle (of either the wet-dry or freeze-thaw) the specimen is scrubbed with a wire brush to remove soil cement that becomes loosened or unbonded as a result of exposure to the test environment. After the twelve cycles are completed, the total weight loss is calculated and this value is compared to established criteria. The weight loss criteria are shown in Table G-2. Assuming both tests are conducted, specimens must meet both criteria. If specimens do not meet both criteria, adjustments must be made in the soil gradation and/or cement content based on engineering judgment and at least one set of tests should be rerun. Adjustments may include blending of aggregate to the soil and/or increasing the cement content.

Table G-2
Durability Test Weight Loss Criteria

Type of Durability Test	Maximum Weight Loss After 12 Cycles (percent)
Wet Dry (ASTM D 558)	6
Freeze Thaw (ASTM D 559)	8

f. *Unconfined compressive strength tests.* The next step is to conduct unconfined compressive strength tests (ASTM D 1632 Making and Curing Soil Cement Compression and Flexure Test Specimens in the Laboratory, and ASTM D 1633 Compressive Strength of Molded Soil Cement Cylinders). Strength of the soil cement is important in slope protection to provide resistance to wave action and uplift pressures. In fact, strength may be the determining factor in arriving at the final design cement content. Experience has shown that often the cement content of specimens meeting compressive strength criteria is higher than that necessary to meet durability requirements. The cement content for specimens for initial compressive strength tests will be the minimum cement content of the specimens that met durability criteria. The water content and dry density will be that used to mold durability specimens. Duplicate specimens should be prepared and tested as indicated according to the ASTM procedures previously indicated. Minimum compressive strength criteria are indicated in Table G-3. If strengths of specimens tested at the initial cement content do not meet minimum criteria, then the cement content should be increased in two percentage point increments and compressive strength tests rerun until criteria are met or it is determined that another mix design approach must be undertaken. If time constraints do not permit conduct of unconfined compressive strength tests until the durability tests have been completed, it may be necessary to conduct these tests simultaneously. If this is necessary, the unconfined compressive strength tests should be conducted on specimens prepared at all of the cement contents used in the durability tests. This approach obviously requires that many more specimens be prepared and tested however the savings in time may be more economical than conducting the tests in sequence.

Table G-3
Unconfined Compressive Strength Criteria (ASTM D 1633)

Cure Time (days)	Minimum Compressive Strength, kPa (psi)
7	4138 (600)
28	6034 (875)

g. *Final cement content.* The final cement content is the minimum cement content used in specimens that met or exceeded both the durability and compressive strength criteria. Some designers have added one or two percentage points to this cement content to account for variability in the field cement content where the proposed method of construction is mixed in place. Where central plant mix procedures are used control of cement content is generally accurate.

G-5. Design of Slope Protection

a. *General considerations.* Design of slope protection with soil cement is somewhat similar to design with riprap in that protection must be provided against erosional forces from wave action and stream currents. Soil cement slope protection can be provided in two configurations: stair step or plating. In stair step slope protection the soil cement is usually placed in successive horizontal layers adjacent to the slope. This method is preferred for slopes exposed to moderate to severe wave action or debris carrying, rapidly flowing water. The plating method consists of placing one or more layers of soil cement parallel to, i.e., directly on, the slope. This method is used where less severe exposure is expected.

b. *Stair step method.* The stair step method consists of constructing successive horizontal lifts of compacted soil cement up the slope to the desired height of protection (Figure G-2). Each successive lift is set back by an amount equal to the compacted lift thickness times the cotangent of the slope which results in a stair step pattern approximately parallel to the embankment slope. Layer thickness can be from 152.4 to 304.8 mm (6 to 12 in.) depending on the type of compaction equipment used. Historically, stair step construction has been accomplished with 152.4 mm (6 in.) compacted lifts. However, thicker lifts require less

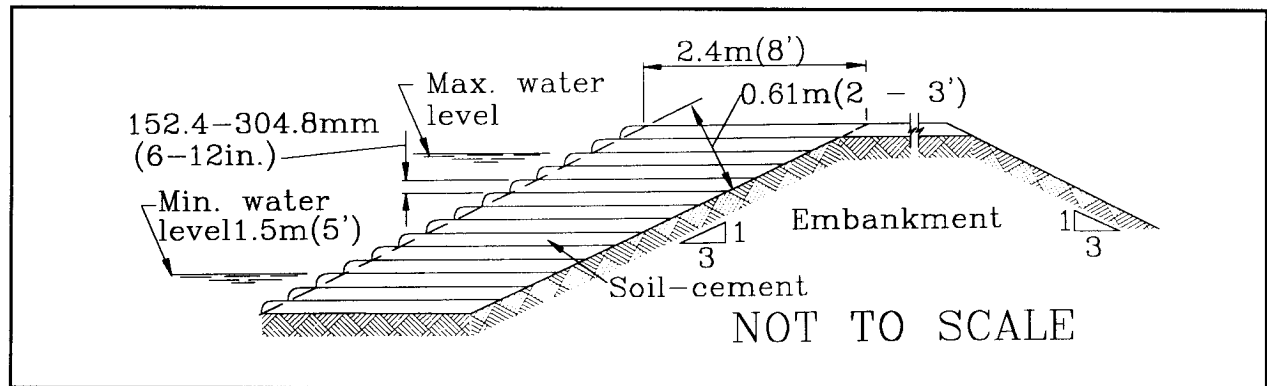

Figure G-2. Stair-step method of slope protection

construction effort and result in fewer bond surfaces. The disadvantage of thicker lifts is more loss of soil cement at the exposed edge during construction and additional effort is required to obtain desired density throughout the lift. The width of the layer also is a function of type and size of construction equipment. Experience has shown that a layer width of about 2.4 m (8 ft) is generally most convenient. Since stair step protection is indicated for more severe environmental conditions, a thicker covering over the slope is generally specified. Experience has indicated that the total thickness of soil cement measured perpendicular to the slope should be 0.61 to 0.92 m (2 to 3 ft). The relationships between slope, facing thickness, layer thickness and horizontal layer width are shown in Figure G-3.

c. Plating method. The plating method consists of lifts placed parallel to, i.e., directly on, the slope and is used in areas where a thinner facing is required. Generally two 152.4 mm (6-in.) lifts or one 203.2-mm (8-in.) lift are used for plating. One of the primary considerations in plating protection is providing resistance to high flow especially with debris. To date there are no definitive design criteria to determine lift thickness based on abrasion, however, since the plating method is applicable for areas subjected to less harsh environments, experience has shown 304.8 mm (12 in.) of protection is adequate. In the plating method, lifts can be constructed so that the resulting construction joints are either parallel or perpendicular to the flow of water. If placement and compaction of the soil cement are up and down the slope, the construction joint will be perpendicular to the water flow. If placement and compaction are along the slope, the construction joints will be parallel to the flow of water. For the plating method of construction, the slope should be 3H:IV or flatter in order to properly spread and compact the soil cement. Construction on steeper slopes may be accomplished if special compaction equipment is used.

d. Freeboard and wave runup. Freeboard is the vertical distance from the top of the levee to the water surface. The freeboard should be sufficient to prevent waves from overtopping the levee or damaging the crest. Slope protection should be provided in the freeboard area to prevent erosion. When a wave contacts the face of the levee it will run up the slope. Wave run up is the vertical height above the still-water level to which the uprush from a wave will rise on a structure. It is not the distance measured along the inclined surface. To calculate the wave run up for soil cement slope protection, the wave run up value based on riprap protection is first calculated and this value is multiplied by a factor based on the type and condition of the soil cement slope protection. For calculation of wave run up for riprap, designers should consult the following references: EM 1110-2-1614, Design of Coastal Revetments, Seawall, and Bulkheads, dated 30 June 1995; and the Automated Coastal Engineering System (ACES) computer program. For stair step construction with vertical faces on the layers the run up factor is 1.2. Where the faces have become rounded due to weathering and erosion the run up factor is 1.3. For plating slope protection the run up factor is 1.4.

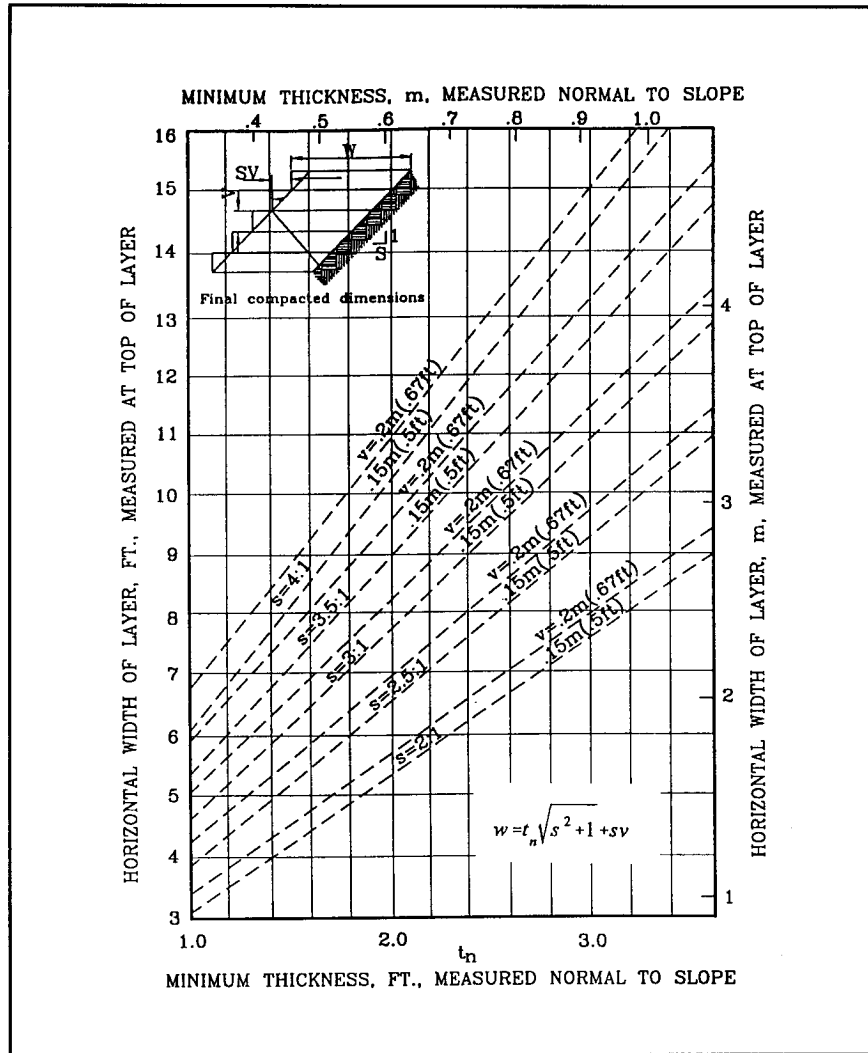

Figure G-3. Relationship of slope, facing thickness, layer thickness, and horizontal layer width

e. *Transitions.* Transitions between soil cement and earth or other structures should be addressed. Tie-backs similar to riprap placements can be designed to avoid flanking of the structure. An alternative is to use a riprap section at either end of the soil cement structure. Where soil cement joins other structures and compaction is difficult it may be appropriate to use lean concrete.

f. *Drainage and seepage.* Although no distress to soil cement slope protection due to rapid drawdown has been reported and the current thinking is that drainage is not required unless severe drawn down is anticipated, the designer should be aware of the preventative measures can be used. Three concepts are presented. One is design of the levee so that the least permeable zone is adjacent to the soil cement. This will provide protection against build up of excess pore water pressure. A second method is to determine that the weight of the facing is sufficient to resist uplift pressures. Here, there may be some pore pressure relief through shrinkage cracks in the soil cement. Obviously, some estimate must be made of the gross hydraulic conductivity of the soil cement. A third measure is to provide deliberate drainage conduits through the soil cement. This approach was used by the Bureau of Reclamation at Merrit Dam. Three rows of 76.2- to

127-mm- (3- to 5-in.-) diameter weep holes were drilled into the facing after construction and included 118 holes on 3.05 m (10 ft) centers. In such arrangements, a filter is placed in the area of weep hole before soil cement construction.

G-6. Construction

a. General. There are two general methods in common use for constructing soil-cement: mixed-in-place and central mix plant. Regardless of the equipment and methods used the goal is to obtain thoroughly mixed and adequately compacted and cured soil-cement. The central mix method involves mixing of a borrow material with cement and water, at a centrally located plant. The mixture is then transported to the site. The mixed-in-place method involves mixing of cement and water with the in-place soil at the site, and is infrequently used for embankment soil cement applications.

The most common method of soil-cement construction for bank protection is central mix plant. For soil-cement used as bank protection, particularly where banks experience higher flow velocity forces, adequate strength and durability, and consistent quality, are primary requirements. It is harder to achieve these objectives using mixed-in-place construction than central mix plant.

Two methods are used for placement and compaction of soil cement for embankments: stair step or plating. Design for these methods was discussed earlier in this document. The stair step method is the predominant method used, although construction using both methods is discussed in the subsequent sections on spreading and compaction.

Soil cement should not be mixed or placed when the soil or subgrade is frozen or when the air temperature is below 9°C (45°F). Specifications may allow soil cement construction to proceed if the air temperature is at least 4°C (40°F) and rising. Hot weather poses a few problems for soil cement construction, requiring sometimes additional moisture application to the materials, faster placement and compaction operations, and additional curing effort.

b. Central mix plant construction. There are two basic types of central mix plants: pugmill mixers either continuous or batch type, and rotary drum mixers (also a batch type of mixer). The uniformity of soil cement produced by these plant types is generally roughly equivalent, provided they have been properly calibrated. Continuous mix pugmill plants have higher production rates, while batch plants are often easier to calibrate, and require less frequent calibration. Batch-type pugmill plants have been used, but infrequently. Production rates between 76.4 and 152.9 m³ (100 and 200 cu yd/hr) are common for stair-step soil cement construction. The basic steps of central mix plant construction of soil cement are: subgrade preparation, borrow materials, mixing, transporting, spreading, compacting, bonding lifts, finishing, construction joints, and curing and protection.

(1) *Subgrade preparation.* A firm subgrade is necessary to compact the overlying layers of soil cement to the required density. The subgrade is prepared by removing and replacing, or stabilizing, soft or wet areas, removing deleterious materials, and grading and compaction to construction plans and specifications. Most overly wet subgrade areas can be corrected by aerating and recompacting, or some type of chemical stabilization. Dry subgrades are surface moistened immediately prior to soil-cement placement.

(2) *Borrow materials.* Soil borrow sources are usually near the construction site and may consist partially or wholly of excavated bed and/or bank material. Native borrow materials are naturally variable in composition. Excavation, blending and stockpiling methods for borrow material should be selected to minimize this variation, and produce as consistent a material as possible. Horizontally stratified soil layers can be blended by deep excavation using full face cuts, insuring all layers are cut with each equipment pass.

If materials vary laterally across the borrow areas, loads from different locations should be blended in a systematic fashion. Further blending can also be done as materials are brought to the plant stockpile area. Alternating the loads from different parts of the plant stockpiles, or even using a front-end loader to take a vertical cut of the stockpiles, also helps blend materials as they are fed to the mixing plant.

Screening the borrow material through a 25-mm (1-in.) to 38.1-mm (1-1/2-in.) mesh at the pit or at the plant can help remove oversize clay balls and other oversize materials. Selective excavation may be necessary to avoid excessive clay balls or clay content in the borrow area.

Stockpiles should be separated from each other and all plant equipment by at least 15.2 m (50 ft). Where the soil contains coarse aggregate, stockpiling is done in layers to minimize segregation.

(3) *Mixing*. Central mixing plants with rated capacities of 227 to 907 metric tons (250 to 1,000 tons) per hour (about 95.56 to 382.3 m³ (125 to 500 cu yd)) are used commonly. Special blending requirements may require several stockpiles and separate storage feeder bins. Prior to mixing and placing, it is necessary to measure the quantities and proportions of material supplied by the plant. The plant should be accurately calibrated.

(a) *Pugmill mixers*. The most common continuous mixing plants contain a twin shaft pugmill. Figure G-4 shows a diagram of a typical pugmill central mix plant. USBR recommends a twin-shaft pugmill with a rated capacity of at least 152.9 m³ (200 cu yd)/hr. A pugmill mixing chamber contains twin shafts rotating in opposite directions, with paddles (see Figure G-5) that force mix the soil cement and move it through the chamber by the pitch of the paddles. Material feeds (by adjusting gate openings and belt speed) and pugmill features (such as pugmill tilt and paddle pitch) may be adjusted to optimize the mixing actions and production. Thoroughness of blending is partly determined by the length of mixing time. A mixing time of 30 sec is commonly specified, although shorter times have also been shown to be adequate, depending on the mixer efficiency.

Batch type pugmill mixers, where the materials are delivered to a pugmill mixer in a discrete batch rather than as a continuous ribbon of material, can provide effective mixing of soil cement, but are seldom used, largely due to lower production capacity and lack of availability.

(b) *Rotary drum mixers*. Although rotary drum (also called tilt drum) mixers are sometimes used, they are generally lower in production capacity than pugmill mixers. These plants are typically converted central mix concrete plants, and function in the same manner. Mixing times for these plants are typically about 60 sec.

(4) *Transporting*. Haul trucks can be of the end or bottom dump variety, although many types are used. Where conditions are extremely hot and/or windy or where sudden showers are a possibility, soil cement should be protected by using canvas covers on haul vehicles. Equipment should be clean. The elapsed time between mixing and compacting should be kept to a minimum. Sixty minutes is usually the maximum. Therefore, most specifications require haul times to be kept below a maximum of thirty minutes.

In stair step construction, temporary ramps are constructed at intervals along the bank to enable trucks to reach the layer to be placed. These temporary ramps should have a minimum 0.457 m (18-in.) thickness of material to protect the edge of the previous lift from truck traffic. There is also a requirement, where streambeds are dry, for ramps to be spaced to allow egress from the channel in case of a flood. These are constructed at 45° angles, with a minimum of 0.61 m (2 ft) of cover over the soil cement, and spaced about 91.4 to 121.9 m (300 to 400 ft) apart.

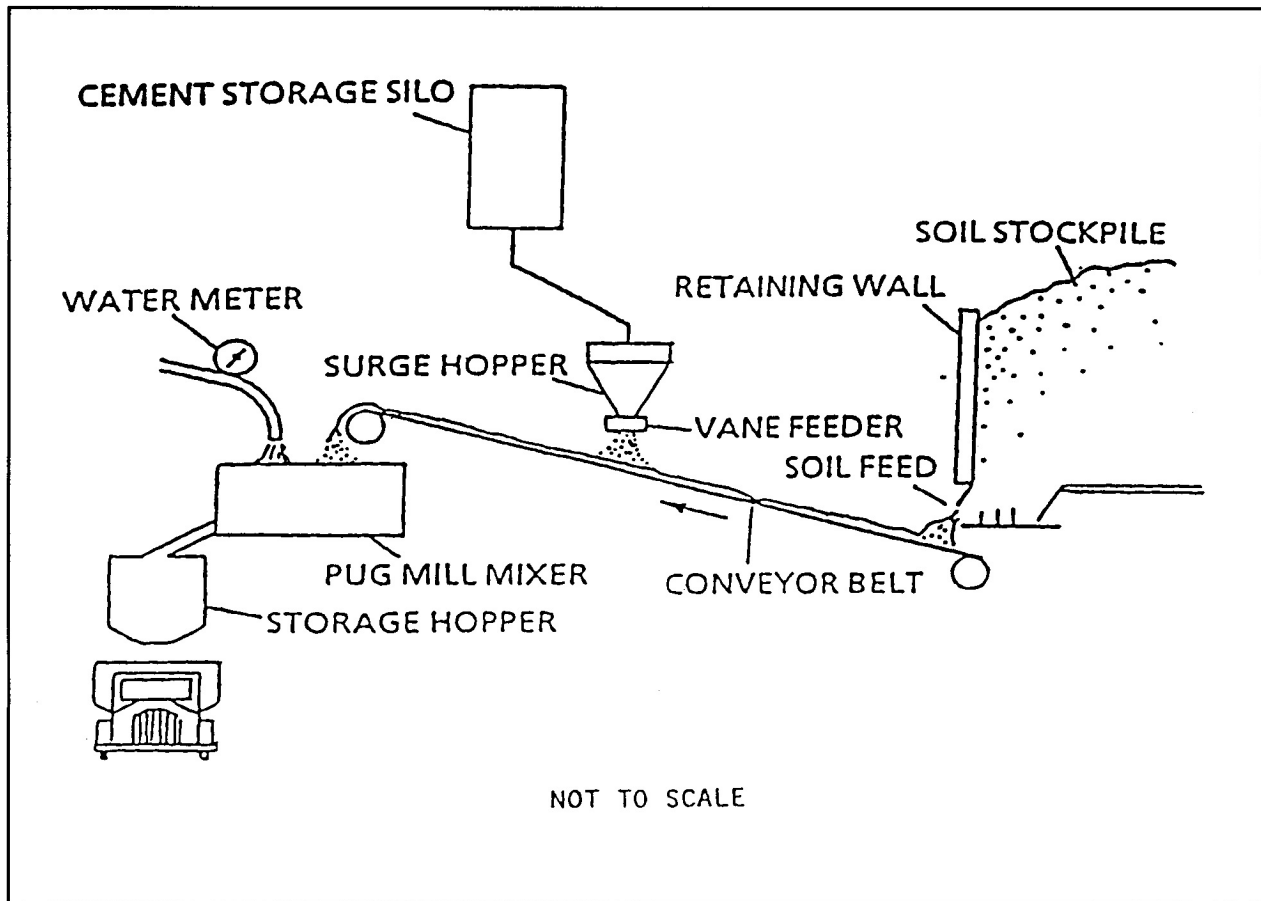

Figure G-4. Typical pug mill central plant



Figure G-5. Mixing paddles of a twin-shaft, continuous-flow central mixing plant

Figure G-6 shows a typical step-construction sequence. Frequently time and cost savings have been realized by using conveyor systems to deliver the soil cement to the spreader. This removes the necessity for ramp construction and truck maneuvering and provides a cleaner end product. Narrower layers and plating applications can also be placed using a conveyor system. The soil cement can be delivered from above or below directly to a spreader box.

(5) *Spreading.* Soil cement must be spread in a manner that will provide a compacted layer of uniform thickness and density, conforming to the design grade and cross section.

(a) *Stair step method.* There are a wide variety of spreading devices and methods for stair step construction. One of the most common is the spreader box attached to a dozer or grader. An

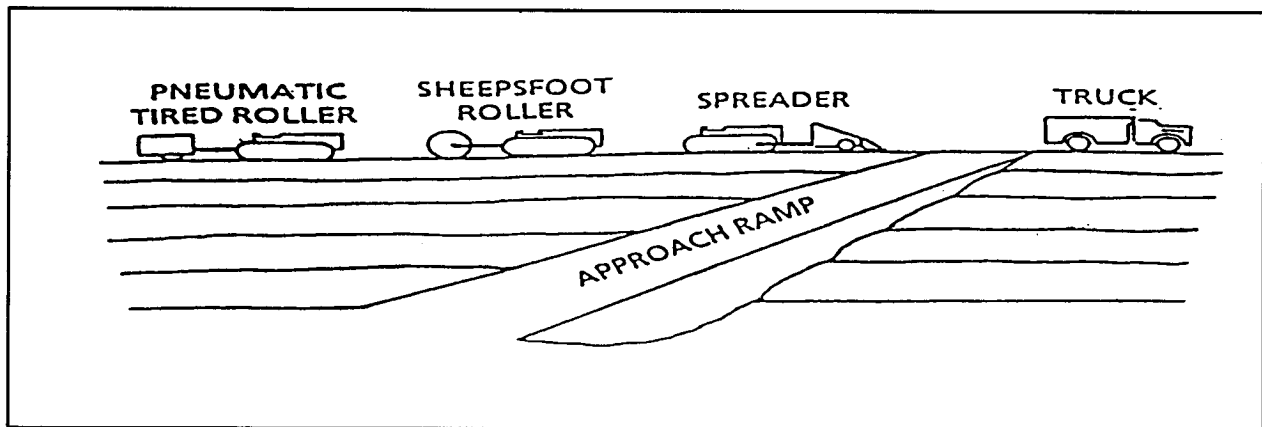

Figure G-6. Typical construction sequence

alternate method is to place material in windrows to be spread by a grader. Care must be taken with the windrow operation not to over manipulate the material which may cause separation and premature drying. Layers are spread 15 to 30 percent greater than the required compacted thickness. Experimentation may be necessary to determine the appropriate spread thickness since different combinations of equipment and soil type may produce different amounts of precompaction. Spreading may also be done with asphalt-type or RCC pavers. Some of these pavers are equipped with one or more tamping bars which provide some initial compaction.

Placement of stair-step sections may need to be limited to a maximum of 1.22 m (4 ft) height in a single shift to avoid instability producing bulging in the outer face from the surcharge weight of material and equipment above.

(b) *Plating method.* A variety of methods may be used for spreading of soil cement for plating applications. On relatively level surfaces, the methods are the same as for stair step placement. Plating construction on steeper slopes requires different procedures than stair step construction. Dozers are commonly used to spread soil cement on steeper slopes. USBR has reported best results in terms of producing uniform thickness and minimum waste when soil cement was spread from the top to the bottom, rather than from bottom to top. Whatever method is used, careful attention needs to be paid to achieving uniform thickness.

(6) *Compaction.* Minimum compaction to be achieved in the field is normally specified as a percentage of maximum density determined by ASTM D 558 or ASTM D 1557, typically requiring 98 percent of maximum density. Moisture content of the soil cement mixture must be controlled within tight limits to ensure consistent optimum conditions for compaction. USBR practice has been to place soil cement at water contents at or slightly dry of optimum. This can help avoid excessively wet mixes that may cause traffic and compaction difficulties, as well as lift distortion and increased cracking due to shrinkage. Compaction should begin as soon as possible and be completed within about one hour after initial mixing. No section of soil cement should be left unworked for longer than 30 min. Climatic conditions at some sites, such as very cool, humid weather, may allow relaxation of this guidance. Moisture loss by evaporation during hot weather compaction should be replaced by light applications of water. Compaction is done by various types of rollers. For fine grained soils, a sheepsfoot roller is generally used for initial compaction, followed by a pneumatic-tire roller for final compaction. USBR practice has often been to compact the lower portion of the lift with a towed sheepsfoot roller, using the vibratory steel-wheeled roller for the upper portion of the lift. Some problems have been encountered with vibratory roller compactors when used for finer grained materials. Vibratory rollers may create fine transverse cracks in the soil cement surface, requiring a

rubber-tired roller for final compaction to close most of the cracks. Compacting soil cement at or above optimum moisture can produce rutting from pneumatic tire rolling. For coarse grained soils, vibratory steel-wheeled or heavy pneumatic rollers are generally used. Compacted layer thickness is typically from 152.4 to 228.6 mm (6 in. to 9 in.), although greater thicknesses of coarse grained soils can be compacted with heavy equipment designed for thicker lifts. The specified minimum density must be achieved throughout the lift thickness, regardless of the lift thickness and compaction equipment used. Compactor weight, and vibration amplitude and frequency must be adjusted during construction to obtain the best compaction. Test sections are a valuable aid in determining the optimum compaction equipment characteristics and procedures.

(a) *Stair step method.* Compaction of the outer edge of the layer is usually not necessary from the standpoint of structural integrity. However, uniform edges provide a better appearance and allow for easier emergency egress from streambeds. Sharp edges reduce wave runoff but increase roughness. Edge compaction can be accomplished by hand tampers or through the use of some type of edge support during compaction.

(b) *Plating method.* Compaction is done with various roller types. Construction on near horizontal surfaces is similar to layered construction. Compaction on steeper side-slopes requires different procedures. A rolling deadman (Figure G-7) has been used to winch the roller up and down slope. Adequate compaction has been achieved using bulldozers, although their use is not recommended. Multiple overlapping passes are usually required. Surface tearing can be minimized by using cut grousers or street pads. Compaction from bottom to top has been most successful.

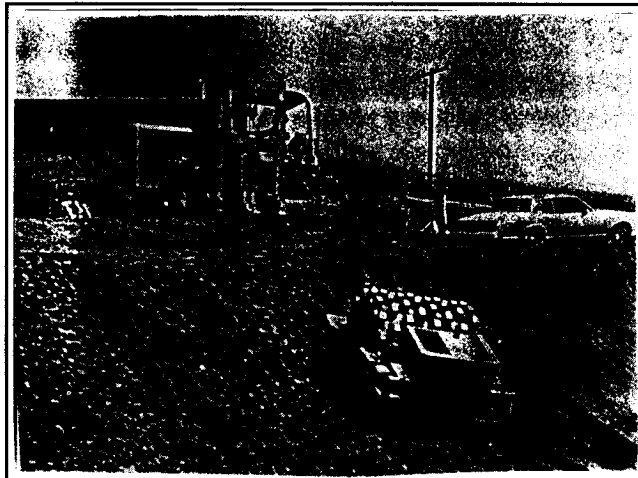

Figure G-7. "Deadman" pulling vibratory sheepfoot roller up the slope

(7) *Bonding lifts.* The bond between soil cement layers is generally weak. No definite criteria is available on the most effective methods of bonding between layers; however, bonding may be considered if layer separation is anticipated. Layer separation may be a concern from strong wave action, or at the upper lift of some sections, where there is little weight above the lift to mobilize shear resistance. The most significant factor in bond strength is time delay between lifts. The shorter the time between lifts the better the bond. Long placements may be broken up into shorter segments, enabling subsequent lifts to be placed more rapidly. Moist curing increases the bond strength but excess water tends to decrease it. Most specifications require temporarily exposed surfaces to be kept moist and clean. Care must be taken to avoid tracking clay or other materials onto

the layer which would reduce bond.

Power brooms should be used for lift surface cleaning to remove loose and unbonded material. USBR studies have suggested that roughening the lift surface with steel power brooming does not significantly contribute to increased bond strength. Brooming is not permitted prior to 1 hr after compaction to allow adequate set of the soil cement.

Both dry cement and cement slurry lift bonding have been used and evaluated in USBR test sections, with encouraging results. A slurry mix should have a water/cement ratio of about 0.70 to 0.80 and an application

the latter rate. Dry cement applications have a disadvantage of being susceptible to wind, while cement slurry is susceptible to rapid drying. Whichever method may be used, the material should be applied immediately before placement of the next lift.

(8) *Finishing.* As compaction nears completion the entire layer should be shaped to specified lines, grades, and cross sections. Edge shaping can be done with a modified blade or a curved attachment on the roller. The lift may require scarification to take out imprints left by equipment or to remove thin surface compaction planes. Scarification can be done with a variety of spring tooth or spike toothed harrows, or similar equipment. Soils containing gravel may not require scarification. Final surface compaction following scarification is performed with a steel-wheeled roller in nonvibratory mode, or a rubber-tired roller. A smooth “table top” finish is not required and may be detrimental to lift joint shear strength. Wheel marks are acceptable, although they may make lift joint cleanup more difficult

The edges on stair-stepped soil cement applications have been finished by cutting back the uncompacted edges, by using special rounded attachments on compaction equipment, and by leaving sacrificial uncompacted edge material in place to be eroded later.

(9) *Construction joints.* Construction joints are required at the completion of each day’s work or when work must be stopped for time periods longer than allowed for placement and compaction of fresh soil cement. They are made by cutting back into the finished work to proper crown and grade. The joint must be vertical, full depth, and transverse to the layer direction and is usually done with the toe of a grader blade or bulldozer blade. Care must be taken that no debris is present on the joint edge, and that new material placed against the joint adheres to the previous work. Joints should be staggered to inhibit cracking throughout the structure

(10) *Curing and protection.* Proper curing is essential, because strength gain and durability is dependent upon time, temperature and the presence of moisture. All permanently exposed surfaces should be moist cured for a period of seven days. Traffic should be kept off the soil cement during the curing period. Light traffic is sometimes allowed on the completed soil cement, provided the curing is not disrupted.

Soil cement must be protected from freezing during the curing period. Insulation blankets, straw, or a soil cover are commonly used. Light rainfall should not interrupt construction. However, a heavy rain prior to compaction can be detrimental. For mixed-in-place operations, if rain falls during the cement spreading operation, the cement already spread must be quickly mixed with the soil, and compaction must proceed immediately. After soil cement has been compacted, rain will seldom have detrimental effects.

(a) *Moist curing.* Water curing may be done with fog spraying, or with weighted and secured plastic sheeting if wind is not a problem. Wet burlap can also be used if a moist condition can be maintained. A minimum of 152.4 mm (6 in.) of moist earth can be specified as an alternative. The earth cover may also inhibit freezing should colder temperatures be expected.

(b) *Bituminous membrane curing.* Membrane curing using some types of bituminous material (generally an emulsified asphalt) can be used as an option to water curing where no succeeding layers will come in contact with the membrane. However, the black color may be objectionable to owners. Bituminous membrane curing should not be used for levees, ponds or reservoirs which will have water frequently in contact with the membrane, without evaluation of environmental effects of the bituminous membrane. An application rate of 0.68 to 1.4 ℓ/m^2 (0.15 to 0.30 gal/sq yd) is required. The soil cement should be moistened just prior to the membrane application. Sand can be spread over the bituminous membrane curing if light traffic is necessary, to prevent tracking of the bituminous material.

c. *Mixed-in-place construction.* In-place mixing is generally not used nor recommended for multi-layer construction. Plating type embankment applications are possible with the mixed-in-place method of soil cement, although again are not recommended. The basic steps in mixed-in-place construction are: soil preparation, cement addition, pulverization and mixing, compaction, finishing, curing, and protection. Following mixing, the construction techniques are essentially identical to central plant soil cement and are not further discussed under the mixed-in-place method. Although windrow type mobile pugmill mixers are used for pavement mixed-in-place construction, they are seldom used for embankment applications. Mix-in-place operations are generally performed using transverse single or multiple-shaft rotary mixers (see Figure G-8). In-place strength of the soil cement using mixed-in-place construction may be only 60 to 80 percent of the laboratory values, due partly to less efficient mixing compared to central mixing. Adding one to two percent cement is common practice to compensate for the higher variation in strength using mixed-in-place construction.

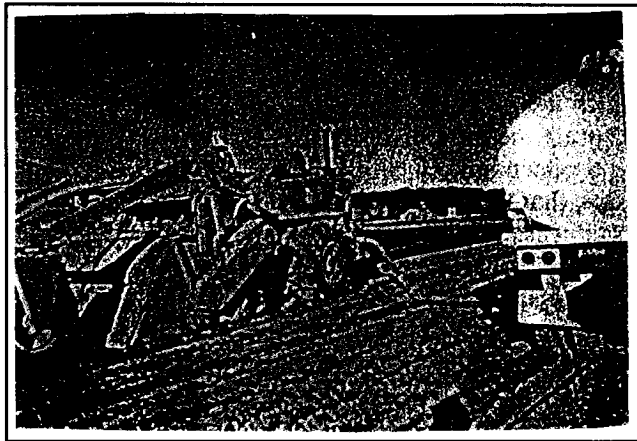

Figure G-8. Transverse single-shaft rotary mixer

(1) *Soil preparation and pulverization.* The soil is prepared by removing and replacing, or stabilizing, soft or wet areas, removing deleterious materials such as stumps, large roots, organic soils, and aggregate greater than 76.2 mm (3 in.) in size, and grading to the approximate final design profile. Most overly wet areas can be corrected by aerating and recompacting, or some type of chemical stabilization. Proper moisture content is essential for unimpeded construction traffic and for satisfactory pulverization and mixing. Dry soils may be disced and wetted by spray trucks until moisture content is near optimum for the soil cement. A moisture content near optimum may be necessary for pulverizing fine grained soils. Pulverization of soil prior to cementitious materials

spreading is generally necessary to insure uniform cement mixing. Pulverization of soils with higher fines content or higher plasticity may be difficult without proper moisture control and proper equipment.

(2) *Cementitious materials application.* Cementitious materials are distributed on the soil surface using a bulk mechanical spreader (see Figure G-9), or for smaller projects, by hand placing cement bags. Mechanical spreaders must be operated at uniform speed with a relatively constant level of cement in the hopper to produce a uniform spread of cement. Mechanical spreaders also require sufficient traction for proper distribution, sometimes requiring wetting and rolling the soil prior to spreading. Some spreaders are directly attached behind a bulk cement truck, where cement is pneumatically moved into the spreader hopper for distribution. PCA (1995) has convenient tables to convert the required cement content as a percentage by weight of oven-dry soil into a cement spread quantity in terms of weight of cement per square foot of soil surface. Cement spreading can be performed only when wind is absent and may require environmental permits. Although cement slurry spray applicators, including admixture capability, are available, they have not been widely used as yet.

(3) *Pulverization and mixing.* Most soils must be pulverized prior to mixing operations, using the rotary mixers. For mixing, single-shaft mixers require at least two passes; one to mix the soil and cement, and the second to add water. Multiple-shaft mixers handle these functions in one pass. Agricultural equipment does not generally give adequate results. In-place mixing efficiency is generally poorer than central mixed soil cement.

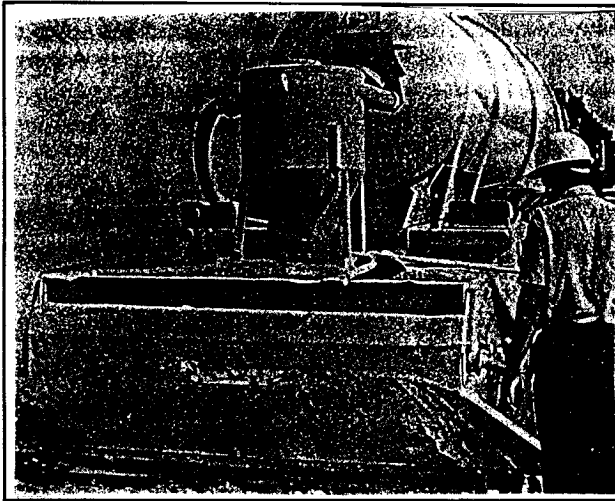

Figure G-9. Bulk mechanical spreader

(4) *Compaction, finishing, curing, and protection.* These construction techniques for mixed-in-place construction are essentially identical to those for central plant soil cement.

G-7. Quality Control, Inspection, and Testing

Adequate quality control and inspection procedures are important factors in successful soil-cement construction. Construction control procedures for soil-cement are fairly standardized. The quality of the two basic operations (soil-cement mixing and actual construction) are insured through control of four basic factors: cement content, moisture content, compaction, and curing. These factors can be controlled easily by organizing the inspection steps into a routine that fits in with the

sequence of construction steps. These steps are slightly different for central-plant construction and mixed-in-place construction.

a. Central-plant construction. The inspector checks on the following items.

(1) *Construction site and equipment.* Equipment must be clean, appropriate for the soil type, adjusted properly, and designed to preclude contamination introduction. Hauling vehicles must have protective covers where appropriate. The site should be set up to meet production and timing requirements and provide efficient traffic flow and proper separation distances for material stockpiles.

(2) *Soil.* Soil must match identification data given in the laboratory report. The inspector should check for uniformity of color, texture, and moisture. The soil should be monitored as it is stockpiled. Upon completion of the stockpile it is sampled and tested for acceptance. Gradation, specific gravity, and Atterberg limits should be tested regularly.

(3) *Cement application.* The amount of cement is specified either as a percentage of cement by weight of oven-dry soil material, or in pounds of cement per cubic foot of compact soil-cement. Pre-construction plant calibration and daily calibration checks insure an accurate mix. Different types of calibration procedures are applicable depending on the type of mixing plant used. In addition to plant calibration and daily checks of mix proportions, freshly mixed soil-cement cement content can be tested using a titration test and hardened soil-cement cement content can be tested using ASTM D 806.

(4) *Water Application.* Water is added at the central mixing plant in quantities sufficient to bring the mixture to the optimum moisture content as determined by a laboratory moisture-density test. Generally the moisture content should not be more than two percentage points below or above the specified optimum moisture. To estimate mixing water requirements stockpile moisture content is determined and additional water requirements calculated. Experienced inspectors can determine, in a qualitative way, the moisture requirements just prior to compaction by squeezing the mixture in the palm of the hand. A mixture near optimum moisture content is just moist enough to dampen the hands when packed tightly and can be broken in two with little or no crumbling. During compaction the surface of the material may dry out (indicated by a graying of the surface). Moisture is brought back to optimum by fog spraying.

(5) *Mix uniformity.* Uniformity is checked visually by noting color uniformity either at the plant or by digging a hole in the loosely placed material in the layer. If, due to lightness of soil material color, it is difficult to determine mixing, a 2 percent solution of phenolphthalein can be sprayed on a cut face of the material to determine if any cement is present. The cement in the mixture will turn treated material pinkish-red while untreated soil will retain its natural color.

(6) *Transporting and spreading.* Specified timing requirements for transporting and spreading should be monitored. Traffic patterns and possible material contamination (especially near layer edges and ramps) should be checked. Layer offset distances and layer thickness and uniformity should also be checked. The spreader should not be allowed to empty, but should be stopped while there is still mix left in the hopper. This insures uniform spreader operation.

(7) *Compaction.* Samples of the soil-cement are taken from the batch and prepared for laboratory moisture-density testing at the same time compaction is taking place. This accounts for timing parameters. In-place density testing is conducted as soon as possible after compaction in a spot where the laboratory material has been taken. Field and laboratory densities are then compared.

(8) *Curing.* Curing specifications and placement procedures should be closely monitored by the inspector. If water curing is used, the equipment must be capable of fog, rather than pressure, spraying. The surface must be kept continuously moist. Exposed surfaces should be cured for seven days. Curing times must be satisfied as well as provisions made in the case of freezing temperatures. Membrane cures must be of sufficient thickness to hold in moisture.

G-8. References

¹American Society for Testing and Materials 1999

American Society for Testing and Materials. (1993). *1993 Annual Book of Standards*, Philadelphia, PA.

¹ASTM C-150-98

American Society for Testing and Materials. 1998. "Specification for Portland Cement."

¹ASTM D-558-96

American Society for Testing and Materials. 1996a. "Test Methods for Moisture-density Relations of Soil-cement Mixtures."

¹ASTM D-559-96

American Society for Testing and Materials. 1996b. "Test Methods for Wetting and Drying Compacted Soil-cement Mixtures."

¹ASTM D-560-96

American Society for Testing and Materials. 1996c. "Test Methods for Freezing and Thawing Compacted Soil-cement Mixtures."

¹ASTM D-806-96

American Society for Testing and Materials. 1996d. "Test Method for Cement Content of Soil-cement Mixtures."

¹ Reference available through American Society for Testing and Materials, 1916 Race Street, Philadelphia, PA 19103.

¹ASTM D-1557-91

American Society for Testing and Materials. 1991. "Test Method for Laboratory Compaction Characteristics of Soil Using Modified Effort."

¹ASTM D-1632-96

American Society for Testing and Materials. 1996e. "Practice for Making and Curing Soil Cement Compression and Flexure Test Specimens in the Laboratory."

¹ASTM D-1633-96

American Society for Testing and Materials. 1996f. "Test Method for Compressive Strength of Molded Soil Cement Cylinders."

¹ASTM D-2487-93

American Society for Testing and Materials. 1993. "Classification of Soils for Engineering Purposes."

CRD-C-400

Corps of Engineers

Portland Cement Association 1995

Portland Cement Association. 1995. "Soil Cement Construction Handbook."

Appendix H Notation

The symbols that follow are used throughout this manual and correspond wherever possible to those recommended by the American Society of Civil Engineers.

Symbol	Term
c	Cohesion per unit area; a constant for natural top stratum where $c = \sqrt{\frac{k_{bl}}{k_f z_{bl} d}}$
c'	Effective cohesion in terms of effective stress
c_v	Coefficient of consolidation
C_c	Compression index
C_a	Coefficient of secondary compression
d	Effective thickness of pervious substratum
e	Void ratio
F_t	Transformation factor for permeability
h_o	Excess hydrostatic head
h'_o	Hydrostatic head beneath landside toe of levee
h_x	Hydrostatic head beneath top stratum
H	Net head
i_c	Critical gradient for landside top stratum
i_t	Upward gradient at landside toe of berm
i_o	Upward gradient at landside toe of levee
k	Coefficient of permeability
k_o	Coefficient of permeability (top stratum)
k_f	Average horizontal coefficient of permeability
k_n	Coefficient of permeability (vertical)
k_{bl}	Permeability of landside stratum
k_{br}	Permeability of riverside stratum
L_1	Distance from riverside levee toe to river
L_2	Base width of levee and berm
L_3	Length of top stratum landward of levee toe
M_d	Slope of hydraulic grade line

(Continued)

Symbol	Term
Q	Shear test for specimen tested at constant water content (unconsolidated-undrained)
Q_s	Total amount of seepage passing beneath levee
R	Shear test for specimen consolidated and then sheared at constant water content (consolidated-undrained)
s	(a) distance from the landside toe of the levee to the point of effective seepage entry (b) shear test for specimen consolidated and sheared without restriction of change in water content (consolidated-drained)
x_1	Effective length of riverside blanket
x_3	Distance from landside levee toe to effective seepage exit
z_b	Effective thickness of stratum
z_t	Transformed thickness of top stratum
z_{bl}	Effective thickness of landside top stratum
z_{br}	Effective thickness of riverside top stratum
z_{bt}	Effective thickness of top stratum
$\bar{\alpha}$	Wet unit weight of soil
$\bar{\alpha}_w$	Unit weight of water
$\bar{\alpha}'$	Submerged or buoyant unit weight of soil
$\bar{\phi}'$	Angle of internal friction based on effective stresses
$\$$	Shape factor to generalized cross section of the levee and foundation
